

# Mitsubishi Programmable Controller

## Analog-Digital Converter Module Type AJ65SBT2B-64AD User's Manual

---

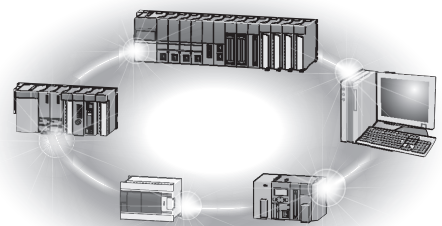



# ● SAFETY PRECAUTIONS ●

(Read these precautions before using this product.)

Before using this product, please read this manual and the relevant manuals carefully and pay full attention to safety to handle the product correctly.

The precautions given in this manual are concerned with this product only. For the safety precautions of the programmable controller system, refer to the user's manual for the CPU module used.

In this manual, the safety precautions are classified into two levels: "⚠ WARNING" and "⚠ CAUTION".



Indicates that incorrect handling may cause hazardous conditions, resulting in death or severe injury.



Indicates that incorrect handling may cause hazardous conditions, resulting in minor or moderate injury or property damage.

Under some circumstances, failure to observe the precautions given under "⚠ CAUTION" may lead to serious consequences.

Observe the precautions of both levels because they are important for personal and system safety.

Make sure that the end users read this manual and then keep the manual in a safe place for future reference.

## [Design Precautions]

### ⚠ WARNING

- In the case of a communication failure in the network, data in the master module are held. Check the communication status information and configure an interlock circuit in the sequence program to ensure that the entire system will operate safely.
- Do not use any "use prohibited" signals as a remote input or output signal. These signals are reserved for system use. If they are turned on/off by a user, correct operation of the module cannot be guaranteed.

### ⚠ CAUTION

- Do not install the control lines or communication cables together with the main circuit lines or power cables. Keep a distance of 100mm or more between them. Failure to do so may result in malfunction due to noise.

## [Installation Precautions]

### CAUTION

- Use the module in an environment that meets the general specifications in this manual.  
Failure to do so may result in electric shock, fire, malfunction, or damage to or deterioration of the product.
- For protection of the switches, do not remove the cushioning material before installation.
- Securely fix the module with a DIN rail or mounting screws. Tighten the screws within the specified torque range.  
Undertightening can cause drop of the screw, short circuit or malfunction.  
Overtightening can damage the screw and/or module, resulting in drop, short circuit, or malfunction.
- Do not directly touch any conductive part of the module.  
Doing so can cause malfunction or failure of the module.

## [Wiring Precautions]

### WARNING

- Shut off the external power supply (all phases) used in the system before wiring.  
Failure to do so may result in malfunction or damage to the product.

### CAUTION

- Ground the FG terminal to the protective ground conductor dedicated to the programmable controller.  
Failure to do so may result in electric shock or malfunction.
- Tighten any unused terminal screws within the specified torque range (0.42 to 0.50N·m). Failure to do so may cause a short circuit.
- Use applicable solderless terminals and tighten them within the specified torque range.  
If any spade solderless terminal is used, it may be disconnected when the terminal screw comes loose, resulting in failure.
- Check the rated voltage and terminal layout before wiring to the module, and connect the cables correctly.  
Applying a voltage or inputting a current that exceeds the absolute maximum input of the module, connecting a power supply with a different voltage rating, or wiring the cables incorrectly may cause a fire or failure.
- Tighten the terminal screw within the specified torque range.  
Undertightening can cause short circuit, fire, or malfunction.  
Overtightening can damage the screw and/or module, resulting in drop, short circuit, or malfunction.

## [Wiring Precautions]

### CAUTION

- Prevent foreign matter such as dust or wire chips from entering the module.  
Such foreign matter can cause a fire, failure, or malfunction.
- Place the cables in a duct or clamp them.  
If not, dangling cable may swing or inadvertently be pulled, resulting in damage to the module or cables or malfunction due to poor contact.
- Do not install the control lines or communication cables together with the main circuit lines or power cables.  
Doing so may result in malfunction due to noise.
- When disconnecting the cable from the module, do not pull the cable by the cable part.  
Loosen the screws of connector before disconnecting the cable.  
Failure to do so may result in damage to the module or cable or malfunction due to poor contact.

## [Startup and Maintenance Precautions]

### WARNING

- Do not touch any terminal while power is on.  
Doing so will cause electric shock or malfunction.
- Shut off the external power supply (all phases) used in the system before cleaning the module or retightening the terminal screws or module mounting screws.  
Failure to do so may cause the module to fail or malfunction.  
Undertightening can cause drop of the screw, short circuit or malfunction.  
Overtightening can damage the screw and/or module, resulting in drop, short circuit, or malfunction.

## [Startup and Maintenance Precautions]

### CAUTION

- Do not disassemble or modify the module.  
Doing so may cause failure, malfunction, injury, or a fire.
- Use any radio communication device such as a cellular phone or PHS (Personal Handy-phone System) more than 25cm away in all directions from the module.  
Failure to do so may cause malfunction.
- Do not drop or apply strong shock to the module.  
Doing so may damage the module.
- Shut off the external power supply for the system in all phases before installing or removing a module to/from a control panel.  
Failure to do so may cause the module to fail or malfunction.
- After the first use of the product, do not mount/remove the terminal block to/from the module more than 50 times (IEC 61131-2 compliant).  
Exceeding the limit of 50 times may cause malfunction.
- Before handling the module, touch a grounded metal object to discharge the static electricity from the human body. Failure to do so may cause the module to fail or malfunction.

## [Disposal Precaution]

### CAUTION

- When disposing of this product, treat it as industrial waste.

# ● CONDITIONS OF USE FOR THE PRODUCT ●

- (1) Mitsubishi programmable controller ("the PRODUCT") shall be used in conditions;
  - i) where any problem, fault or failure occurring in the PRODUCT, if any, shall not lead to any major or serious accident; and
  - ii) where the backup and fail-safe function are systematically or automatically provided outside of the PRODUCT for the case of any problem, fault or failure occurring in the PRODUCT.
  
- (2) The PRODUCT has been designed and manufactured for the purpose of being used in general industries.

MITSUBISHI SHALL HAVE NO RESPONSIBILITY OR LIABILITY (INCLUDING, BUT NOT LIMITED TO ANY AND ALL RESPONSIBILITY OR LIABILITY BASED ON CONTRACT, WARRANTY, TORT, PRODUCT LIABILITY) FOR ANY INJURY OR DEATH TO PERSONS OR LOSS OR DAMAGE TO PROPERTY CAUSED BY the PRODUCT THAT ARE OPERATED OR USED IN APPLICATION NOT INTENDED OR EXCLUDED BY INSTRUCTIONS, PRECAUTIONS, OR WARNING CONTAINED IN MITSUBISHI'S USER, INSTRUCTION AND/OR SAFETY MANUALS, TECHNICAL BULLETINS AND GUIDELINES FOR the PRODUCT.

("Prohibited Application")

Prohibited Applications include, but not limited to, the use of the PRODUCT in;

- Nuclear Power Plants and any other power plants operated by Power companies, and/or any other cases in which the public could be affected if any problem or fault occurs in the PRODUCT.
- Railway companies or Public service purposes, and/or any other cases in which establishment of a special quality assurance system is required by the Purchaser or End User.
- Aircraft or Aerospace, Medical applications, Train equipment, transport equipment such as Elevator and Escalator, Incineration and Fuel devices, Vehicles, Manned transportation, Equipment for Recreation and Amusement, and Safety devices, handling of Nuclear or Hazardous Materials or Chemicals, Mining and Drilling, and/or other applications where there is a significant risk of injury to the public or property.

Notwithstanding the above, restrictions Mitsubishi may in its sole discretion, authorize use of the PRODUCT in one or more of the Prohibited Applications, provided that the usage of the PRODUCT is limited only for the specific applications agreed to by Mitsubishi and provided further that no special quality assurance or fail-safe, redundant or other safety features which exceed the general specifications of the PRODUCTS are required. For details, please contact the Mitsubishi representative in your region.

## REVISIONS

\* The manual number is given on the bottom left on the back cover.

Print date	*Manual number	Revision
May, 2011	SH(NA)-080979ENG-A	First edition
Oct., 2014	SH(NA)-080979ENG-B	<div style="border: 1px solid black; display: inline-block; padding: 2px;">Correction</div> MANUALS, COMPLIANCE WITH THE EMC AND LOW VOLTAGE DIRECTIVES, Section 2.2, 3.1, 4.3, Appendix 1  <div style="border: 1px solid black; display: inline-block; padding: 2px;">addition</div> GENERIC TERMS AND ABBREVIATIONS, Section 2.4

Japanese manual version SH-080965-B

This manual confers no industrial property rights or any rights of any other kind, nor does it confer any patent licenses. Mitsubishi Electric Corporation cannot be held responsible for any problem involving industrial property rights which may occur as a result of using the contents noted in this manual.

© 2011 MITSUBISHI ELECTRIC CORPORATION



## INTRODUCTION

Thank you for purchasing the Mitsubishi programmable controllers.

Before using this product, please read this manual carefully and develop familiarity with the functions and performance of the programmable controller to handle the product correctly.

## CONTENTS

SAFETY PRECAUTIONS .....	A - 1
CONDITIONS OF USE FOR THE PRODUCT .....	A - 5
REVISIONS.....	A - 6
INTRODUCTION.....	A - 7
CONTENTS .....	A - 7
MANUALS.....	A - 10
COMPLIANCE WITH THE EMC AND LOW VOLTAGE DIRECTIVES.....	A - 10
GENERIC TERMS AND ABBREVIATIONS.....	A - 11
PACKING LIST .....	A - 13

---

### CHAPTER 1 OVERVIEW 1 - 1 to 1 - 2

---

1.1 Features.....	1 - 1
-------------------	-------

---

### CHAPTER 2 SYSTEM CONFIGURATION 2 - 1 to 2 - 3

---

2.1 Overall Configuration .....	2 - 1
2.2 Applicable System .....	2 - 2
2.3 Checking the Hardware Version .....	2 - 3
2.4 Checking the Serial Number.....	2 - 3

---

### CHAPTER 3 SPECIFICATIONS 3 - 1 to 3 - 21

---

3.1 General Specifications.....	3 - 1
3.2 Performance Specifications .....	3 - 2
3.3 I/O Conversion Characteristics .....	3 - 3
3.3.1 Voltage input characteristics.....	3 - 4
3.3.2 Current input characteristics.....	3 - 6
3.3.3 Accuracy.....	3 - 8
3.3.4 Conversion speed.....	3 - 8
3.4 Functions .....	3 - 9
3.4.1 Function list .....	3 - 9
3.4.2 A/D conversion enable/disable function .....	3 - 10
3.4.3 Sampling processing/average processing specification .....	3 - 11
3.4.4 Input range setting function .....	3 - 15
3.5 Remote I/O Signals.....	3 - 16
3.5.1 List of remote I/O signals.....	3 - 16
3.5.2 Details on each remote I/O signal .....	3 - 17
3.6 Remote Register.....	3 - 21
3.6.1 List of remote register assignments.....	3 - 21

3.6.2	Details of remote register.....	3 - 21
-------	---------------------------------	--------

---

**CHAPTER 4 SETTINGS AND THE PROCEDURE BEFORE OPERATION** **4 - 1 to 4 - 14**

---

4.1	The Procedure Before Operation.....	4 - 1
4.2	Handling Precautions.....	4 - 2
4.3	Part Names.....	4 - 4
4.3.1	Transmission speed auto-tracking function.....	4 - 7
4.4	Station Number Setting.....	4 - 8
4.5	Module Mounting Direction.....	4 - 8
4.6	Wiring of Data Link Cables.....	4 - 9
4.6.1	Wiring precautions.....	4 - 9
4.6.2	Connecting modules using CC-Link dedicated cables.....	4 - 9
4.6.3	Connecting terminating resistors.....	4 - 9
4.7	Wiring with External Devices.....	4 - 10
4.7.1	Wiring precautions.....	4 - 10
4.7.2	Wiring with external devices.....	4 - 11
4.8	Offset/gain Setting.....	4 - 12
4.9	Maintenance and Inspection.....	4 - 14

---

**CHAPTER 5 PROGRAMMING** **5 - 1 to 5 - 24**

---

5.1	Programming Procedure.....	5 - 1
5.2	Conditions of Program Examples.....	5 - 2
5.3	Program Example When Using the QCPU (Q mode).....	5 - 4
5.4	Program Example When Using the LCPU.....	5 - 9
5.5	Program Example When Using the QnACPU.....	5 - 12
5.6	Program Example When Using the ACPU/QCPU (A mode) (Dedicated Instructions).....	5 - 17
5.7	Program Example When Using the ACPU/QCPU (A mode) (FROM/TO Instructions).....	5 - 21

---

**CHAPTER 6 TROUBLESHOOTING** **6 - 1 to 6 - 7**

---

6.1	Error Check Method by the LED Display.....	6 - 1
6.2	When the Digital Output Value Cannot Be Read.....	6 - 4
6.3	When the Data Link Needs a Lot of Time.....	6 - 4
6.4	Troubleshooting When the ERR. LED of the Master Station Flashes.....	6 - 5
6.5	When Hardware Error Flag (RXnA) Turns on.....	6 - 7
6.6	When User Range Read Error Flag (RXnB) Turns on.....	6 - 7
6.7	When Flash Memory Write Error Flag (RXnC) Turns on.....	6 - 7
6.8	When Number of Offset/Gain Settings Excess Flag (RXnD) Turns on.....	6 - 7

---

**APPENDIX** **App - 1 to App - 2**

---

Appendix 1	External Dimensions.....	App - 1
------------	--------------------------	---------



## **MANUALS**

The manuals related to this product are listed below.  
Please place an order as needed.

Relevant manuals
------------------

<b>Manual name</b>	<b>Manual number (model name)</b>
CC-Link System Master/Local Module Type AJ61BT11/A1SJ61BT11 User's Manual System configuration, performance specifications, functions, handling, wiring, and troubleshooting of the AJ61BT11 and A1SJ61BT11 (Sold separately)	IB-66721 (13J872)
CC-Link System Master/Local Module Type AJ61QBT11/A1SJ61QBT11 User's Manual System configuration, performance specifications, functions, handling, wiring, and troubleshooting of the AJ61QBT11 and A1SJ61QBT11 (Sold separately)	IB-66722 (13J873)
MELSEC-Q CC-Link System Master/Local Module User's Manual System configuration, performance specifications, functions, handling, wiring, and troubleshooting of the CC-Link module (Sold separately)	SH-080394E (13JR64)
MELSEC-L CC-Link System Master/Local Module User's Manual System configuration, performance specifications, functions, handling, wiring, and troubleshooting of the LCPU with built-in CC-Link and LJ61BT11 (Sold separately)	SH-080895ENG (13JZ41)
MELSEC iQ-R CC-Link System Master/Local Module User's Manual (Application) Functions, parameter settings, programming, troubleshooting, I/O signals, and buffer memory of the CC-Link system master/local module	SH-081270ENG (13JX19)
Type AnSHCPU/AnACPU/AnUCPU/QCPU-A (A Mode) Programming Manual (Dedicated Instructions) Instructions extended for the AnSHCPU/AnACPU/AnUCPU (Sold separately)	IB-66251 (13J742)
MELSEC iQ-R Programming Manual (Instructions, Standard Functions/Function Blocks) Instructions for the CPU module, dedicated instructions for the intelligent function modules, and standard functions/function blocks	SH-081266ENG ---

## **COMPLIANCE WITH THE EMC AND LOW VOLTAGE DIRECTIVES**

### (1) Method of ensuring compliance

To ensure that Mitsubishi programmable controllers maintain EMC and Low Voltage Directives when incorporated into other machinery or equipment, certain measures may be necessary. Please refer to one of the following manuals.

- User's manual for the CPU module or head module used
- Safety Guidelines

(This manual is included with the CPU module, base unit, or head module.)

The CE mark on the side of the programmable controller indicates compliance with EMC and Low Voltage Directives.

### (2) Additional measures

To ensure that this product maintains EMC and Low Voltage Directives, please refer to one of the manuals listed under (1).

## **GENERIC TERMS AND ABBREVIATIONS**

Unless otherwise specified, the following generic terms and abbreviations are used in this manual to describe the AJ65SBT2B-64AD analog-digital converter module.

<b>Generic term/ abbreviation</b>	<b>Description</b>
GX Developer GX Works2	The product name of the software package for the MELSEC programmable controllers
Programming tool	A generic term for GX Works2 and GX Developer
ACPU	A generic term for the following CPU modules: A0J2CPU, A0J2HCPU, A1CPU, A2CPU, A2CPU-S1, A3CPU, A1SCPU, A1SCPUC24-R2, A1SHCPU, A1SJCPU, A1SJCPU-S3, A1SJHCPU, A1NCP, A2NCP, A2NCP-S1, A3NCP, A3MCP, A3HCP, A2SCP, A2SHCP, A2ACP, A2ACP-S1, A3ACP, A2UCP, A2UCP-S1, A2USCP, A2USCP-S1, A2USHCP-S1, A3UCP, and A4UCP
QnACPU	A generic term for the following CPU modules: Q2ACP, Q2ACP-S1, Q2ASCP, Q2ASCP-S1, Q2ASHCP, Q2ASHCP-S1, Q3ACP, Q4ACP, and Q4ARCP
QCPU (A mode)	A generic term for the Q02CPU-A, Q02HCP-A, and Q06HCP-A
QCPU (Q mode)	A generic term for the following CPU modules: Q00JCP, Q00UJCP, Q00CP, Q00UCP, Q01CP, Q01UCP, Q02CP, Q02HCP, Q02PHCP, Q02UCP, Q03UDCP, Q03UDECP, Q03UDVCP, Q04UDHCP, Q04UDEHCP, Q04UDVCP, Q06HCP, Q06PHCP, Q06UDHCP, Q06UDEHCP, Q06UDVCP, Q10UDHCP, Q10UDEHCP, Q12HCP, Q12PHCP, Q12PRHCP, Q13UDHCP, Q13UDEHCP, Q13UDVCP, Q20UDHCP, Q20UDEHCP, Q25HCP, Q25PHCP, Q25PRHCP, Q26UDHCP, Q26UDEHCP, Q26UDVCP, Q50UDEHCP, and Q100UDEHCP
LCPU	A generic term for the L02SCP, L02SCP-P, L02CP, L02CP-P, L06CP, L06CP-P, L26CP, L26CP-P, L26CP-BT, and L26CP-PBT
RCPU	A generic term for R04CP, R08CP, R16CP, R32CP, and R120CP
Master station	A station that controls a data link system. One master station is required for one system.
Local station	A station that includes a CPU module and can communicate with the master station and other local stations
Remote I/O station	A station, such as AJ65BTB1-16D and AJ65SBTB1-16D, that exchanges I/O signals (bit data) with an external device
Remote device station	A station that exchanges I/O signals (bit data) and I/O data (word data) with an external device, and converts analog data into digital data
Remote station	A generic term for a remote I/O station and a remote device station
Intelligent device station	A station, such as the AJ65BT-R2N, that can perform transient transmission. Local stations are included.
Master module	A generic term for modules that can serve as a master station
SB	Link special relay (for CC-Link) Bit data that indicates the operating status and data link status of modules on the master and local stations
SW	Link special register (for CC-Link) Word data that indicates the operating status and data link status of modules on the master and local stations
RX	Remote input (for CC-Link) Bit data input from a remote station to the master station
RY	Remote output (for CC-Link) Bit data output from the master station to a remote station
RWw	Remote register (write area for CC-Link) Word data output from the master station to a remote device station

Generic term/ abbreviation	Description
RWr	Remote register (read area for CC-Link) Word data input from a remote device station to the master station

**PACKING LIST**

The following items are included in the package of this product.

<b>Product</b>	<b>Quantity</b>
AJ65SBT2B-64AD analog-digital converter module	1
Analog-Digital Converter Module User's Manual (Hardware) Type AJ65SBT2B-64AD	1





## CHAPTER 1 OVERVIEW

This user's manual explains the specifications, operations, and programming method of the AJ65SBT2B-64AD analog-digital converter module (hereafter abbreviated as AJ65SBT2B-64AD) used as a remote device station of a CC-Link system.

The AJ65SBT2B-64AD changes analog values (voltage or current) to digital values (16-bit signed binary).

### 1.1 Features

This section describes the features of the AJ65SBT2B-64AD.

- (1) A/D conversion by one module with 4 channels  
One module enables an A/D conversion with 4 channels.
- (2) Input range setting for each channel  
I/O conversion characteristics can be changed by setting an analog input range in each channel.
- (3) Response by high-speed conversion  
High-speed conversion of 200 $\mu$ s/channel is achieved.
- (4) High resolution  
In all analog input ranges, high resolution of 1/16000 is achieved.
- (5) High accuracy  
The module performs an A/D conversion in accuracy of  $\pm 0.2\%^{*1}$  at the maximum digital output value when the operating ambient temperature is within 0 to 55°C.  
\* 1 Except when receiving noise influence.
- (6) Selecting the conversion method  
A conversion processing method for each channel can be selected from the sampling processing, time average processing, count average processing or moving average processing.
- (7) Saving man-hour
  - (a) Since the module has a built-in terminating resistor (110 $\Omega$ ), a terminating resistor is not necessary when the module is used on the network terminal. In addition, one operation with a switch can make the built-in terminating resistor invalid.
  - (b) The transmission speed need not be set by the user since it is automatically determined according to the transmission speed set in a master station.
  - (c) The offset/gain setting can be configured by simple operations without the connection to the master module.

(8) Connection with up to 42 modules

A master station can connect with up to 42 AJ65SBT2B-64ADs.

(9) Easy maintenance

The structure of the two-piece terminal block enables the user to remove a terminal block with wiring unchanged for easy maintenance.

## CHAPTER 2 SYSTEM CONFIGURATION

This chapter describes the system configuration when using the AJ65SBT2B-64AD.

### 2.1 Overall Configuration

The following Figure 2.1 shows an overall configuration when using the AJ65SBT2B-64AD.

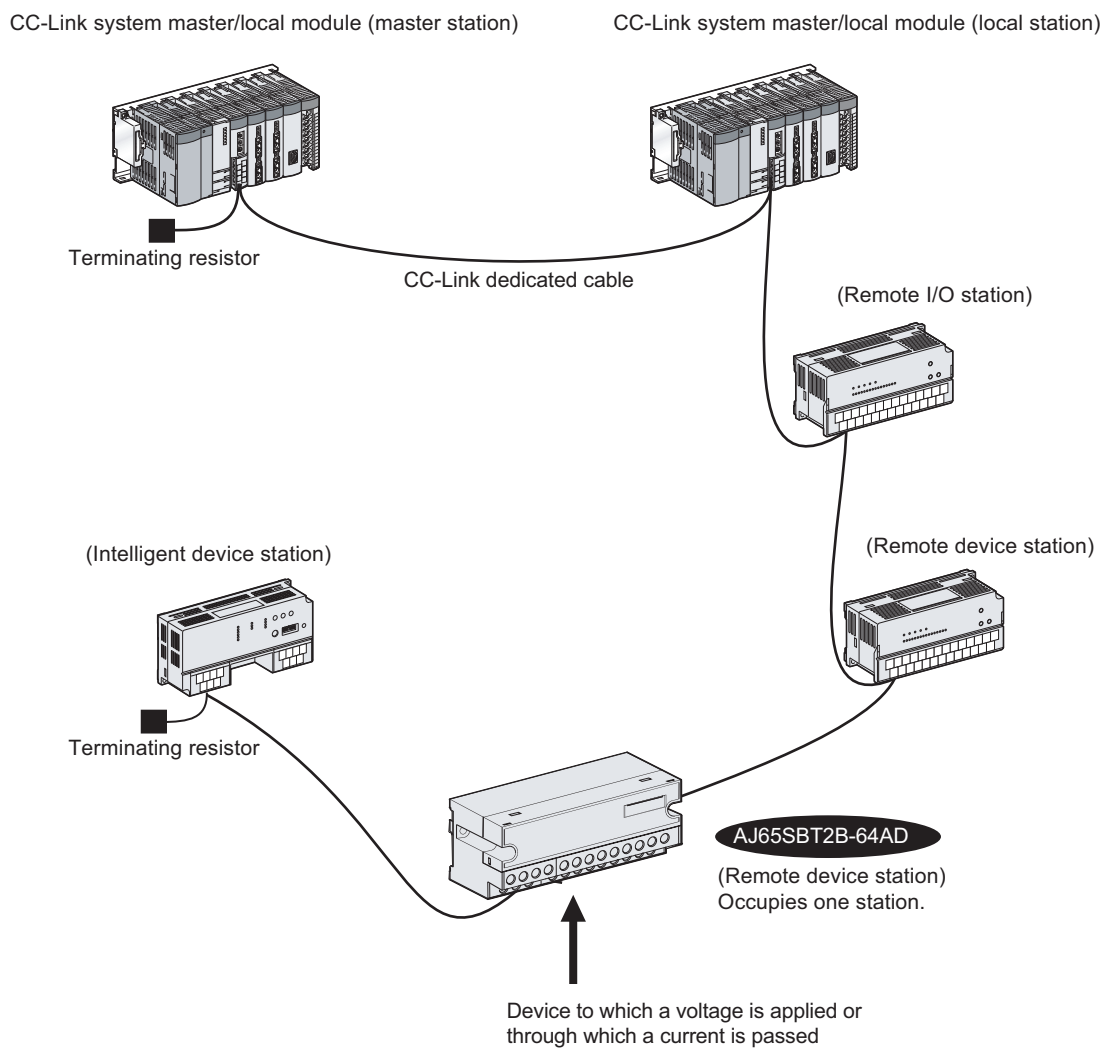

Figure 2.1 Overall configuration when using the AJ65SBT2B-64AD

## 2.2 Applicable System

---

The applicable master modules are described in the website of CC-Link Partner Association (CLPA). Refer to the following URL for the website of CC-Link Partner Association (CLPA).

[www.cc-link.org](http://www.cc-link.org)

**Remark** .....

Before using the module, check the specifications of the master module made by each manufacturer.

.....

(1) Restrictions to use the dedicated instruction for CC-Link (RLPA, RRPA)

The dedicated instruction (RLPA, RRPA) for CC-Link may not be available depending on the CPU module or master module to be used.

Refer to the following manuals for details on restrictions:

- User's manual for an A series master module
- Type AnSHCPU/AnACPU/AnUCPU/QCPU-A(A Mode) Programming Manual (Dedicated Instructions)

Any dedicated instructions except RLPA or RRPA are not applicable for the AJ65SBT2B-64AD.

Refer to Section 5.6 for an example of the program using the dedicated instructions (RLPA and RRPA).

## 2.3 Checking the Hardware Version

The hardware version of the AJ65SBT2B-64AD can be checked in the DATE section on the rating plate.

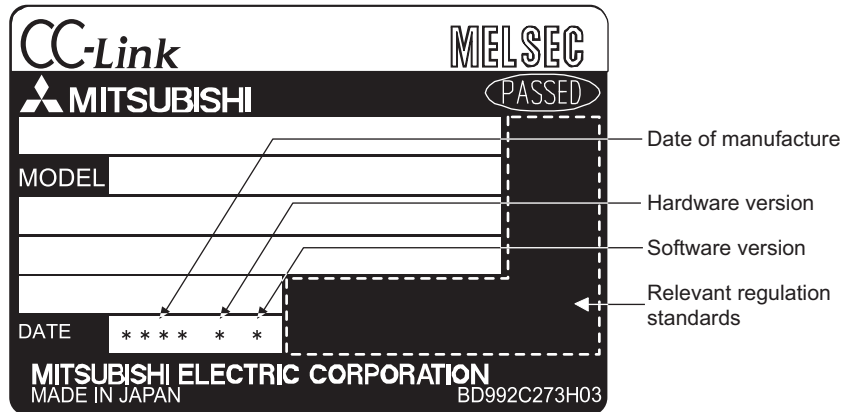

Figure 2.2 Checking the hardware version

## 2.4 Checking the Serial Number

The serial number of the AJ65SBT2B-64AD can be checked in the SERIAL section on the rating plate.

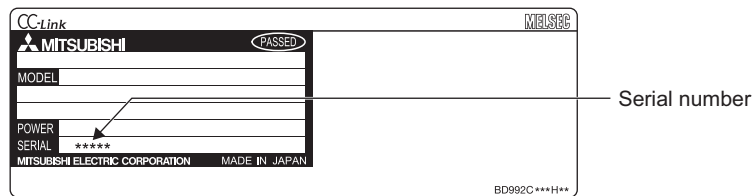

Figure 2.3 Checking the serial number

## CHAPTER 3 SPECIFICATIONS

This chapter describes the specifications of the AJ65SBT2B-64AD.

### 3.1 General Specifications

This section lists the general specifications of the AJ65SBT2B-64AD.

**Table 3.1 General specifications**

Item	Specifications					
Operating ambient temperature	0 to 55°C					
Storage ambient temperature	-20 to 75°C					
Operating ambient humidity	10 to 90%RH, non-condensing					
Storage ambient humidity						
Vibration resistance	Compliant with JIS B 3502, IEC 61131-2	Under intermittent vibration	Frequency	Constant acceleration	Half amplitude	Sweep count
			5 to 8.4Hz	-	3.5mm	10 times each in X, Y, Z directions
		8.4 to 150Hz	9.8m/s <sup>2</sup>	-		
		Under continuous vibration	5 to 8.4Hz	-	1.75mm	-
8.4 to 150Hz	4.9m/s <sup>2</sup>		-			
Shock resistance	Compliant with JIS B 3502 and IEC 61131-2 (147 m/s <sup>2</sup> , 3 times each in 3 directions X, Y, Z)					
Operating atmosphere	No corrosive gases					
Operating altitude* <sup>1</sup>	0 to 2000m					
Installation location	Inside a control panel					
Overvoltage category* <sup>2</sup>	II or lower					
Pollution degree* <sup>3</sup>	2 or less					

\* 1 Do not use or store the programmable controller under pressure higher than the atmospheric pressure of altitude 0m. Doing so may cause malfunction. When using the programmable controller under pressure, please consult your local Mitsubishi Electric representative.

\* 2 This indicates the section of the power supply to which the equipment is assumed to be connected between the public electrical power distribution network and the machinery within premises.

Category II applies to equipment for which electrical power is supplied from fixed facilities. The surge voltage withstand level for up to the rated voltage of 300V is 2500V.

\* 3 This index indicates the degree to which conductive material is generated in terms of the environment in which the equipment is used. Pollution level 2 is when only non-conductive pollution occurs. A temporary conductivity caused by condensing must be expected occasionally.

## 3.2 Performance Specifications

This section lists the performance specifications of the AJ65SBT2B-64AD.

**Table 3.2 Performance specifications**

Item		AJ65SBT2B-64AD			
Analog input	Voltage	-10 to 10VDC (Input resistance: 1MΩ)			
	Current	0 to 20mADC (Input resistance: 250Ω)			
Digital output		16-bit signed binary (-16384 to 16383)			
I/O characteristics, resolution, accuracy (accuracy at the maximum digital output value)	Voltage	Analog input range	Digital output value	Accuracy*1 (ambient temperature: 0 to 55°C)	Resolution
		-10 to 10V	-16000 to 16000		0.625mV
		User range setting 1 (-10 to 10V)			0.5mV <sup>*2</sup>
		User range setting 2 (-5 to 5V)			0.25mV <sup>*2</sup>
		0 to 5V	0 to 16000		0.3125mV
	1 to 5V	0.25mV			
	Current	0 to 20mA	0 to 16000	±0.2% (±32 digits)	1.25μA
		4 to 20mA			1μA
		User range setting 2	-16000 to 16000		1μA <sup>*2</sup>
	Conversion speed		200μs/channel		
Absolute maximum input		Voltage: ±15V Current: ±30mA <sup>*3</sup>			
Number of analog input points		4 channels			
Number of offset/gain setting times <sup>*4</sup>		Max. 10,000 times			
CC-Link version		CC-Link Ver.1.10			
CC-Link station type		Remote device station			
Number of occupied stations		1 station			
Connection cable		CC-Link dedicated cable			
Withstand voltage		500VAC for 1 minute between all power supply and communication system terminals and all analog input terminals			
Insulation method		Between communication system terminal and all analog input terminals: Photocoupler isolation Between power supply system terminal and all analog input terminals: Transformer insulation Between input channels: Non-insulation			
Noise immunity		Noise voltage 500Vp-p, noise width 1μs, noise frequency 25 to 60Hz (DC type noise simulator condition)			
Built-in terminating resistor		Provided (110Ω)			
External connection system	Communication part, module power supply part	7-point two-piece terminal block M3 × 5.2 screw (tightening torque range: 0.59 to 0.88N·m) Applicable solderless terminal: 2 or less			
	I/O part	18-point two-piece terminal block M3 × 5.2 screw (tightening torque range: 0.59 to 0.88N·m) Applicable solderless terminal: 2 or less			
Applicable wire size		0.3 to 2.0mm <sup>2</sup>			

Table 3.2 Performance specifications

Item	AJ65SBT2B-64AD
Applicable solderless terminal	•RAV1.25-3 (compliant with JIS C 2805) [Applicable wire size: 0.3 to 1.25mm <sup>2</sup> ] •V2-MS3, RAP2-3SL, TGV2-3N [Applicable wire size: 1.25 to 2.0mm <sup>2</sup> ]
Module mounting screw	M4 screw × 0.7mm × 16mm or more (tightening torque range: 0.78 to 1.08 N•m) Mountable with a DIN rail
Applicable DIN rail	TH35-7.5Fe, TH35-7.5Al (compliant with IEC 60715)
External power supply	24VDC (20.4 to 28.8VDC)
	Inrush current: 16A, 4.0ms or less
	Current consumption: 0.12A (24VDC)
Weight	0.25kg

\* 1 Except when receiving noise influence.

\* 2 These values indicate the maximum resolution with user range setting.

\* 3 This value indicates a momentary input current value at which the built-in resistor will not be broken.

\* 4 The number of times that the SELECT/SET switch is set to SET in test mode.

### 3.3 I/O Conversion Characteristics

The I/O conversion characteristics are the gradient of a straight line connecting an offset value and a gain value when an analog signal (voltage or current input) from outside the programmable controller is converted to a digital value.

The offset value is an analog input value (voltage or current) which turns 0 as a digital output value after conversion.

The gain value is an analog input value (voltage or current) which turns 16000 as a digital output value after conversion.



## 3.3.1 Voltage input characteristics

Figure 3.1 shows the graph of the voltage input characteristics.

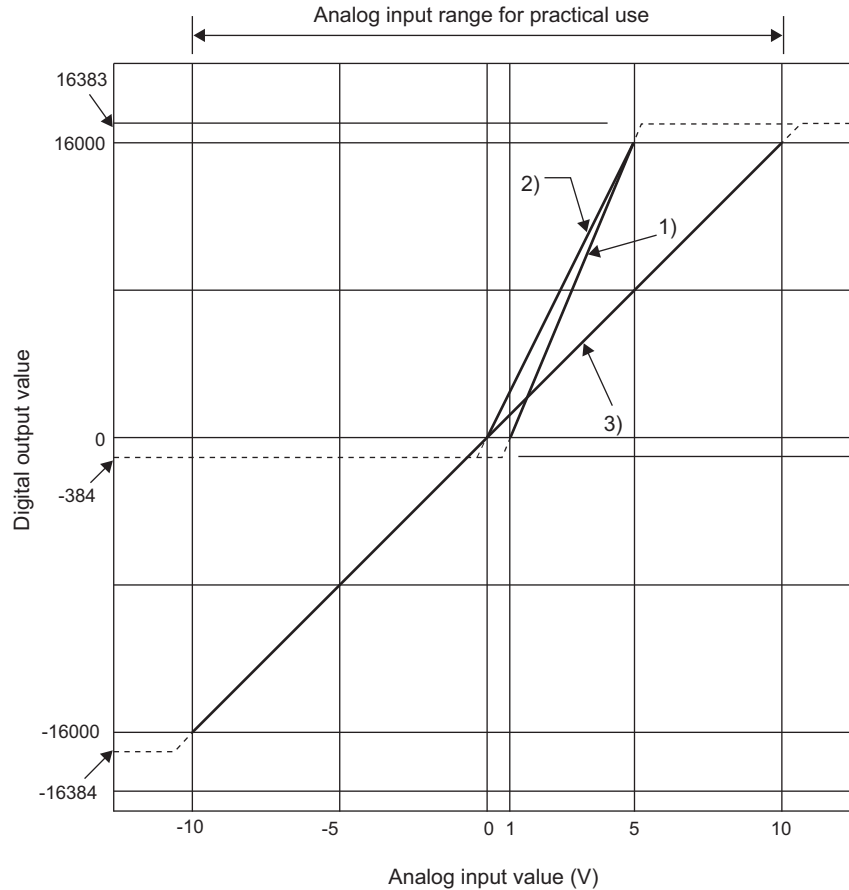

Figure 3.1 Voltage input characteristics diagram

Table 3.3 Voltage input characteristics table

No.	Analog input range setting	Offset value	Gain value	Digital output value	Resolution
1)	1 to 5V	1V	5V	0 to 16000	0.25mV
2)	0 to 5V	0V	5V		0.3125mV
3)	-10 to 10V	0V	10V		0.625mV
-	User range setting 1 (-10 to 10V)	-	-	-16000 to 16000	0.5mV* <sup>1</sup>
-	User range setting 2 (-5 to 5V)	-	-		0.25mV* <sup>1</sup>

\* 1 These values indicate the maximum resolution with user range setting.

### POINT

- (1) When values are within the analog input range and the digital output range, the resolution and accuracy are maintained within the range of performance specifications.  
If the values exceed these ranges, the resolution and the accuracy of performance specifications may not be maintained. (Avoid using the values on the dotted lines in Figure 3.1.)
- (2) Do not input  $\pm 15V$  or more. Doing so may damage the elements.
- (3) Set the offset and gain values of the user range setting 1 or 2 within the range satisfying the following conditions.

[User range setting 1]

- (a) The setting range of the offset value and gain value:  $-10$  to  $10V^{*1}$
- (b)  $(\text{Gain value}) > (\text{Offset value})^{*2}$
- (c)  $(\text{Gain value}) - (\text{Offset value}) > 8V^{*3}$

\*1 For the analog input range of  $-5$  to  $5V$ , use the user range setting 2. Less variation of the digital output values can be acquired, compared with the case using the user setting range 1.

\*2 In case of  $(\text{Gain value}) \leq (\text{Offset value})$ , RUN LED flashes at intervals of  $0.5s$ . After turning on Error reset request flag (RY(n+1)A) to reset the error, set values again.

\*3 Setting values within the range of  $(\text{Gain value}) - (\text{Offset value}) \leq 8V$  may cause large variations in the digital output values.

[User range setting 2]<sup>\*4</sup>

- (a) The setting range of the offset value or gain value:  $-5$  to  $5V$ .
- (b)  $(\text{Gain value}) > (\text{Offset value})^{*5}$
- (c)  $(\text{Gain value}) - (\text{Offset value}) > 4V^{*6}$

\*4 In the user range setting 2, either current or voltage can be used by changing the wiring. To use the voltage in the user range setting 2, set "I" of the offset/gain adjustment LED.

\*5 In case of  $(\text{Gain value}) \leq (\text{Offset value})$ , RUN LED flashes at intervals of  $0.5s$ . After turning on Error reset request flag (RY(n+1)A) to reset the error, set values again.

\*6 Setting values within the range of  $(\text{Gain value}) - (\text{Offset value}) \leq 4V$  may cause large variations in the digital output values.

- (4) When the analog input exceeds the range of digital output values in Table 3.3, the digital output value is fixed to the maximum or minimum value.

**Table 3.4 The digital output values when the analog input exceeds the range of digital output values**

Analog input range setting	Digital output value	
	Minimum	Maximum
1 to 5V	-384	16383
0 to 5V		
-10 to 10V		
User range setting 1 (-10 to 10V)	-16384	16383
User range setting 2 (-5 to 5V)		

## 3.3.2 Current input characteristics

Figure 3.2 shows the graph of the voltage input characteristics.

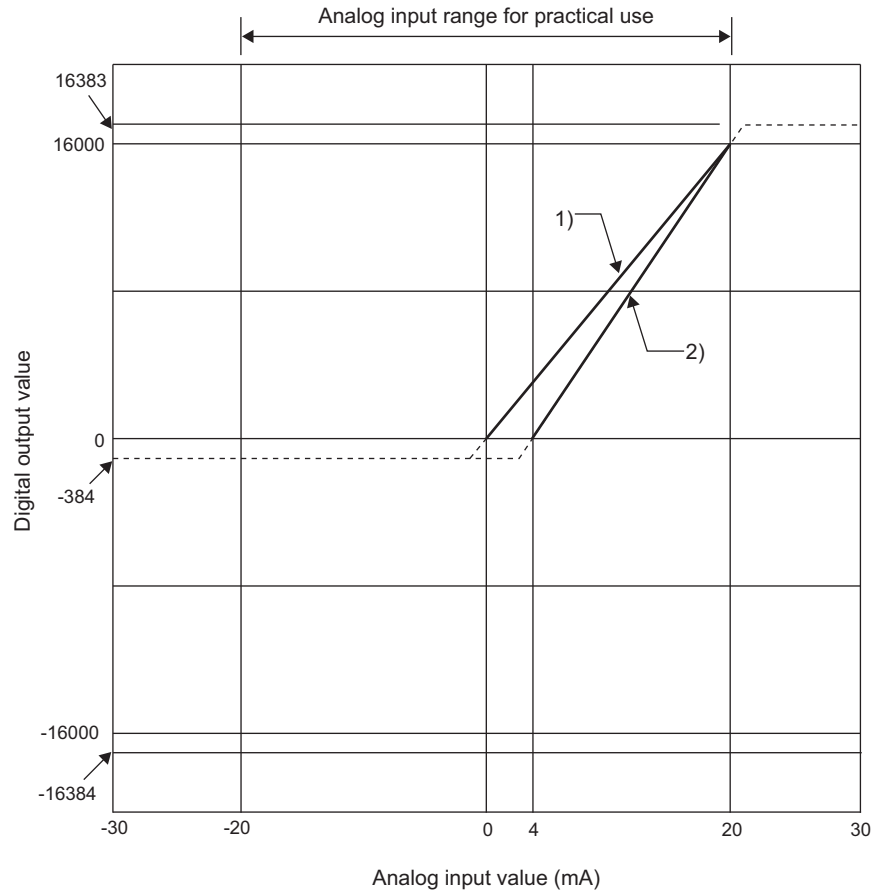

Figure 3.2 Current conversion characteristics diagram

Table 3.5 Current conversion characteristics table

No.	Analog input range setting	Offset value	Gain value	Digital output value	Resolution
1)	0 to 20mA	0mA	20mA	0 to 16000	1.25μA
2)	4 to 20mA	4mA	20mA		1μA
-	User range setting 2	-	-	-16000 to 16000	1μA*1

\* 1 This value indicates the maximum resolution with user range setting.

**POINT**

- (1) When values are within the analog input range and the digital output range, the resolution and accuracy are maintained within the range of performance specifications.

If the values exceed these ranges, the resolution and the accuracy of performance specifications may not be maintained. (Avoid using the values on the dotted lines in Figure 3.2.)

- (2) Do not input  $\pm 30\text{mA}$  or more. Doing so may damage the elements.  
 (3) Set the offset and gain values of the user range setting 2 within the range satisfying the following conditions.

[User range setting 2]

(a) The setting range of the offset value or gain value:  $-20$  to  $20\text{mA}$ .

(b)  $(\text{Gain value}) > (\text{Offset value})^{*1}$

(c)  $(\text{Gain value}) - (\text{Offset value}) > 16\text{mA}^{*2}$

\*1 In case of  $(\text{Gain value}) \leq (\text{Offset value})$ , RUN LED flashes at intervals of 0.5s. After turning on Error reset request flag (RY(n+1)A) to reset the error, set values again.

\*2 Setting values within the range of  $(\text{Gain value}) - (\text{Offset value}) \leq 16\text{mA}$  may cause large variations in the digital output values.

- (4) When the analog input exceeds the range of digital output values in Table 3.5, the digital output value is fixed to the maximum or minimum value.

**Table 3.6 The digital output values when the analog input exceeds the range of digital output values**

Analog input range setting	Digital output value	
	Minimum	Maximum
0 to 20mA	-384	16383
4 to 20mA		
User range setting 2	-16384	

## 3.3.3 Accuracy

The accuracy of A/D conversion is measured for the maximum digital output value. Even when the input characteristics are changed by modifying the offset/gain setting or the input range, the accuracy remains the same and maintained within the range described in the performance specifications in Section 3.2.

Figure 3.3 shows a variation range of the accuracy when using the -10 to 10V range. When the operating ambient temperature is 0 to 55°C, a digital value is output with the accuracy within  $\pm 0.2\%$  ( $\pm 32$ digit). (Except when receiving noise influence.)

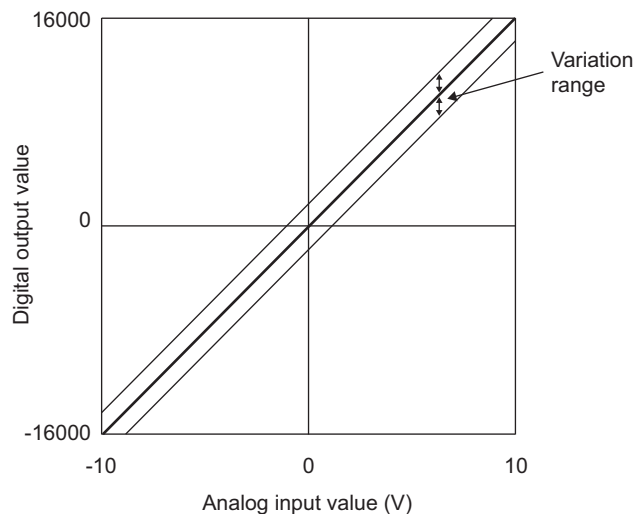

Figure 3.3 Accuracy in -10 to 10V range

## 3.3.4 Conversion speed

The conversion speed of the AJ65SBT2B-64AD is 200 $\mu$ s/channel. The conversion speed is the time for taking in an analog input value and converting it to a digital output value. However, the CC-Link system requires additional time for data link processing. Therefore, the time of the cycle to store the value in CH□ Digital output value (RWrn to RWrn+3) is calculated by the following formula.

[Formula\*1]

$$\text{Data link processing time} = \text{SM} + \text{LS} \times 1 + \text{Remote device station processing time} \quad [\text{ms}]$$

**SM: Scan time of master station sequence program**  
**LS: Link scan time**  
**Remote device station processing time: 1ms**

\* 1 This formula is applicable for the data link processing time (normal value) when the master module is the QJ61BT11N and it is in asynchronous mode.

For details on the data link processing time, refer to the user's manual of the master module used.

## 3.4 Functions

This section describes the functions of the AJ65SBT2B-64AD.

### 3.4.1 Function list

This section lists the functions of the AJ65SBT2B-64AD.

**Table 3.7 Function list of the AJ65SBT2B-64AD**

Item	Description	Reference
A/D conversion enable/disable function	The A/D conversion can be enabled or disabled for each channel using this function. By setting A/D conversion disabled for unnecessary channels, the conversion cycle shortens.	Section 3.4.2
Sampling processing/average processing specification	The sampling processing or average processing (count average/time average/moving average) can be specified using this function.	Section 3.4.3
Input range setting function	The analog input range to be used can be set from factory default ranges (4 to 20mA, 0 to 20mA, 1 to 5V, 0 to 5V, -10 to 10V) and user ranges (user range settings) using this function. Use this function to change the input conversion characteristics.	Section 3.4.4
Offset/gain setting	The digital output value error can be correct using this function.	Section 4.8
Transmission speed auto-tracking function	When the AJ65SBT2B-64AD is powered on, the transmission speed is set automatically according to the setting in the master module.	-

## 3.4.2 A/D conversion enable/disable function

The A/D conversion can be enabled or disabled for each channel using this function. By setting A/D conversion disabled for unnecessary channels, the conversion cycle shortens.

The conversion cycle is calculated with "Conversion speed (200μs) × Number of conversion-enabled channels".

By default, the A/D conversion is disabled for all channels.

### (1) Setting method

Set the A/D conversion enable/disable function in CH□ A/D conversion enable/disable setting (RYn0 to RYn3).

After the setting is completed, turn Initial data setting request flag (RY(n+1)9) from off to on to reflect the setting contents.

Table 3.8 A/D conversion enable/disable setting

Setting item	Description
CH□ A/D conversion enable/disable setting (RYn0 to RYn3)	ON: A/D conversion enabled
	OFF: A/D conversion disabled

### (2) Process after the change of A/D conversion enable/disable setting

#### (a) A/D conversion disabled → A/D conversion enabled

- The conversion starts in the enabled channel.
- When the first A/D conversion is completed after the A/D conversion enable setting, the digital output value in the corresponding channel is stored in the CH□ Digital output value (RWrn to RWrn+3). After the digital output value is stored, CH□ A/D conversion completion flag (RXn0 to RXn3) is turned on in the corresponding channel.

#### (b) A/D conversion enabled → A/D conversion disabled

- The conversion stops in the disabled channel. The digital output value stored in CH□ Digital output value (RWrn to RWrn+3) in the corresponding channel is cleared to "0".
- CH□ A/D conversion completion flag (RXn0 to RXn3) in the corresponding channel is turned off.

### 3.4.3 Sampling processing/average processing specification

The conversion method can be specified from sampling processing/count average/time average/moving average for each channel in AJ65SBT2B-64AD.

Specify the conversion method with the lower 8 bit in the CH□ Average processing setting (RWwm to RWwm+3). Then, in the specified conversion method, set the count average/time average/moving average with the upper 8 bit.

After the setting is completed, turn Initial data setting request flag (RY(n+1)9) from off to on to reflect the setting contents.

The default average processing is the sampling processing (0000<sub>H</sub>).

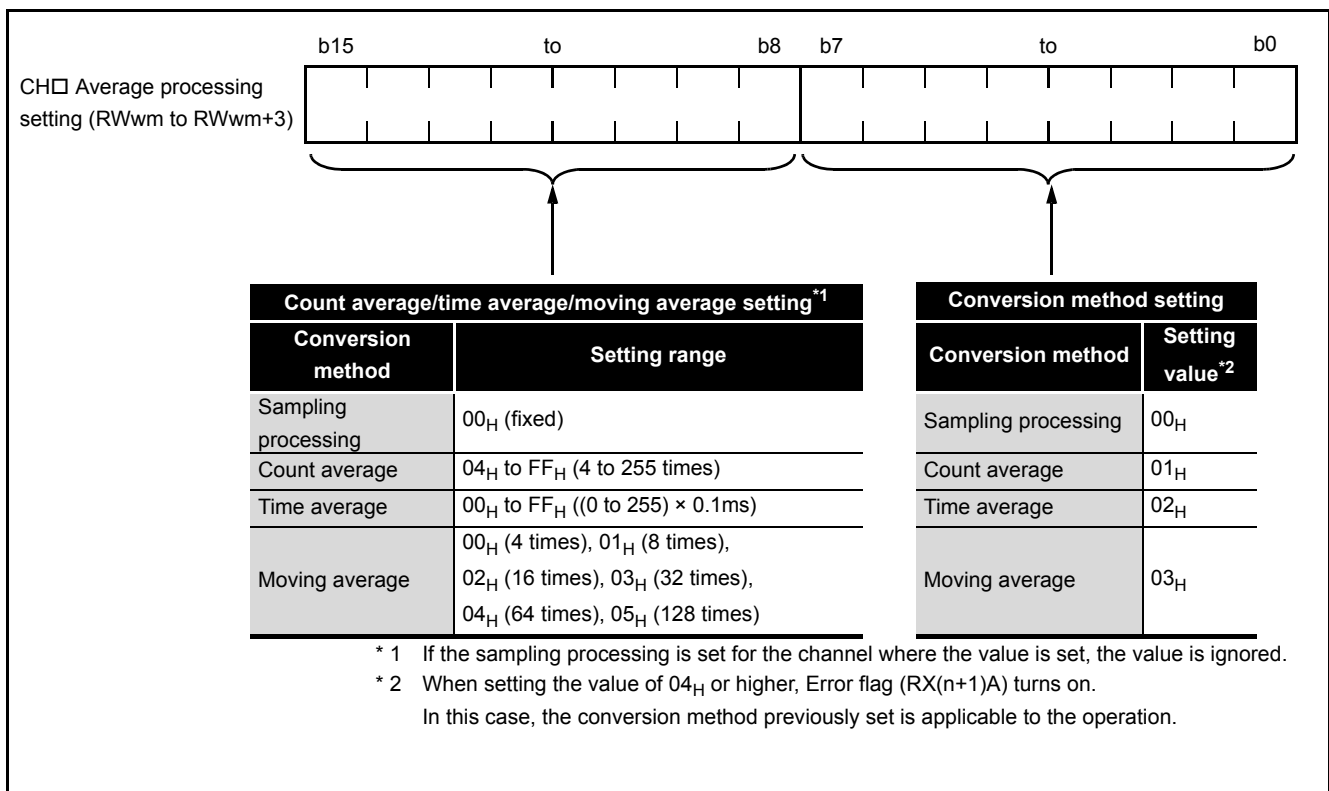

Figure 3.4 Sampling processing/average processing specification



(1) Sampling processing

A/D conversion is performed on analog input values sequentially at every cycle, and the digital output values are stored in a remote register.

**POINT**

The conversion cycle is calculated with "Conversion speed (200μs) × Number of conversion-enabled channels". The A/D conversion can be enabled or disabled for each channel. By disabling the A/D conversion at unused channels, the conversion cycle shortens.

(Example 1) Conversion cycle when A/D conversion is enabled at all channels  
 $200\mu\text{s} \times 4 \text{ channels} = 800\mu\text{s}$

(Example 2) Conversion cycle when A/D conversion is enabled at only one channel  
 $200\mu\text{s} \times 1 \text{ channel} = 200\mu\text{s}$

(2) Count average processing

The A/D conversion is performed the number of times specified. The total of the converted values except the maximum value and the minimum value is averaged. Then, the average value is stored in the remote register.

The number of conversion-enabled channels determines the time taken to store the average value acquired by the count average processing in the remote register

$$\text{Processing time} = \text{Preset count} \times \left( \text{Number of conversion-enabled channels} \times \text{Conversion speed} \right)$$

The count (for averaging) can be configured within the range of 04<sub>H</sub> to FF<sub>H</sub> (4 to 255 times).

(Example) The processing time with the following settings

- Number of conversion-enabled channels: 4 channels
- Count (for averaging): 5 times (05<sub>H</sub>)
- Conversion speed: 0.2ms (200μs)

$$5 \times (4 \times 0.2) = 4 \text{ (ms)} \rightarrow \text{The average value is output every 4ms.}$$

**POINT**

The count average processing needs the total of at least two values except the maximum and minimum. Therefore, the set number of times should be four or more. When setting the count (for averaging) with less than four times, no error occurs. Instead, the processing is performed as sampling processing (1 time).

## (3) Time average processing

The A/D conversion is performed for the duration of the set time. The total of the converted values except a maximum value and a minimum value is averaged. Then, the average value is stored in the remote register.

The number of conversion-enabled channels determines the processing times within the setting time.

$$\text{Number of processing times} = \frac{\text{Setting time}}{\text{Number of conversion-enabled channels} \times 200\mu\text{s}}$$

The setting time for averaging can be configured within the range of 00<sub>H</sub> to FF<sub>H</sub> ((0 to 255) × 0.1ms).

The setting time should be configured by 0.1ms. (Set 50<sub>H</sub> (80) for the setting time of 8.0ms.)

(Example) The number of processing with the following settings

- Number of conversion-enabled channels: 4 channels
- Setting time: 3.2ms (20<sub>H</sub>)
- Conversion speed: 0.2ms (200μs)

$$\frac{3.2}{4 \times 0.2} = 4 \text{ (times)}$$

---

**☒ POINT**

For the time average processing, "4 times (minimum processing times) × Conversion speed × Number of channels used" is valid as the minimum value for setting. If the number of processing is less than four times by setting time, no error occurs. Instead, the processing is performed as sampling processing.

---

(4) Moving average processing

The module averages digital output values of the set number of times that are taken in for each sampling cycle. Then the module stores the averaged value in the remote register. The latest digital output value can be obtained since averaging processing is performed every sampling cycle.

Select the count (for averaging) from 4 (00<sub>H</sub>), 8 (01<sub>H</sub>), 16 (02<sub>H</sub>), 32 (03<sub>H</sub>), 64 (04<sub>H</sub>), and 128 (05<sub>H</sub>) times.

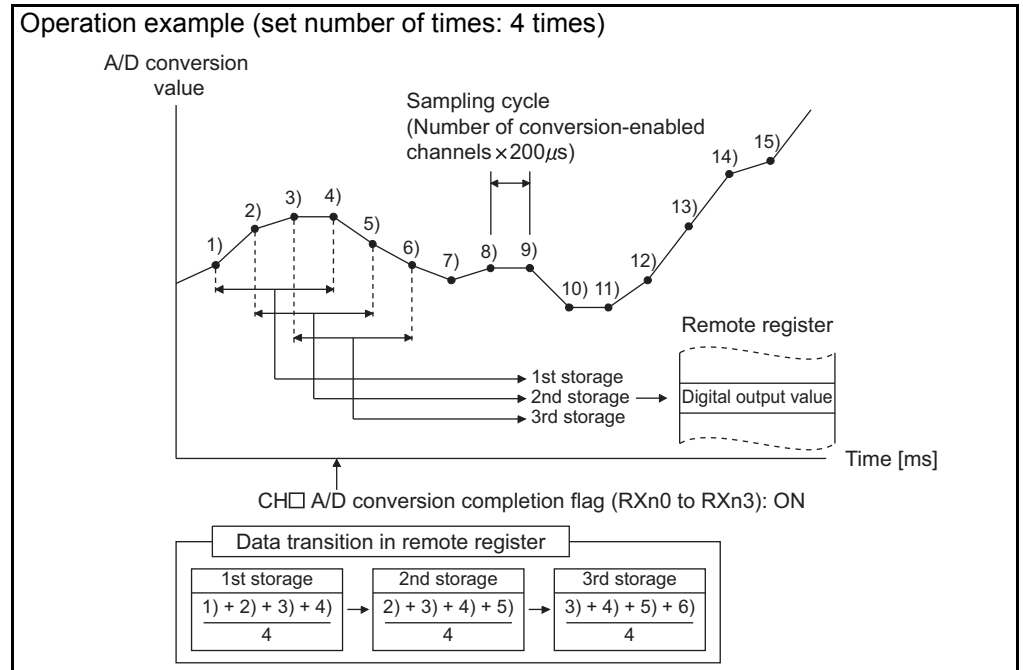

**POINT**

When setting the count (for averaging) of the moving average processing to 06<sub>H</sub> or higher, Error flag (RX(n+1)A) turns on and the RUN LED flashes at intervals of 0.5s.

### 3.4.4 Input range setting function

The analog input range to be used in each channel can be set using this function.

#### (1) Setting method

Set an analog input range by combining ON/OFF of three remote output signals for each channel. (For CH1, set the range within CH1 Input range setting (0th bit) (RYn4) to CH1 Input range setting (2nd bit) (RYn6).)

For the combinations of settings, refer to Table 3.9.

After the setting is completed, turn Initial data setting request flag (RY(n+1)9) from off to on to reflect the setting contents.

The default analog input range is -10 to 10V.

Table 3.9 Analog input range setting

Analog input range	CH□ Input range setting (RYn4 to RYnF)											
	CH4			CH3			CH2			CH1		
	RYnF	RYnE	RYnD	RYnC	RYnB	RYnA	RYn9	RYn8	RYn7	RYn6	RYn5	RYn4
-10 to 10V	OFF	OFF	OFF	OFF	OFF	OFF	OFF	OFF	OFF	OFF	OFF	OFF
0 to 5V	OFF	OFF	ON	OFF	OFF	ON	OFF	OFF	ON	OFF	OFF	ON
1 to 5V	OFF	ON	OFF	OFF	ON	OFF	OFF	ON	OFF	OFF	ON	OFF
0 to 20mA	OFF	ON	ON	OFF	ON	ON	OFF	ON	ON	OFF	ON	ON
4 to 20mA	ON	OFF	OFF	ON	OFF	OFF	ON	OFF	OFF	ON	OFF	OFF
User range setting 1 (-10 to 10V)	ON	OFF	ON	ON	OFF	ON	ON	OFF	ON	ON	OFF	ON
User range setting 2 (-5 to 5V) or (Current)	ON	ON	OFF	ON	ON	OFF	ON	ON	OFF	ON	ON	OFF

#### (2) Error check method

If all signals in CH□ Input range setting (RYn4 to RYnF) are ON, Error flag (RX(n+1)A) turns on, which indicates an error.

When an error occurs, the RUN LED flashes at intervals of 0.1s. Set the analog input range again.

## 3.5 Remote I/O Signals

This section describes the assignments of remote I/O signals and their functions.

### 3.5.1 List of remote I/O signals

Remote input (RX) indicates the input signal from the AJ65SBT2B-64AD to a master module. Remote output (RY) indicates the output signal from a master module to the AJ65SBT2B-64AD.

The AJ65SBT2B-64AD uses 32 points of Remote input (RX) and 32 points of Remote output (RY) in communication with a master station.

Table 3.10 List of remote I/O signals

Signal direction: AJ65SBT2B-64AD → Master module		Signal direction: Master module → AJ65SBT2B-64AD	
Remote input (RX)	Name	Remote output (RY)	Name
RXn0	CH1 A/D conversion completion flag	RYn0	CH1 A/D conversion enable/disable setting
RXn1	CH2 A/D conversion completion flag	RYn1	CH2 A/D conversion enable/disable setting
RXn2	CH3 A/D conversion completion flag	RYn2	CH3 A/D conversion enable/disable setting
RXn3	CH4 A/D conversion completion flag	RYn3	CH4 A/D conversion enable/disable setting
RXn4	Reserved	RYn4	CH1 Input range setting (0th bit)
RXn5		RYn5	CH1 Input range setting (1st bit)
RXn6		RYn6	CH1 Input range setting (2nd bit)
RXn7		RYn7	CH2 Input range setting (0th bit)
RXn8		RYn8	CH2 Input range setting (1st bit)
RXn9		RYn9	CH2 Input range setting (2nd bit)
RXnA	Hardware error flag	RYnA	CH3 Input range setting (0th bit)
RXnB	User range read error flag	RYnB	CH3 Input range setting (1st bit)
RXnC	Flash memory write error flag	RYnC	CH3 Input range setting (2nd bit)
RXnD	Number of offset/gain settings excess flag	RYnD	CH4 Input range setting (0th bit)
RXnE	Reserved	RYnE	CH4 Input range setting (1st bit)
RXnF	Test mode flag	RYnF	CH4 Input range setting (2nd bit)
RX(n+1)0	Reserved	RY(n+1)0	Reserved
RX(n+1)1		RY(n+1)1	
RX(n+1)2		RY(n+1)2	
RX(n+1)3		RY(n+1)3	
RX(n+1)4		RY(n+1)4	
RX(n+1)5		RY(n+1)5	
RX(n+1)6		RY(n+1)6	
RX(n+1)7		RY(n+1)7	
RX(n+1)8	Initial data processing request flag	RY(n+1)8	Initial data processing completion flag
RX(n+1)9	Initial data setting completion flag	RY(n+1)9	Initial data setting request flag
RX(n+1)A	Error flag	RY(n+1)A	Error reset request flag
RX(n+1)B	Remote ready	RY(n+1)B	Reserved
RX(n+1)C	Reserved	RY(n+1)C	
RX(n+1)D		RY(n+1)D	
RX(n+1)E		RY(n+1)E	
RX(n+1)F		RY(n+1)F	

n: The address assigned to the master station by station number setting

#### POINT

The system uses the Reserved devices described in Table 3.10. These devices are not available for users. If they are turned on or off by the user, the function as the AJ65SBT2B-64AD is not guaranteed.

### 3.5.2 Details on each remote I/O signal

---

This section describes the function of each remote I/O signal of the AJ65SBT2B-64AD.

(1) CH□ A/D conversion completion flag (RXn0 to RXn3)

CH□ A/D conversion completion flag (RXn0 to RXn3) in the corresponding channel turns on under the following sequential conditions:

- The power is turned on.
- Initial data setting request flag (RY(n+1)9) is turned from off to on.
- As the first A/D conversion is completed in the channel where A/D conversion is enabled, the digital output value is stored in the remote register.

For an average processing, the flag turns on when the first average processing is completed and the digital output value is stored in the remote register.

(2) Hardware error flag (RXnA)

This flag turns on when the AJ65SBT2B-64AD detects a hardware failure. Error reset request flag (RY(n+1)A) cannot reset (turn off) this flag.

(3) User range read error flag (RXnB)

This flag turns on when the user range setting 1 or 2 is configured in the input range setting and each user range setting value read from a flash memory has an error.

This flag can be reset with Error reset request flag (RY(n+1)A). Turn on Error reset request flag (RY(n+1)A) and perform the offset/gain setting for all channels that use the user range setting.

(4) Flash memory write error flag (RXnC)

This flag turns on if the write to the flash memory is failed when configuring the offset/gain setting.

Error reset request flag (RY(n+1)A) cannot reset (turn off) this flag since it indicates the failure of the AJ65SBT2B-64AD (hardware failure).

(5) Number of offset/gain settings excess flag (RXnD)

This flag turns on when the number of offset/gain setting times exceeds the maximum of the guaranteed value (10,000 times).

Error reset request flag (RY(n+1)A) can reset (turn off) this flag. However, after this flag turns on, the setting value acquired by the offset/gain setting is not guaranteed.

(6) Test mode flag (RXnF)

This flag turns on when the module moves onto test mode for the offset/gain setting.

This flag turns off when the module moves from test mode to normal mode.

Before performing the offset/gain setting, confirm that this flag is ON.

(7) Initial data processing request flag (RX(n+1)8)

After power-on, this flag turns ON for the AJ65SBT2B-64AD to request an initial data. When Initial data processing completion flag (RY(n+1)8) is turned on, this flag turns off.

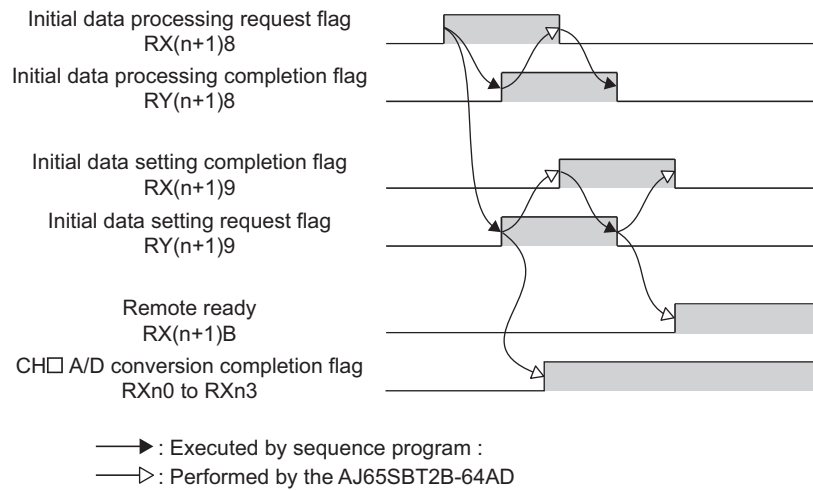

Figure 3.5 Operation at initial data setting

(8) Initial data setting completion flag (RX(n+1)9)

If Initial data setting request flag (RY(n+1)9) is turned on, this flag turns on after the initial data setting is completed.

If Initial data setting request flag (RY(n+1)9) is turned off when the initial data setting is completed, this flag also turns off.

For the timing of turning on/off the remote I/O signal for the initial data setting, refer to Figure 3.5.

## (9) Error flag (RX(n+1)A)

This flag turns on in the following conditions.

- The average processing setting value is outside the range.
- An analog input range setting is outside the range.
- Hardware error flag (RXnA) is ON.
- User range read error flag (RXnB) is ON.
- Flash memory write error flag (RXnC) is ON.

This flag does not turn on when a watchdog timer error occurs. (At this time, the RUN LED turns off.)

When Error reset request flag (RY(n+1)A) is turned on, this flag turns off. The following flags are reset (turned off) by turning on Error reset request flag (RY(n+1)A). However, an error cannot be resolved. For corrective actions on each error, refer to CHAPTER 6 .

- User range read error flag (RXnB)
- Number of offset/gain settings excess flag (RXnD)

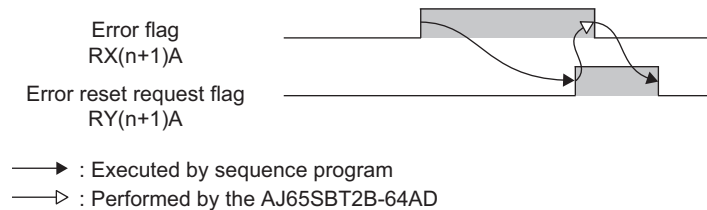

**Figure 3.6 Operation at error occurrence and reset**

## (10) Remote ready (RX(n+1)B)

After power-on, when the test mode ends or Initial data setting completion flag (RX(n+1)9) turns off after the initial data setting is completed, this flag turns ON. This flag is used for an interlock to read/write data from/to the master module.

## (11) CH□ A/D conversion enable/disable setting (RYn0 to RYn3)

The A/D conversion enable/disable is set for each channel.

By setting A/D conversion disabled for unnecessary channels, the conversion cycle shortens.

ON: A/D conversion enabled

OFF: A/D conversion disabled

For A/D conversion enable/disable setting, refer to Section 3.4.2.

## (12) CH□ Input range setting (RYn4 to RYnF)

The analog input range is set for each channel.

For the analog input range setting contents, refer to Section 3.4.4.



## (13) Initial data processing completion flag (RY(n+1)8)

After power-on, or when requesting the initial data processing after the test mode operation, initial data processing is started. After completion of the processing, this flag is turned on.

For the timing of turning on/off the remote I/O signal for the initial data setting, refer to Figure 3.5.

## (14) Initial data setting request flag (RY(n+1)9)

When performing or changing the initial data setting, this flag is turned on.

The following setting contents become valid by turning this flag from off to on.

- CH□ A/D conversion enable/disable setting (RYn0 to RYn3)
- CH□ Input range setting (RYn4 to RYnF)
- CH□ Average processing setting (RWwm to RWwm+3)

For the timing of turning on/off the remote I/O signal for the initial data setting, refer to Figure 3.5.

## (15) Error reset request flag (RY(n+1)A)

The following flags are reset (turned off) by turning on this flag.

- User range read error flag (RXnB)
- Number of offset/gain settings excess flag (RXnD)
- Error flag (RX(n+1)A)

When Hardware error flag (RXnA) or Flash memory write error flag (RXnC) is ON, these flags cannot be reset (turned off).

## 3.6 Remote Register

The AJ65SBT2B-64AD has a remote register for data communication with the master module.

This section describes the assignment of the remote register.

### 3.6.1 List of remote register assignments

Table 3.11 shows the remote register assignments.

Table 3.11 Remote register assignments

Communication direction	Address	Description	Default value
Master → Remote	RWwm	CH1 Average processing setting	0
	RWwm+1	CH2 Average processing setting	0
	RWwm+2	CH3 Average processing setting	0
	RWwm+3	CH4 Average processing setting	0
Remote → Master	RWrn	CH1 Digital output value	0
	RWrn+1	CH2 Digital output value	0
	RWrn+2	CH3 Digital output value	0
	RWrn+3	CH4 Digital output value	0

m, n: The address assigned to the master station by a station number setting

### 3.6.2 Details of remote register

(1) CH□ Average processing setting (RWwm to RWwm+3)

Specify a conversion method from the sampling processing/count average/time average/moving average in the lower 8 bit for each channel. Set the count (for averaging) or time (for averaging) in the upper 8 bit within the setting range of the specified conversion method.

For details on the specifying method, refer to Section 3.4.3.

(2) CH□ Digital output value (RWrn to RWrn+3)

This register stores the digital output values after A/D conversion for each channel. The digital output values are stored with 16-bit signed binary.

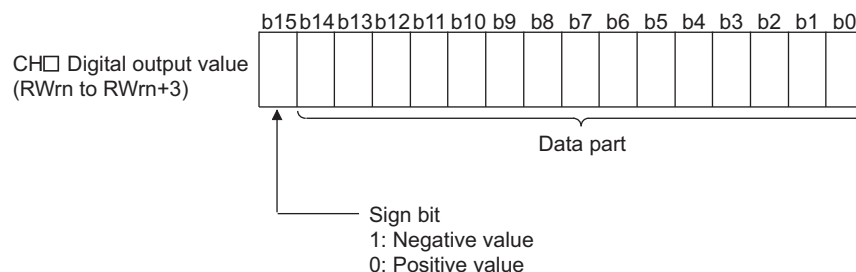

Figure 3.7 CH□ Digital output value (RWrn to RWrn+3)

## CHAPTER 4 SETTINGS AND THE PROCEDURE BEFORE OPERATION

### 4.1 The Procedure Before Operation

This section describes the procedure before operation of the AJ65SBT2B-64AD.

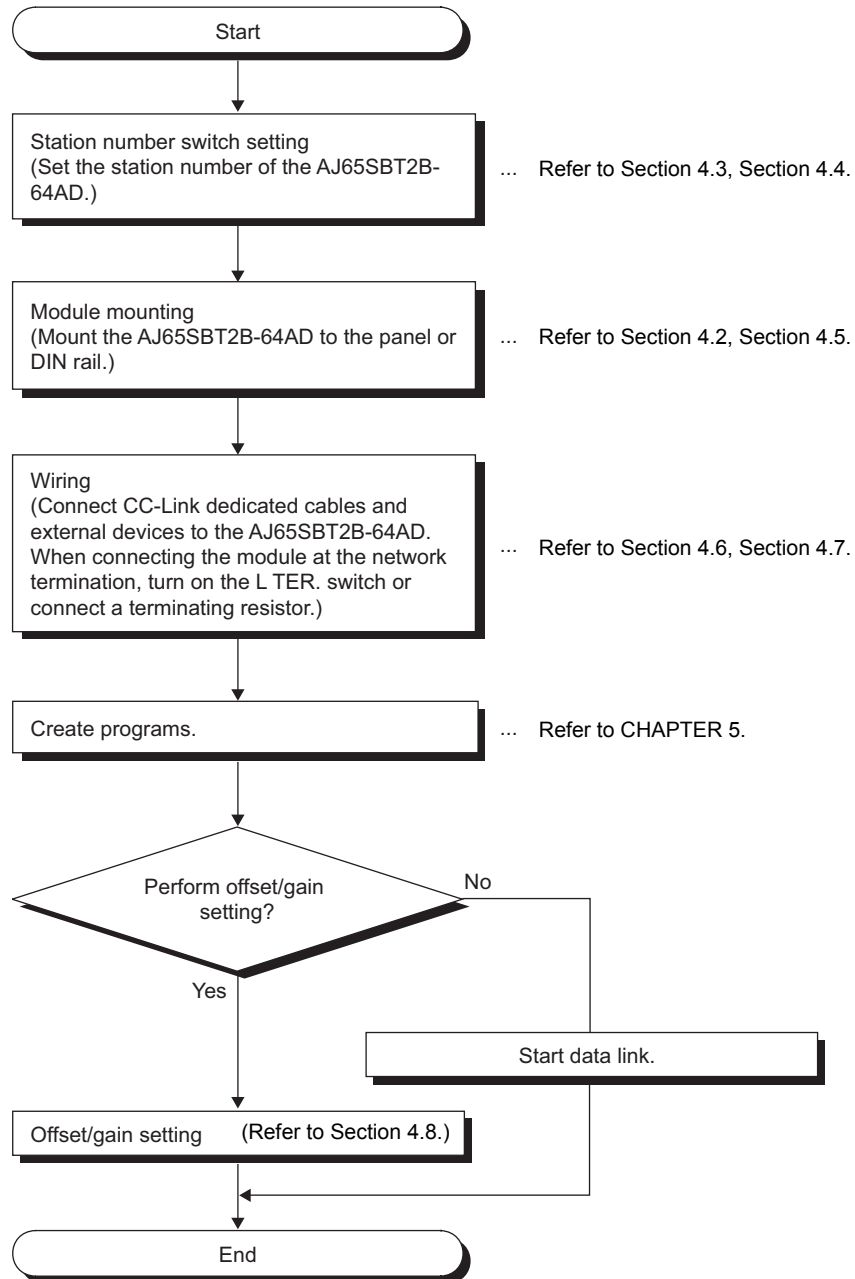

Figure 4.1 The procedure before operation

## 4.2 Handling Precautions

---

This section describes precautions for handling the AJ65SBT2B-64AD.

### **WARNING**

- Do not touch any terminal while power is on. Doing so will cause electric shock or malfunction.

### **CAUTION**

- Prevent foreign matter such as dust or wire chips from entering the module.  
Such foreign matter can cause a fire, failure, or malfunction.
- Do not disassemble or modify the module.  
Doing so may cause failure, malfunction, injury, or a fire.
- Do not directly touch any conductive part of the module.  
Doing so can cause malfunction or failure of the module.
- Do not drop or apply strong shock to the module. Doing so may damage the module.
- Use the module in an environment that meets the general specifications in this manual.  
Failure to do so may result in electric shock, fire, malfunction, or damage to or deterioration of the product.
- When disposing of this product, treat it as industrial waste.
- For protection of the switches, do not remove the cushioning material before installation.
- Securely fix the module with a DIN rail or mounting screws. Tighten the screws within the specified torque range.  
Undertightening can cause drop of the screw, short circuit or malfunction.  
Overtightening can damage the screw and/or module, resulting in drop, short circuit, or malfunction.
- Shut off the external power supply for the system in all phases before installing or removing a module to/from a control panel. Failure to do so may cause the module to fail or malfunction.
- Before handling the module, touch a grounded metal object to discharge the static electricity from the human body. Failure to do so may cause the module to fail or malfunction.

- (1) Tighten the module mounting screws and terminal block screws within the tightening torque range specified in Table 4.1.

Table 4.1 Tightening torque range

Screw	Tightening torque range
Module mounting screw (M4)	0.78 to 1.08N·m
Terminal block terminal screw (M3)	0.59 to 0.88N·m
Terminal block mounting screw (M3.5)	0.68 to 0.98N·m

- (2) When using a DIN rail, pay attention to the following:
- (a) Applicable DIN rail (compliant with IEC 60715)
    - TH35-7.5Fe
    - TH35-7.5Al
  - (b) Installation screw intervals
    - Tighten the screws at intervals of 200mm or less.
- (3) When mounting the AJ65SBT2B-64AD to a DIN rail, push in the DIN rail hook until it clicks.

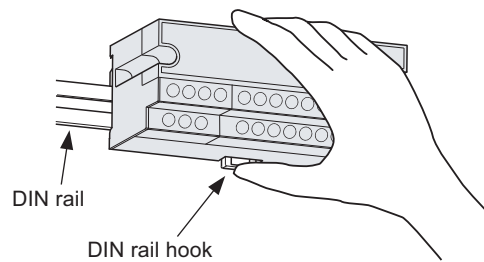

Figure 4.2 Mounting a module to a DIN rail

- (4) For names, specifications, and manufacturers of applicable cables, refer to the user's manual for the master module used.

## 4.3 Part Names

This section describes the part names of the AJ65SBT2B-64AD.

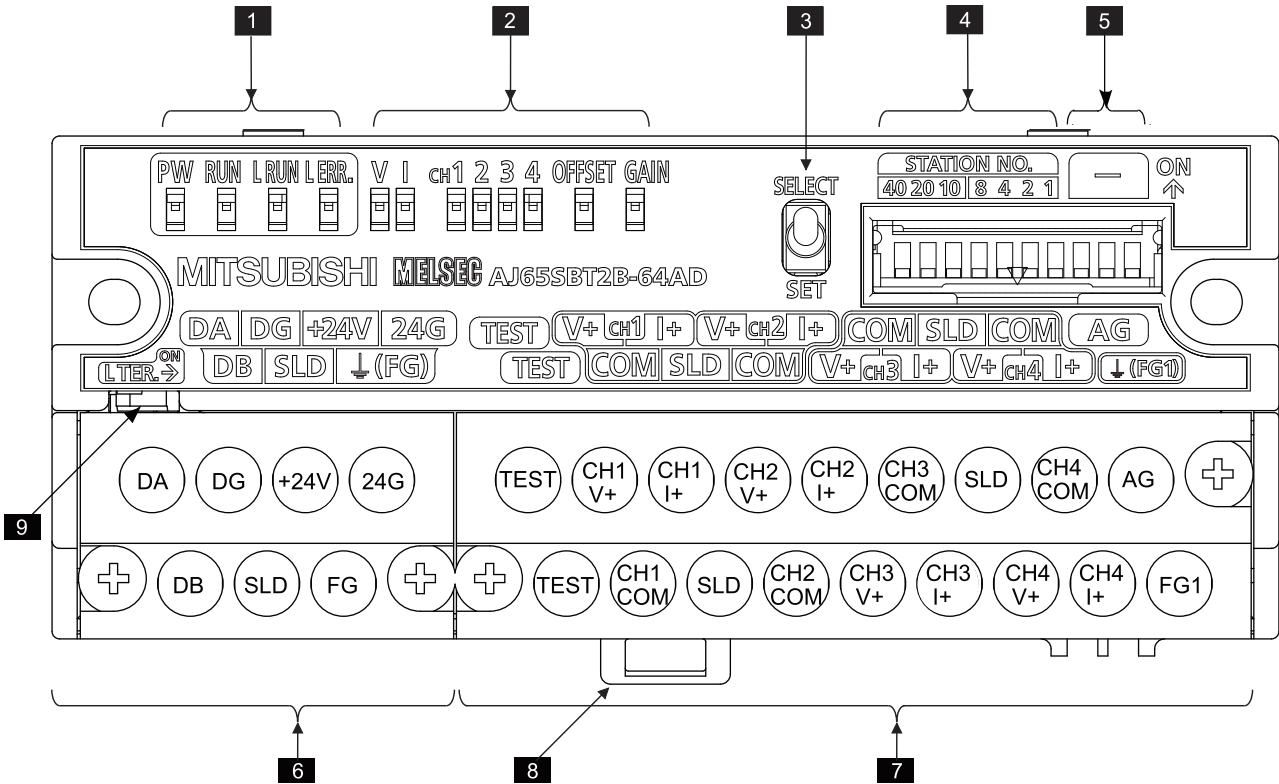

Figure 4.3 Appearance of the AJ65SBT2B-64AD

Table 4.2 Part names

No.	Name	Description					
1	Operation status indicator LED	PW LED	On: Power supply on Off: Power supply off				
		RUN LED	Normal mode	On: Normal operation Flashing: 0.1s intervals: Any of the following occurs: An analog value outside the analog input range is input. A user range read error occurs. Hardware failure occurs. 0.5s intervals: An out of averaging processing setting range error occurs. Off: The 24VDC power supply is shut off or a watchdog timer error occurs.			
			Test mode	On: The SELECT/SET switch is in the SET position. Flashing: Any of the following occurs: The offset/gain setting has been configured outside the range. A flash memory write error occurs. Hardware failure occurs. Off: The SELECT/SET switch is in the SELECT or center position.			
		L RUN LED	On: Normal communication Off: Communication is cut off. (timeout error)				
		L ERR. LED*1	On: The station number outside the range is set. Flashing regularly: The station number was changed from that at power-on.*2 Flashing irregularly: The module or the CC-Link dedicated cable is affected by noise. The L TER. switch status and the installation status of the terminating resistor are inconsistent. (Refer to Section 6.1 (6).) Off: Normal communication				
2	Offset/gain adjustment LED*3	V LED I LED CHD LED OFFSET LED GAIN LED	LEDs for checking the conditions for which the offset/gain setting is configured in test mode <table border="1"> <tr> <td>Normal mode</td> <td>Always off</td> </tr> <tr> <td>Test mode</td> <td>The on/off status of the LEDs changes whenever the SELECT/SET switch is set to SELECT. (Refer to Section 4.8.)</td> </tr> </table>	Normal mode	Always off	Test mode	The on/off status of the LEDs changes whenever the SELECT/SET switch is set to SELECT. (Refer to Section 4.8.)
Normal mode	Always off						
Test mode	The on/off status of the LEDs changes whenever the SELECT/SET switch is set to SELECT. (Refer to Section 4.8.)						
3	SELECT/SET switch	A switch for configuring the offset/gain setting in test mode					

1 OVERVIEW

2 SYSTEM CONFIGURATION

3 SPECIFICATIONS

4 SETTINGS AND THE PROCEDURE BEFORE OPERATION

5 PROGRAMMING

6 TROUBLESHOOTING

APPENDIX

INDEX

# 4 SETTINGS AND THE PROCEDURE BEFORE OPERATION

MELSEC-A

Table 4.2 Part names

No.	Name	Description																																																																																																														
4	Station number setting switch	<p>With the STATION NO. "10", "20", and "40" switches, the tens place of the station number is set.            With the STATION NO. "1", "2", "4", and "8" switches, the ones place of the station number is set.            These switches are all set to off at default.            A station number must be set within 1 to 64.            Setting any number other than that will result in an error, and the L ERR. LED will turn on.            The same station number cannot be set to several stations.</p> <table border="1"> <thead> <tr> <th rowspan="2">Station number</th> <th colspan="3">Tens place</th> <th colspan="4">Ones place</th> </tr> <tr> <th>40</th> <th>20</th> <th>10</th> <th>8</th> <th>4</th> <th>2</th> <th>1</th> </tr> </thead> <tbody> <tr> <td>1</td> <td>OFF</td> <td>OFF</td> <td>OFF</td> <td>OFF</td> <td>OFF</td> <td>OFF</td> <td>ON</td> </tr> <tr> <td>2</td> <td>OFF</td> <td>OFF</td> <td>OFF</td> <td>OFF</td> <td>OFF</td> <td>ON</td> <td>OFF</td> </tr> <tr> <td>3</td> <td>OFF</td> <td>OFF</td> <td>OFF</td> <td>OFF</td> <td>OFF</td> <td>ON</td> <td>ON</td> </tr> <tr> <td>4</td> <td>OFF</td> <td>OFF</td> <td>OFF</td> <td>OFF</td> <td>ON</td> <td>OFF</td> <td>OFF</td> </tr> <tr> <td>⋮</td> <td>⋮</td> <td>⋮</td> <td>⋮</td> <td>⋮</td> <td>⋮</td> <td>⋮</td> <td>⋮</td> </tr> <tr> <td>10</td> <td>OFF</td> <td>OFF</td> <td>ON</td> <td>OFF</td> <td>OFF</td> <td>OFF</td> <td>OFF</td> </tr> <tr> <td>11</td> <td>OFF</td> <td>OFF</td> <td>ON</td> <td>OFF</td> <td>OFF</td> <td>OFF</td> <td>ON</td> </tr> <tr> <td>⋮</td> <td>⋮</td> <td>⋮</td> <td>⋮</td> <td>⋮</td> <td>⋮</td> <td>⋮</td> <td>⋮</td> </tr> <tr> <td>64</td> <td>ON</td> <td>ON</td> <td>OFF</td> <td>OFF</td> <td>ON</td> <td>OFF</td> <td>OFF</td> </tr> </tbody> </table> <p>(Example) To specify "32" for a station number, set the switches as shown below.</p> <table border="1"> <thead> <tr> <th rowspan="2">Station number</th> <th colspan="3">Tens place</th> <th colspan="4">Ones place</th> </tr> <tr> <th>40</th> <th>20</th> <th>10</th> <th>8</th> <th>4</th> <th>2</th> <th>1</th> </tr> </thead> <tbody> <tr> <td>1</td> <td>OFF</td> <td>ON</td> <td>ON</td> <td>OFF</td> <td>OFF</td> <td>ON</td> <td>OFF</td> </tr> </tbody> </table>	Station number	Tens place			Ones place				40	20	10	8	4	2	1	1	OFF	OFF	OFF	OFF	OFF	OFF	ON	2	OFF	OFF	OFF	OFF	OFF	ON	OFF	3	OFF	OFF	OFF	OFF	OFF	ON	ON	4	OFF	OFF	OFF	OFF	ON	OFF	OFF	⋮	⋮	⋮	⋮	⋮	⋮	⋮	⋮	10	OFF	OFF	ON	OFF	OFF	OFF	OFF	11	OFF	OFF	ON	OFF	OFF	OFF	ON	⋮	⋮	⋮	⋮	⋮	⋮	⋮	⋮	64	ON	ON	OFF	OFF	ON	OFF	OFF	Station number	Tens place			Ones place				40	20	10	8	4	2	1	1	OFF	ON	ON	OFF	OFF	ON	OFF
Station number	Tens place			Ones place																																																																																																												
	40	20	10	8	4	2	1																																																																																																									
1	OFF	OFF	OFF	OFF	OFF	OFF	ON																																																																																																									
2	OFF	OFF	OFF	OFF	OFF	ON	OFF																																																																																																									
3	OFF	OFF	OFF	OFF	OFF	ON	ON																																																																																																									
4	OFF	OFF	OFF	OFF	ON	OFF	OFF																																																																																																									
⋮	⋮	⋮	⋮	⋮	⋮	⋮	⋮																																																																																																									
10	OFF	OFF	ON	OFF	OFF	OFF	OFF																																																																																																									
11	OFF	OFF	ON	OFF	OFF	OFF	ON																																																																																																									
⋮	⋮	⋮	⋮	⋮	⋮	⋮	⋮																																																																																																									
64	ON	ON	OFF	OFF	ON	OFF	OFF																																																																																																									
Station number	Tens place			Ones place																																																																																																												
	40	20	10	8	4	2	1																																																																																																									
1	OFF	ON	ON	OFF	OFF	ON	OFF																																																																																																									
5	Use prohibited	All switches must be set to off.																																																																																																														
6	Terminal block for transmission and module power supply lines	<p>A terminal block for transmission and module power supply lines</p> <table border="1"> <thead> <tr> <th>Terminal</th> <th>Description</th> </tr> </thead> <tbody> <tr> <td>DA</td> <td rowspan="4">Terminals for connecting CC-Link dedicated cables</td> </tr> <tr> <td>DB</td> </tr> <tr> <td>DG</td> </tr> <tr> <td>SLD</td> </tr> <tr> <td>FG</td> <td>A terminal for grounding to the protective ground conductor</td> </tr> <tr> <td>+24V</td> <td rowspan="2">Terminals for connecting an external power supply</td> </tr> <tr> <td>24G</td> </tr> </tbody> </table>	Terminal	Description	DA	Terminals for connecting CC-Link dedicated cables	DB	DG	SLD	FG	A terminal for grounding to the protective ground conductor	+24V	Terminals for connecting an external power supply	24G																																																																																																		
Terminal	Description																																																																																																															
DA	Terminals for connecting CC-Link dedicated cables																																																																																																															
DB																																																																																																																
DG																																																																																																																
SLD																																																																																																																
FG	A terminal for grounding to the protective ground conductor																																																																																																															
+24V	Terminals for connecting an external power supply																																																																																																															
24G																																																																																																																
7	Terminal block for analog input signal	<p>A terminal block for connecting input signals</p> <table border="1"> <thead> <tr> <th>Terminal</th> <th>Description</th> </tr> </thead> <tbody> <tr> <td>CH□V+</td> <td rowspan="4">Terminals for connecting external input signal cables and shielded twisted pair cables</td> </tr> <tr> <td>CH□I+</td> </tr> <tr> <td>CH□COM</td> </tr> <tr> <td>SLD</td> </tr> <tr> <td>TEST</td> <td>A terminal for short in test mode</td> </tr> <tr> <td>AG</td> <td>A ground terminal (spare) (For application, refer to Section 4.7.2.)</td> </tr> <tr> <td>FG1</td> <td>A terminal for grounding to the protective ground conductor</td> </tr> </tbody> </table>	Terminal	Description	CH□V+	Terminals for connecting external input signal cables and shielded twisted pair cables	CH□I+	CH□COM	SLD	TEST	A terminal for short in test mode	AG	A ground terminal (spare) (For application, refer to Section 4.7.2.)	FG1	A terminal for grounding to the protective ground conductor																																																																																																	
Terminal	Description																																																																																																															
CH□V+	Terminals for connecting external input signal cables and shielded twisted pair cables																																																																																																															
CH□I+																																																																																																																
CH□COM																																																																																																																
SLD																																																																																																																
TEST	A terminal for short in test mode																																																																																																															
AG	A ground terminal (spare) (For application, refer to Section 4.7.2.)																																																																																																															
FG1	A terminal for grounding to the protective ground conductor																																																																																																															
8	DIN rail hook	A hook to mount the module to a DIN rail																																																																																																														
9	L TER. (Line Termination) switch	<p>This switch is turned on to enable the built-in terminating resistor.            This switch is used when the AJ65SBT2B-64AD is connected at the network termination.            Its factory default setting is off.</p>																																																																																																														

- \* 1 This LED may turn on for a moment when the power is turned on; though the AJ 65SBT2B-64AD operates normally.
- \* 2 When station number setting switch setting is changed while communication is disconnected, the LED will start flashing irregularly.
- \* 3 When using the user range setting 2 (-5 to 5V) in test mode, set "I" for the offset/gain adjustment LED.



## 4.3.1 Transmission speed auto-tracking function

---

The transmission speed is automatically set depending on the master module setting; therefore, it does not need to be set on the AJ65SBT2B-64AD side.

## 4.4 Station Number Setting

The station number setting of the AJ65SBT2B-64AD determines the buffer memory addresses of the master module in which remote I/O signals and read/write data are to be stored.

For details, refer to the user's manual for the master module used.

## 4.5 Module Mounting Direction

The AJ65SBT2B-64AD can be mounted in 6 directions.

Mounting with DIN rail is also available.

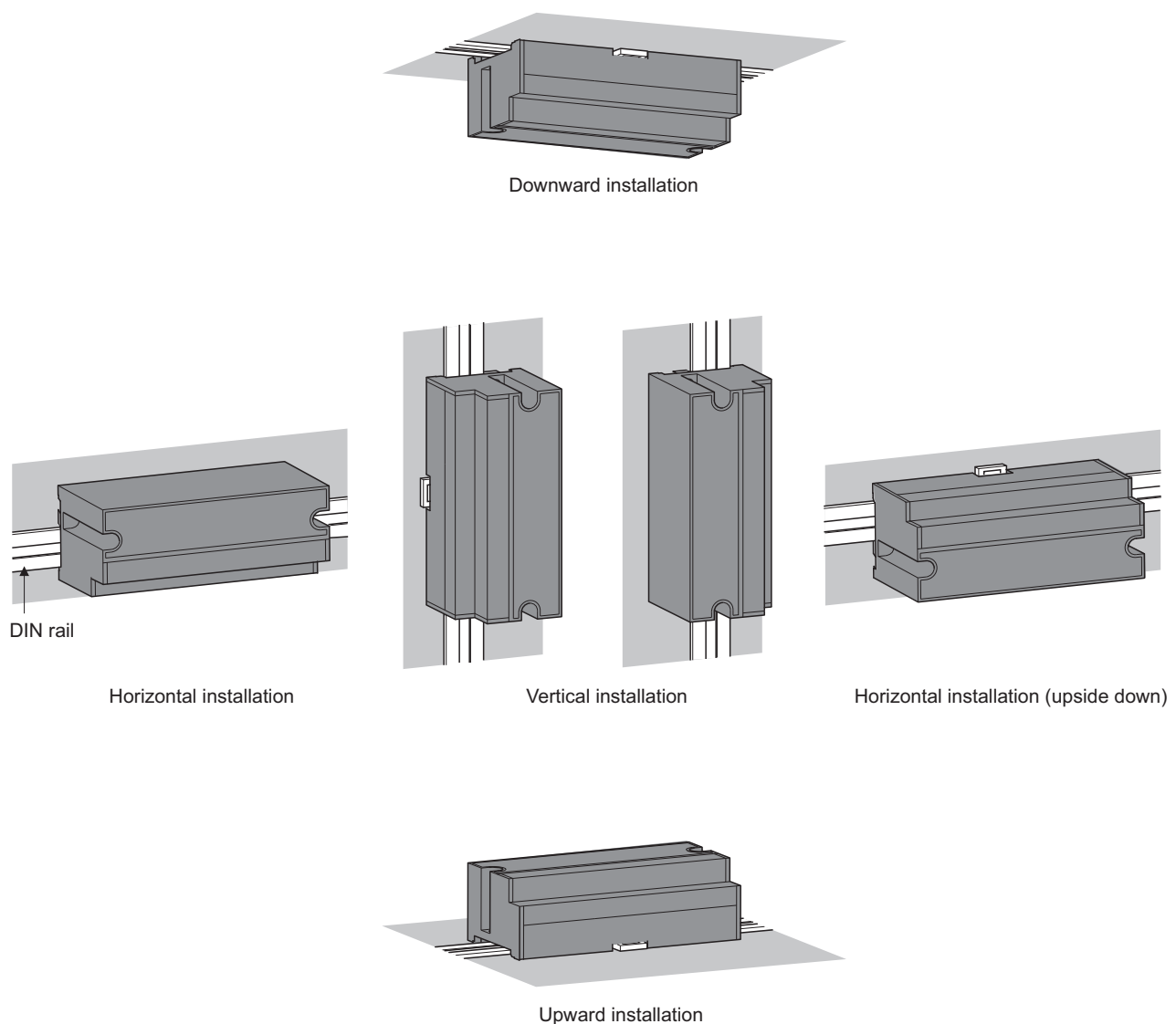

Figure 4.4 Module mounting direction

## 4.6 Wiring of Data Link Cables

This section describes the wiring of CC-Link dedicated cables when connecting the AJ65SBT2B-64AD to a CC-Link system.

### 4.6.1 Wiring precautions

Communication terminal blocks differ between the AJ65SBT-64AD and the AJ65SBT2B-64AD. When replacing the AJ65SBT-64AD with the AJ65SBT2B-64AD, rewire the system using a communication terminal block for the AJ65SBT2B-64AD.

### 4.6.2 Connecting modules using CC-Link dedicated cables

Figure 4.5 shows how to connect the AJ65SBT2B-64AD to a master module and an I/O module using CC-Link dedicated cables.

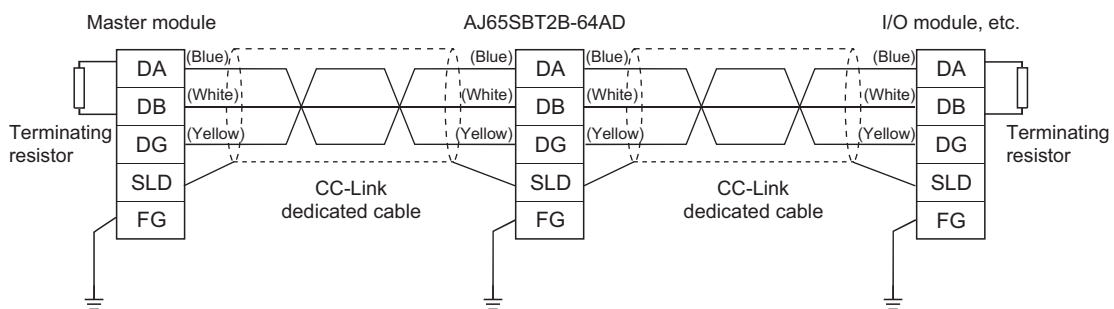

Figure 4.5 Connecting modules using CC-Link dedicated cables

### 4.6.3 Connecting terminating resistors

The AJ65SBT2B-64AD has a built-in terminating resistor of 110Ω. There is no need to connect a terminating resistor externally. When using the AJ65SBT2B-64AD at the network termination, turn on the L TER. switch. The factory default setting of the switch is off.

#### (1) Precautions

- (a) Move the L TER. switch until it clicks.



- (b) The built-in terminating resistor cannot be used in the following cases.

- There is a possibility that the AJ65SBT2B-64AD will be replaced during data link.
- A CC-Link system is configured using CC-Link dedicated cables of 130Ω.

## 4.7 Wiring with External Devices

---

This section explains wiring precautions and wiring with external devices of the AJ65SBT2B-64AD.

### 4.7.1 Wiring precautions

---

To obtain the maximum performance from the functions of the AJ65SBT2B-64AD and improve the system reliability, an external wiring with high durability against noise is required.

Precautions for external wiring are as follows:

- (a) Use separate cables for the AC control circuit and the external input signals of the AJ65SBT2B-64AD to avoid the influence of the AC side surges or induction.
- (b) Do not install cables together with the main circuit lines, high voltage lines, or power cables for equipment other than the programmable controller. Noise, surges, or induction may affect the system.
- (c) Ground the shielded wires or shielded cables at one point on the programmable controller side.  
However, depending on the external noise conditions, it may be better to ground them externally.

## 4.7.2 Wiring with external devices

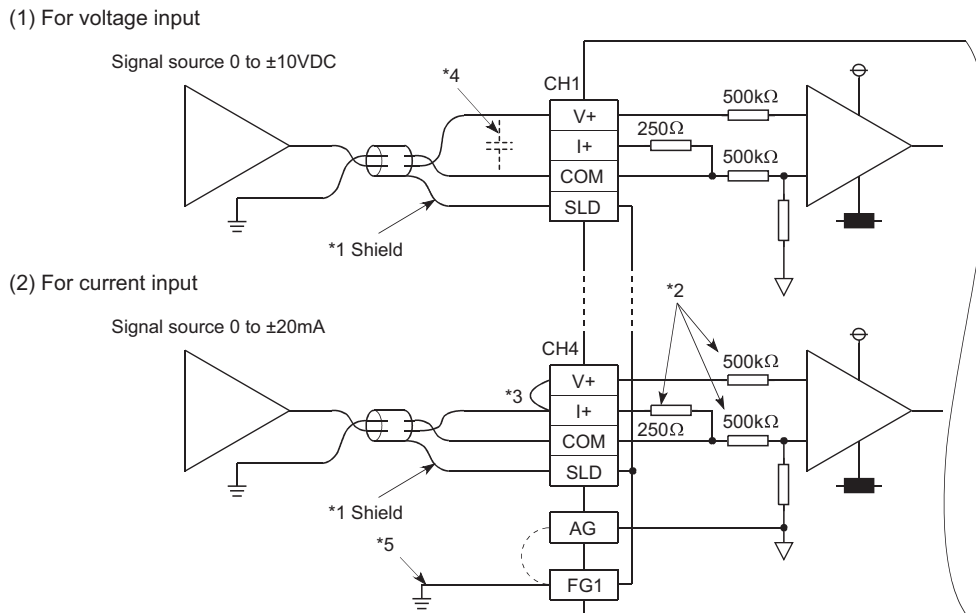

Figure 4.6 Wiring with external devices

- \* 1 Use shielded twisted pair cables.
- \* 2 Input resistors of the AJ65SBT2B-64AD
- \* 3 For the current input, wire between the V+ and I+ terminals.
- \* 4 If there is noise or ripples in the external wiring, connect a 0.1 to 0.47 $\mu\text{F}$  capacitor (25V or higher voltage-resistant product) between the V+ and COM terminals.
- \* 5 Ground the FG1 terminal without fail. If there is much noise, it may be better to ground the AG terminal as well.  
If the grounding status of the AG terminal is changed after the offset/gain values are set, set the values again.

## 4.8 Offset/gain Setting

When correcting errors of digital output values in the user range setting 1 and 2, follow the procedure described in Figure 4.7. On the AJ65SBT2B-64AD, the offset/gain setting can be configured without communication with the master station. In such case, follow the procedure described in Figure 4.8.

### (1) Configuring the offset/gain setting with communication with the master station

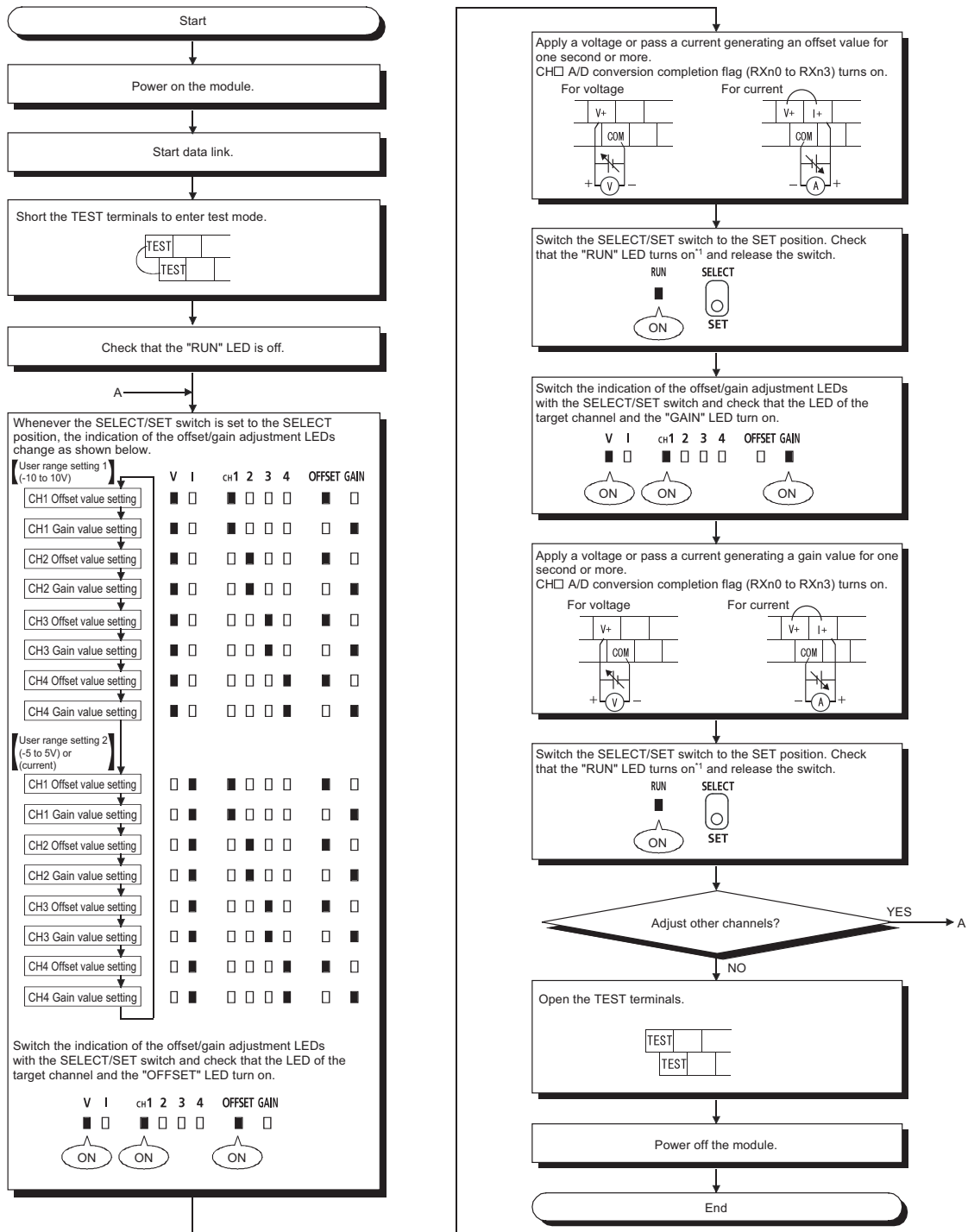

Figure 4.7 Procedure to configure the offset/gain setting with communication with the master station

\* 1 When the RUN LED does not turn on, the possible cause is a failure of the hardware. For details, refer to Section 3.5.2.

## (2) Configuring the offset/gain setting without communication with the master station

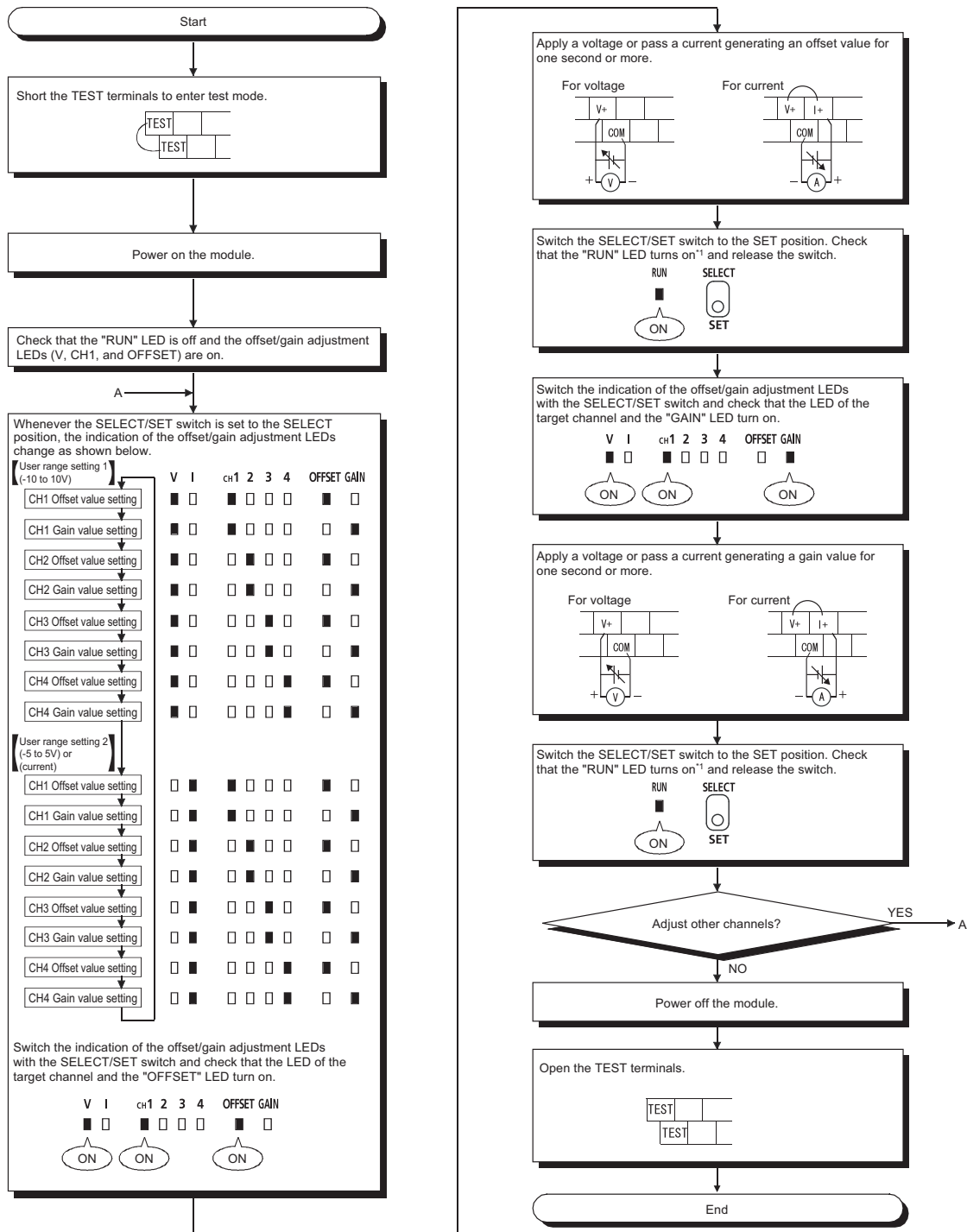

Figure 4.8 Procedure to configure the offset/gain setting without communication with the master station

\* 1 When the RUN LED does not turn on, the possible cause is a failure of the hardware. For details, refer to Section 3.5.2.

---

## ☒ POINT

---

- (1) Configure the offset/gain setting in accordance with the actual use situation.
  - (2) The offset value and gain value are memorized in a flash memory of the AJ65SBT2B-64AD when the SET switch is pressed, and are not deleted even when the power supply is shut off.
  - (3) When the test mode is started by short-circuiting the test terminals, the A/D conversion of the specified channel starts.  
To confirm the AJ65SBT2B-64AD is in test mode, check that Test mode flag (RXnF) is ON. When the offset/gain setting is being configured without communication with the master station, check that the RUN LED is OFF and the offset/gain adjustment LEDs (V, CH1, OFFSET) are ON.
  - (4) To configure the offset/gain setting without communication with the master station, short-circuit the TEST terminals before turning on the power. If the TEST terminals are short-circuited after turning on the power, the AJ65SBT2B-64AD cannot move onto test mode.
  - (5) Configure the offset/gain setting within the range as shown in Section 3.3.1 or Section 3.3.2. If the setting values exceed this range, the resolution or accuracy may be out of the range indicated in the performance specifications. When the RUN LED flashes at intervals of 0.5s after configuring the offset/gain setting, turn on Error reset request flag (RY(n+1)A) to reset an error. Then set values again. When the offset/gain setting is being configured without communication with the master station, an error is reset when the SET switch is pressed after configuring the offset/gain setting again.
  - (6) In the user range setting 2, either current or voltage can be used by changing the wiring. To use the voltage in the user range setting 2, set "I" for the offset/gain adjustment LED.
- 

## 4.9 Maintenance and Inspection

---

The AJ65SBT2B-64AD has no special item to be inspected. However, to maintain the best condition of the system, perform the inspection in accordance with the items described in the user's manual of the CPU module used.



## CHAPTER 5 PROGRAMMING

This chapter describes the programming procedure, basic programs for read and write, and program examples of the AJ65SBT2B-64AD.

When diverting the program examples introduced in this chapter to the actual system, thoroughly verify that there is no control problem with the target system.

For the master module, refer to the user's manual for the master module used.

### 5.1 Programming Procedure

Create a program to perform the A/D conversion in the AJ65SBT2B-64AD, according to the procedure in Figure 5.1.

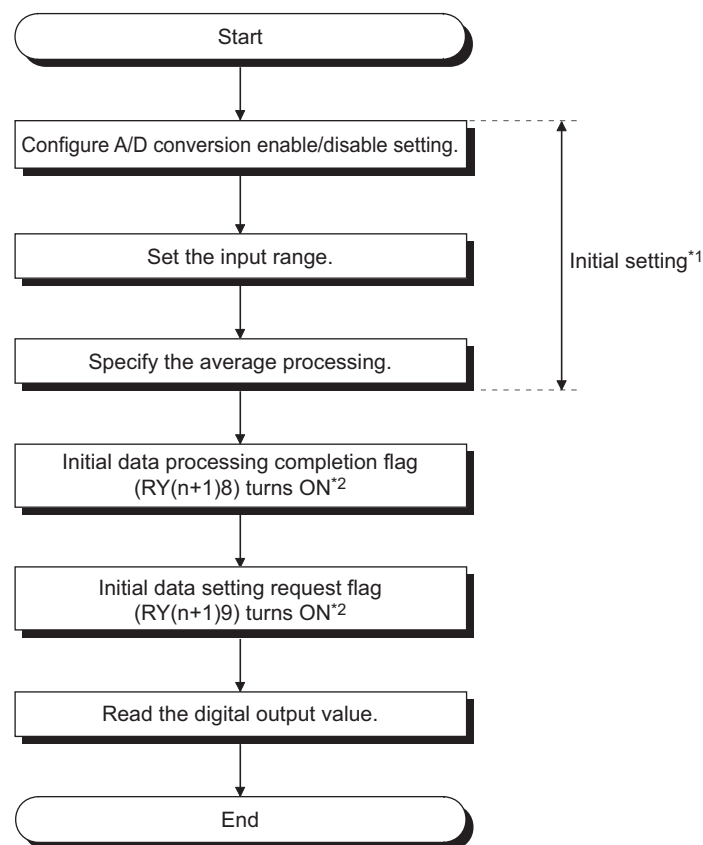

**Figure 5.1 Programming procedure**

\* 1 The initial settings cannot be configured with the "remote device station initialization procedure registration function". Configure it with a sequence program.

\* 2 For the ON/OFF timing of Initial data processing completion flag (RY(n+1)8) and Initial data setting request flag (RY(n+1)9), refer to Section 3.5.2 (7).

## 5.2 Conditions of Program Examples

The program examples in this chapter are created under the following conditions:

(1) Use conditions of the AJ65SBT2B-64AD

- Channels to be used: CH1, CH2
- Analog input range: -10 to 10V for CH1, 0 to 5V for CH2
- Average processing setting: Moving average for CH1 (16 times), count average for CH2 (16 times)
- An error is notified by an external output.

(2) System configuration

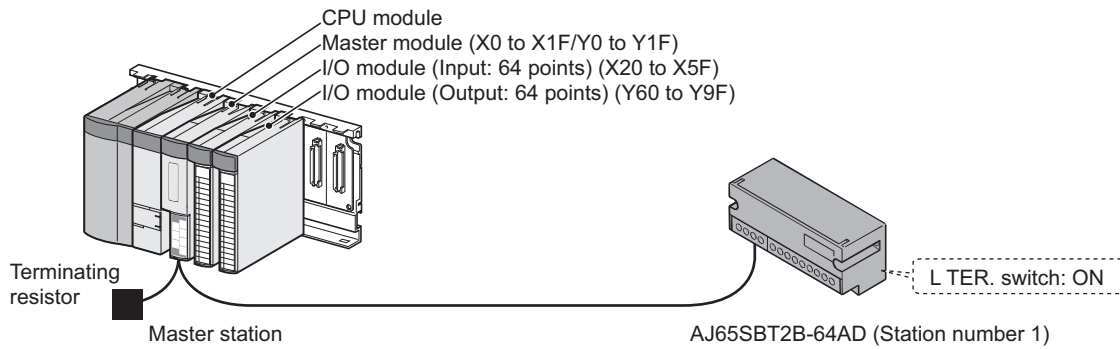

Figure 5.2 System configuration and wiring diagram

(3) Assignment relationship between remote I/O signals and remote registers

(a) For the QCPU (Q mode), LCPUCPU, and QnACPU

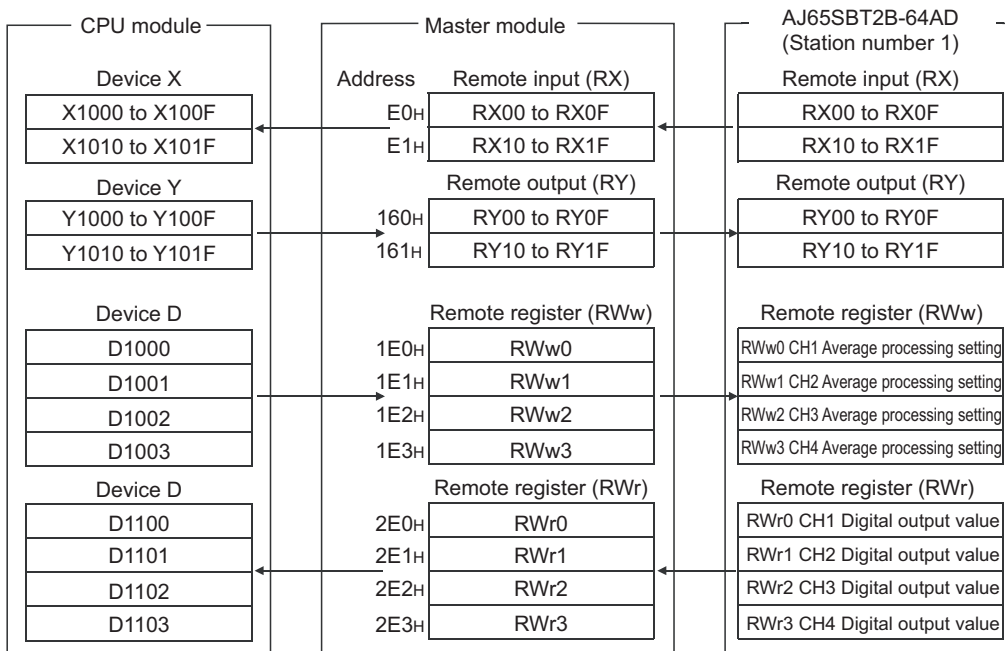
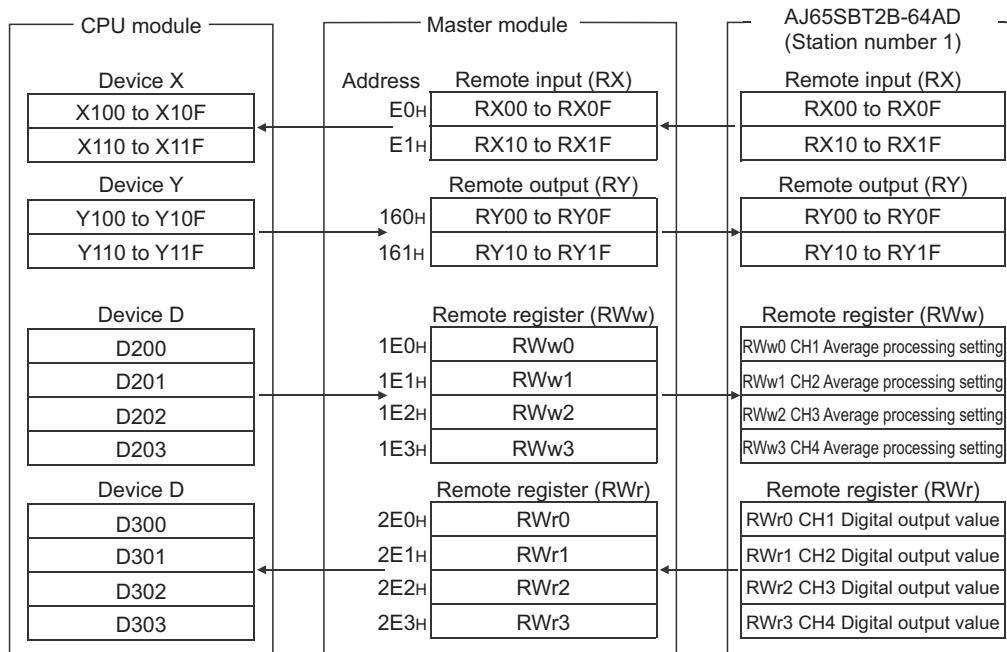

Figure 5.3 Update overview of the CPU module, master module, and AJ65SBT2B-64AD (For the QCPU (Q mode), LCPUCPU, QnACPU)

(b) For the ACPU and QCPU (A mode)



**Figure 5.4 Update overview of the CPU module, master module, and AJ65SBT2B-64AD (For the ACPU/QCPU (A mode))**

\* In a program example with the RRPA instruction (auto refresh parameter setting) for the ACPU/QCPU (A mode) (refer to Section 5.6), RWr0 to RWr3 are assigned to D456 to D459.

### POINT

The devices used in the examples in this chapter may not be available depending on the CPU module used.

For the available device setting range, refer to the user's manual for the CPU module used.

For example, X100 or Y100 and the subsequent devices are not available for the A1SCPU. Use other devices such as B and M.

## 5.3 Program Example When Using the QCPU (Q mode)

Set parameters in "Network Parameter" of GX Works2.

(1) Parameter settings

(a) Network parameter setting

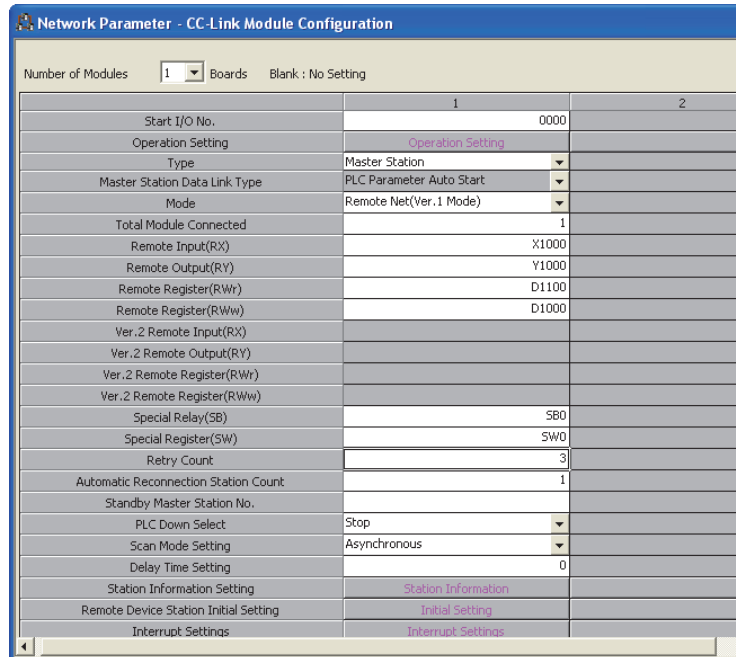

Figure 5.5 "CC-Link Module Configuration" dialog box (when using the QCPU (Q mode))

Table 5.1 "CC-Link Module Configuration" dialog box setting (when using the QCPU (Q mode))

Setting item	Setting value
Number of Modules	1 (Boards)
Start I/O No.	0000
Type	Master Station
Mode	Remote Net (Ver.1 Mode)
Total Module Connected	1 (module)
Remote Input(RX)	X1000
Remote Output(RY)	Y1000
Remote Register(RWr)	D1100
Remote Register(RWw)	D1000
Special Relay(SB)	SB0
Special Register(SW)	SW0
Retry Count	3 (Times)
Automatic Reconnection Station Count	1 (module)
Standby Master Station No.	No Setting
PLC Down Select	Stop
Scan Mode Setting	Asynchronous
Delay Time Setting	0
Station Information Setting	Refer to (1)(b) in this section.
Remote Device Station Initial Setting	No Setting
Interrupt Settings	No Setting

(b) Station information setting

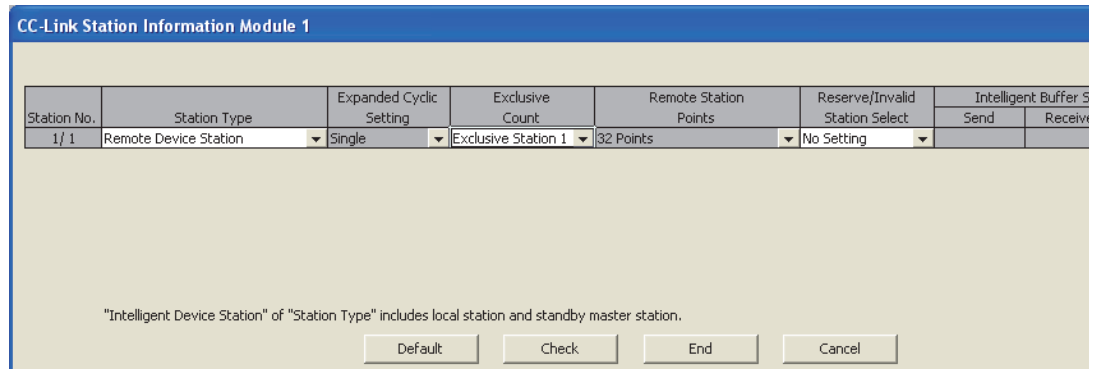

Figure 5.6 "Station Information Module 1" dialog box (when using the QCPU (Q mode))

Table 5.2 "Station Information Module 1" dialog box setting (when using the QCPU (Q mode))

Setting item	Setting value
Station Type	Remote Device Station
Exclusive Count	Exclusive Station 1
Reserve/Invalid Station Select	No Setting

## (2) List of devices used in the program example

Table 5.3 List of devices used in the program example (when using the QCPU (Q mode))

Device	Description
X0	Module error
X1	Host data link status
XF	Module ready
X21	Signal which is turned on to reset Error flag
X22	Signal which is turned on to change the initial settings
X1000	CH1 A/D conversion completion flag
X1001	CH2 A/D conversion completion flag
X100F	Test mode flag
X1018	Initial data processing request flag
X1019	Initial data setting completion flag
X101A	Error flag
X101B	Remote ready
Y60	Signal which is output when a data link error occurs
Y63	Signal which is output when an error occurs
Y1000 to Y101A	Signal for various settings of the AJ65SBT2B-64AD
M0	Signal where the data link status of the AJ65SBT2B-64AD is stored 0 (OFF): Data link is normal 1 (ON): Data link is error
M31	Reset command pulse signal for Error flag
M100	Master control (MC) contact
D500	Device which reads CH1 Digital output value (starts to read the value after CH1 A/D conversion completion flag turns on)
D501	Device which reads CH2 Digital output value (starts to read the value after CH2 A/D conversion completion flag turns on)
D1000	CH1 Average processing setting
D1001	CH2 Average processing setting
D1100	CH1 Digital output value
D1101	CH2 Digital output value
SW80	Other station data link status

### (3) Program example

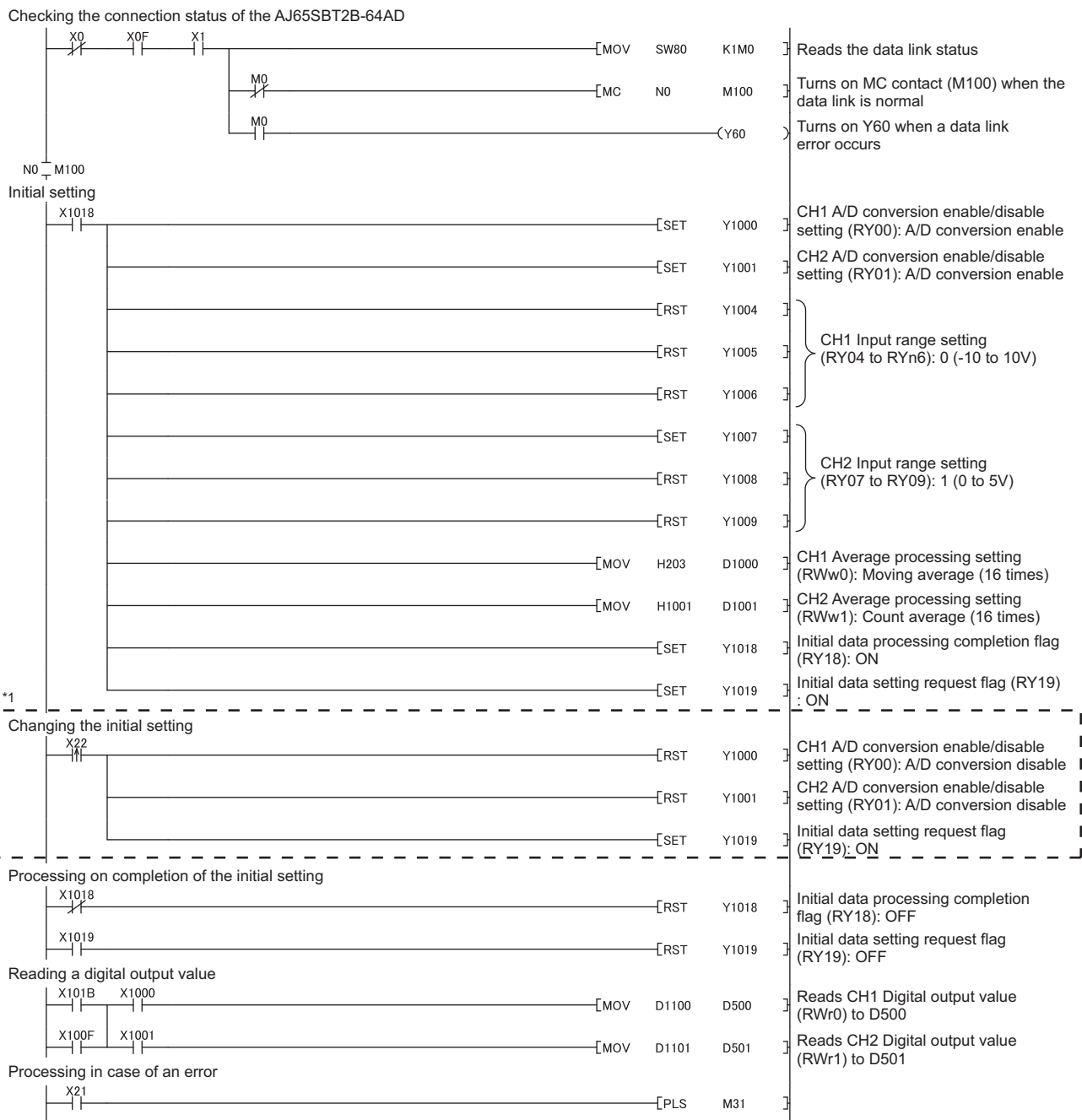

Figure 5.7 Program example (when using the QCPU (Q mode)) 1/2

\* 1 The program enclosed by the dotted line is required only when changing the initial settings.



Figure 5.8 Program example (when using the QCPU (Q mode)) 2/2



## 5.4 Program Example When Using the LCPU

The program example when using the QCPU can also be used for the LCPU. Set parameters according to the description in this section and use the program example in Section 5.3 (3).

Set parameters in "Network Parameter" of GX Works2.

### (1) Parameter settings

#### (a) PLC parameter

Change the I/O assignment setting of the built-in I/O function according to the program example for the QCPU. From "I/O Assignment" of "PLC Parameter", set the I/O assignment not used in the system. Figure 5.9 shows an example of "I/O Assignment" for the L02CPU.

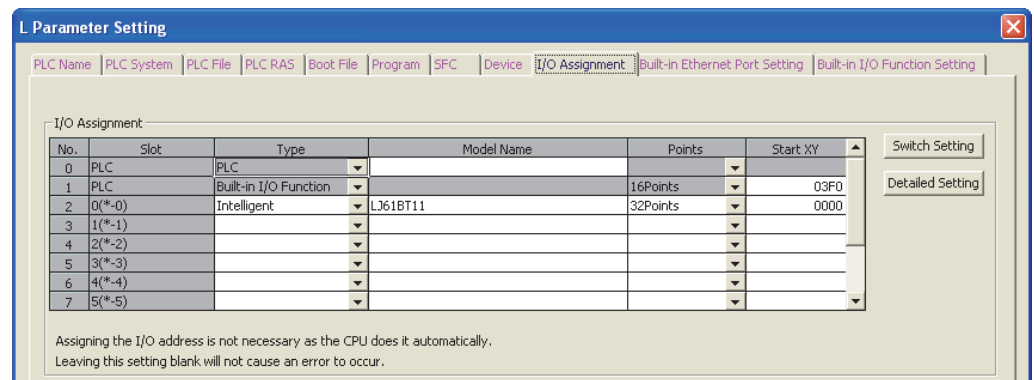

Figure 5.9 "PLC Parameter" dialog box (when using the L02CPU)

When using the LCPU with the built-in CC-Link function, set the I/O assignment of the built-in CC-Link function to 0000, and set the start I/O No. of the built-in I/O function to the I/O assignment which is not used in the system.

(b) Network parameter setting

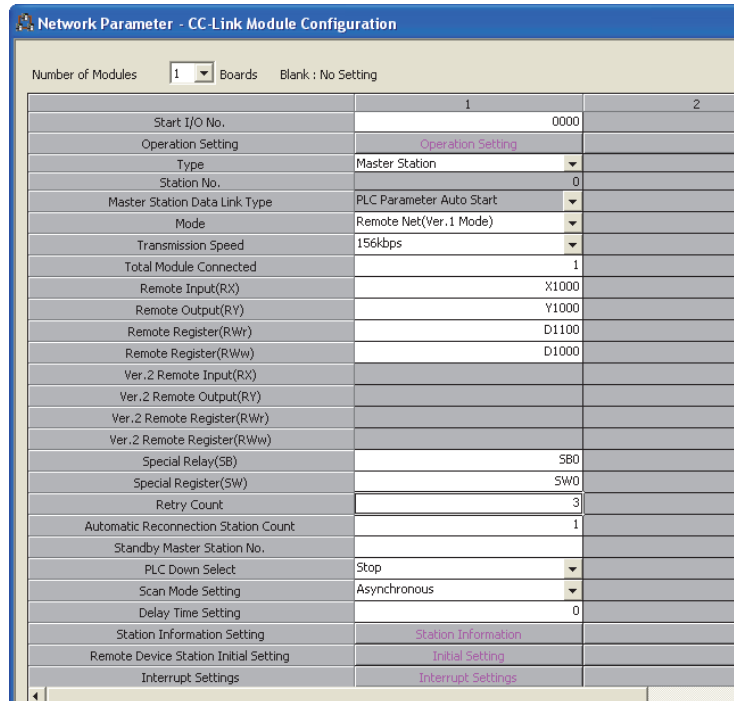

Figure 5.10 "CC-Link Module Configuration" dialog box (when using the LCPU)

Table 5.4 "CC-Link Module Configuration" dialog box setting (when using the LCPU)

Setting item	Setting value
Number of Modules	1 (Boards)
Start I/O No.	0000
Type	Master Station
Mode	Remote Net (Ver.1 Mode)
Transmission Speed	156kbps
Total Module Connected	1 (module)
Remote Input(RX)	X1000
Remote Output(RY)	Y1000
Remote Register(RWr)	D1100
Remote Register(RWw)	D1000
Special Relay(SB)	SB0
Special Register(SW)	SW0
Retry Count	3 (Times)
Automatic Reconnection Station Count	1 (module)
Standby Master Station No.	No Setting
PLC Down Select	Stop
Scan Mode Setting	Asynchronous
Delay Time Setting	0
Station Information Setting	Refer to (1)(c) in this section.
Remote Device Station Initial Setting	No Setting
Interrupt Settings	No Setting

(c) Station information setting

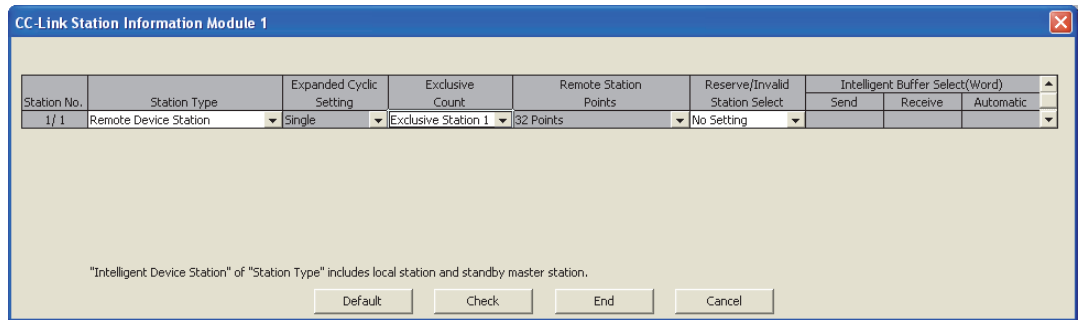

Figure 5.11 "Station Information Module 1" dialog box (when using the LCPU)

Table 5.5 "Station Information Module 1" dialog box setting (when using the LCPU)

Setting item	Setting value
Station Type	Remote Device Station
Exclusive Count	Exclusive Station 1
Reserve/Invalid Station Select	No Setting

(2) Program example

Refer to Section 5.3 (2) and Section 5.3 (3), and use the program example for the QCPU.

**Remark**

To configure the system with the default I/O assignment of the LCPU, change some devices of the program example in Section 5.3 (3) to the ones indicated in Table 5.6.

Table 5.6 List of devices used in the program example (when using the LCPU)

Device	Changed to	Description
X0	X10	Module error
X1	X11	Host data link status
XF	X1F	Module ready
X21	X31	Signal which is turned on to reset Error flag
X22	X32	Signal which is turned on to change the initial settings

## 5.5 Program Example When Using the QnACPU

Set parameters in "Network parameters" of GX Developer.

(1) Parameter settings

(a) Network parameter setting

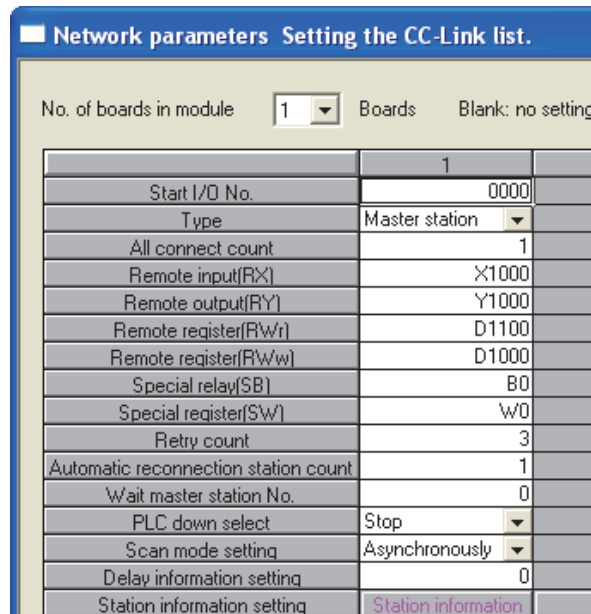

Figure 5.12 "Setting the CC Link List" dialog box (when using the QnACPU)

Table 5.7 "Setting the CC Link List" dialog box setting (when using the QnACPU)

Setting item	Setting value
No. of boards in module	1 (Boards)
Start I/O No.	0000
Type	Master station
All connect count	1 (module)
Remote input(RX)	X1000
Remote output(RY)	Y1000
Remote register(RWr)	D1100
Remote register(RWw)	D1000
Special relay(SB)	B0
Special register(SW)	W0
Retry count	3 (Times)
Automatic reconnection station count	1 (module)
Wait master station No.	0
PLC down select	Stop
Scan mode setting	Asynchronously
Delay information setting	0
Station information setting	Refer to (1)(b) in this section.

(b) Station information setting

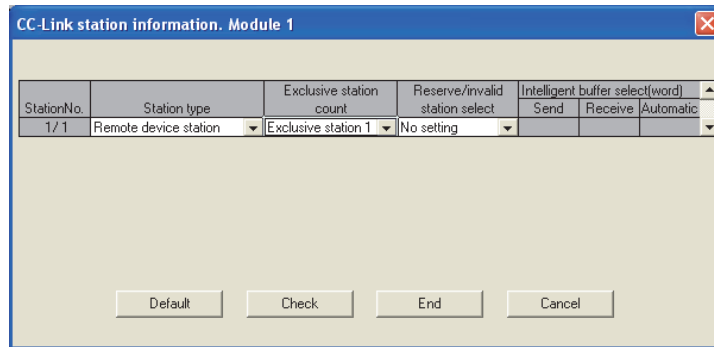

Figure 5.13 "station Information. Module 1" dialog box (when using the QnACPU)

Table 5.8 "station Information. Module 1" dialog box setting (when using the QnACPU)

Setting item	Setting value
Station type	Remote device station
Exclusive station count	Exclusive station 1
Reserve/invalid station select	No setting

## (2) List of devices used in the program example

Table 5.9 List of devices used in the program example (when using the QnACPU)

Device	Description
X0	Module error
X1	Data link status at host station
XF	Module ready
X21	Signal which is turned on to reset Error flag
X22	Signal which is turned on to change the initial settings
X1000	CH1 A/D conversion completion flag
X1001	CH2 A/D conversion completion flag
X100F	Test mode flag
X1018	Initial data processing request flag
X1019	Initial data setting completion flag
X101A	Error flag
X101B	Remote ready
Y60	Signal which is output when a data link error occurs
Y63	Signal which is output when an error occurs
Y1000 to Y101A	Signal for various settings of the AJ65SBT2B-64AD
M0	Signal where the data link status of the AJ65SBT2B-64AD is stored 0 (OFF): Data link is normal 1 (ON): Data link is error
M31	Reset command pulse signal for Error flag
M100	Master control (MC) contact
D500	Device which reads CH1 Digital output value (starts to read the value after CH1 A/D conversion completion flag turns on)
D501	Device which reads CH2 Digital output value (starts to read the value after CH2 A/D conversion completion flag turns on)
D1000	CH1 Average processing setting
D1001	CH2 Average processing setting
D1100	CH1 Digital output value
D1101	CH2 Digital output value
W80	Other station data link status

## (3) Program example

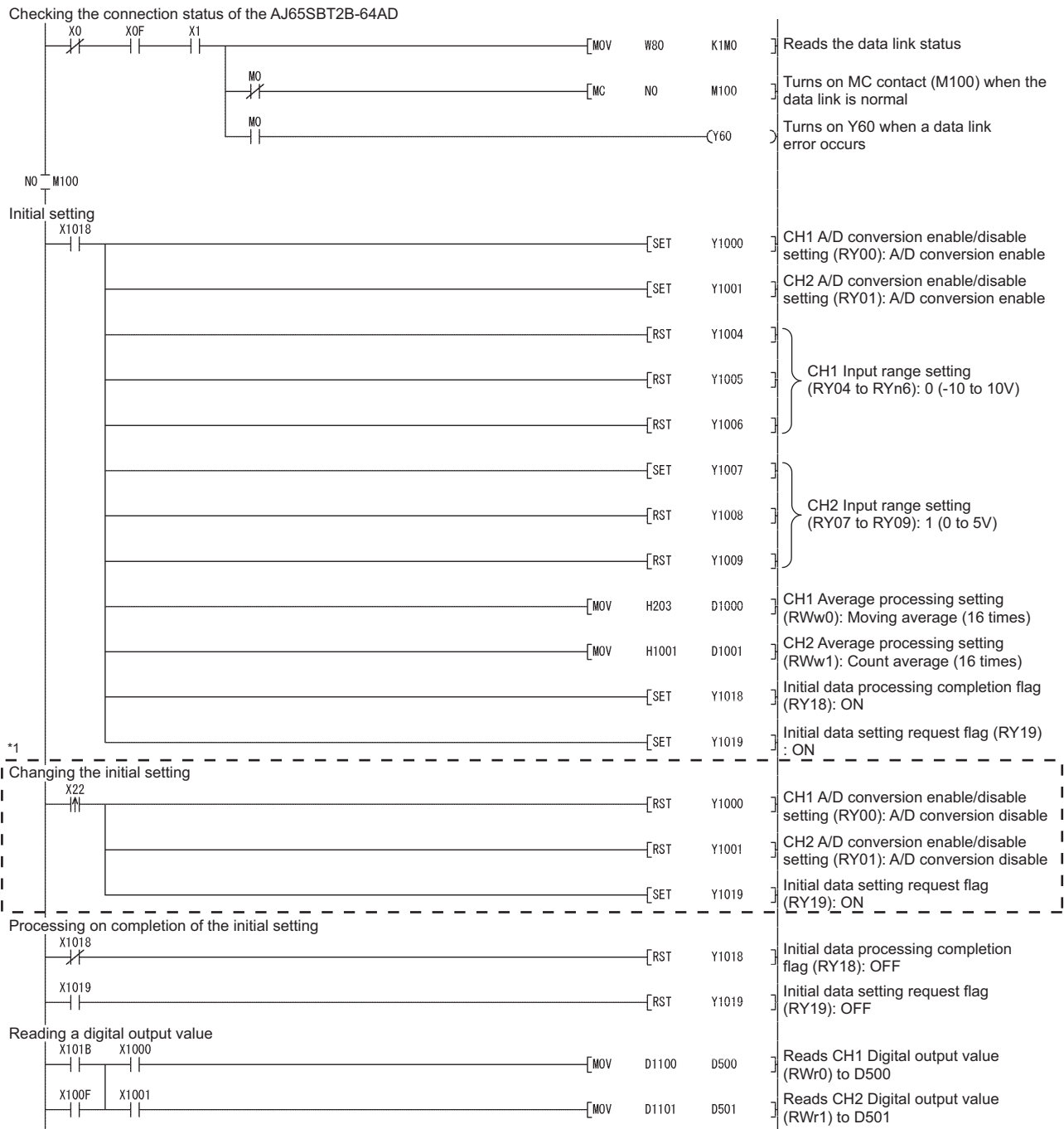

Figure 5.14 Program example (when using the QnACPU) 1/2

\* 1 The program enclosed by the dotted line is required only when changing the initial settings.

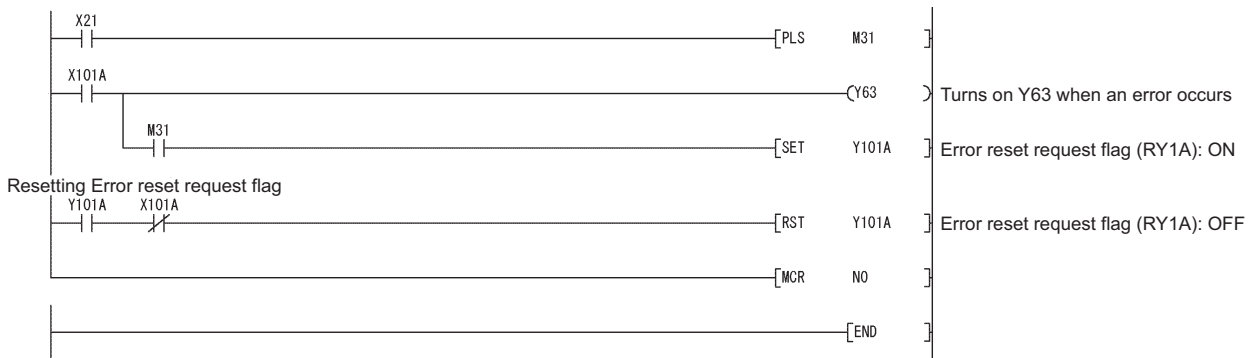

Figure 5.15 Program example (when using the QnACPU) 2/2



## 5.6 Program Example When Using the ACPU/QCPU (A mode) (Dedicated Instructions)

Set parameters with a sequence program.

For details on the dedicated instruction, refer to the Type AnSHCPU/AnACPU/AnUCPU/QCPU-A (A Mode) Programming Manual (Dedicated Instructions).

### (1) List of devices used in the program example

**Table 5.10 List of devices used in the program example (when using the ACPU/QCPU (A mode) (dedicated instructions))**

Device	Description
X0	Module error
X1	Data link status at host station
XF	Module ready
X21	Signal which is turned on to reset Error flag
X22	Signal which is turned on to change the initial settings
X100	CH1 A/D conversion completion flag
X101	CH2 A/D conversion completion flag
X10F	Test mode flag
X118	Initial data processing request flag
X119	Initial data setting completion flag
X11A	Error flag
X11B	Remote ready
Y60	Signal which is output when a data link error occurs
Y63	Signal which is output when an error occurs
Y100 to Y11A	Signal for various settings of the AJ65SBT2B-64AD
M0	Signal where the data link status of the AJ65SBT2B-64AD is stored 0 (OFF): Data link is normal 1 (ON): Data link is error
M10	Network parameter setting start pulse signal
M11	Signal which is turned on when the parameter setting is completed normally
M12	Signal which is turned on when the parameter setting is completed in error
M13	Auto refresh parameter setting start pulse signal
M20	Initial setting change command pulse signal
M31	Reset command pulse signal for Error flag
M100	Master control (MC) contact
D0 to D2	Device for network parameter settings
D3	Device where the own station parameter status is stored when the instruction is completed in error
D10 to D29	Device which configures auto refresh parameter settings
D200	CH1 Average processing setting
D201	CH2 Average processing setting
D456	CH1 Digital output value
D457	CH2 Digital output value
D500	Device which reads CH1 Digital output value (starts to read the value after CH1 A/D conversion completion flag turns on)
D501	Device which reads CH2 Digital output value (starts to read the value after CH2 A/D conversion completion flag turns on)
W80	Other station data link status

## (2) Program example

Setting the network parameter using the RLPA instruction

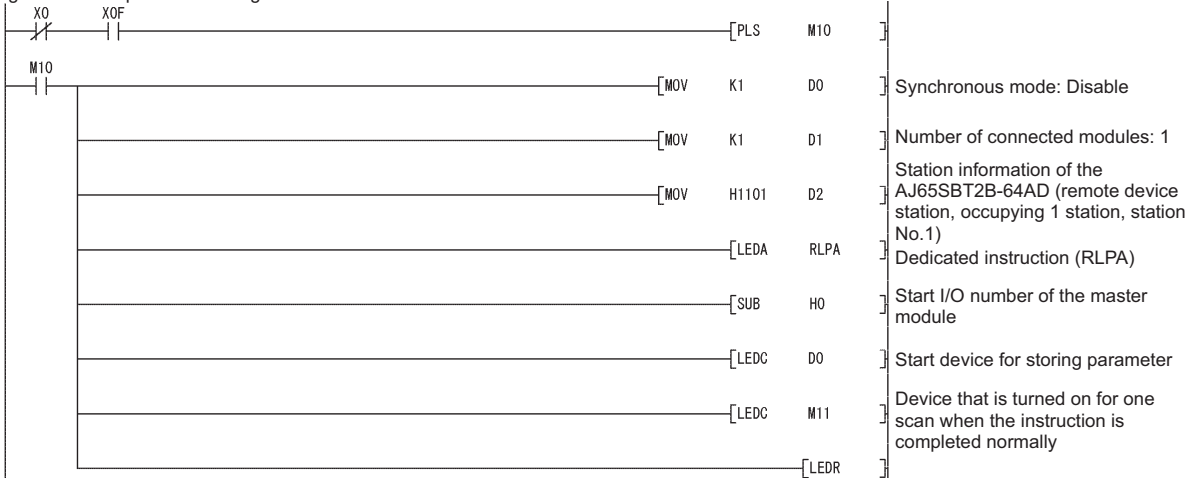

M12 [FROM H0 H668 D3 K1] Reads the host station parameter status when the instruction is completed in error

Setting the auto refresh parameter using the RLPA instruction

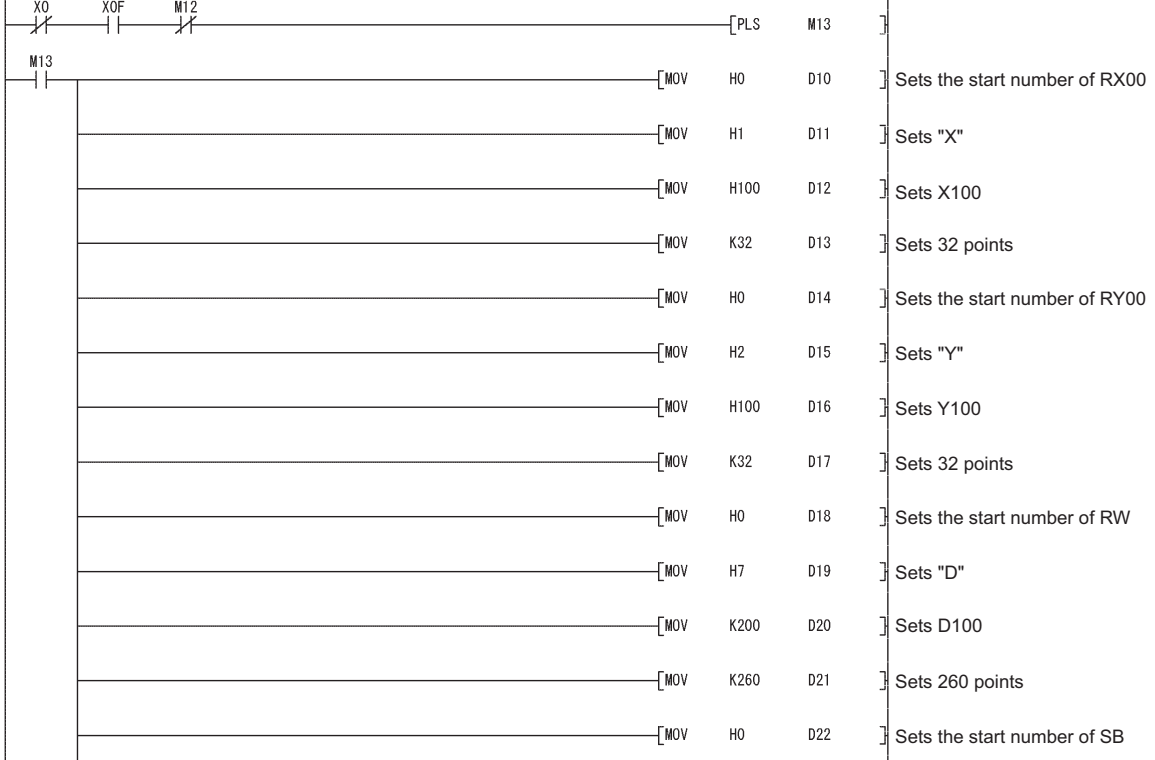

Figure 5.16 Program example (when using the ACPU/QCPU (A mode) (dedicated instructions)) 1/3

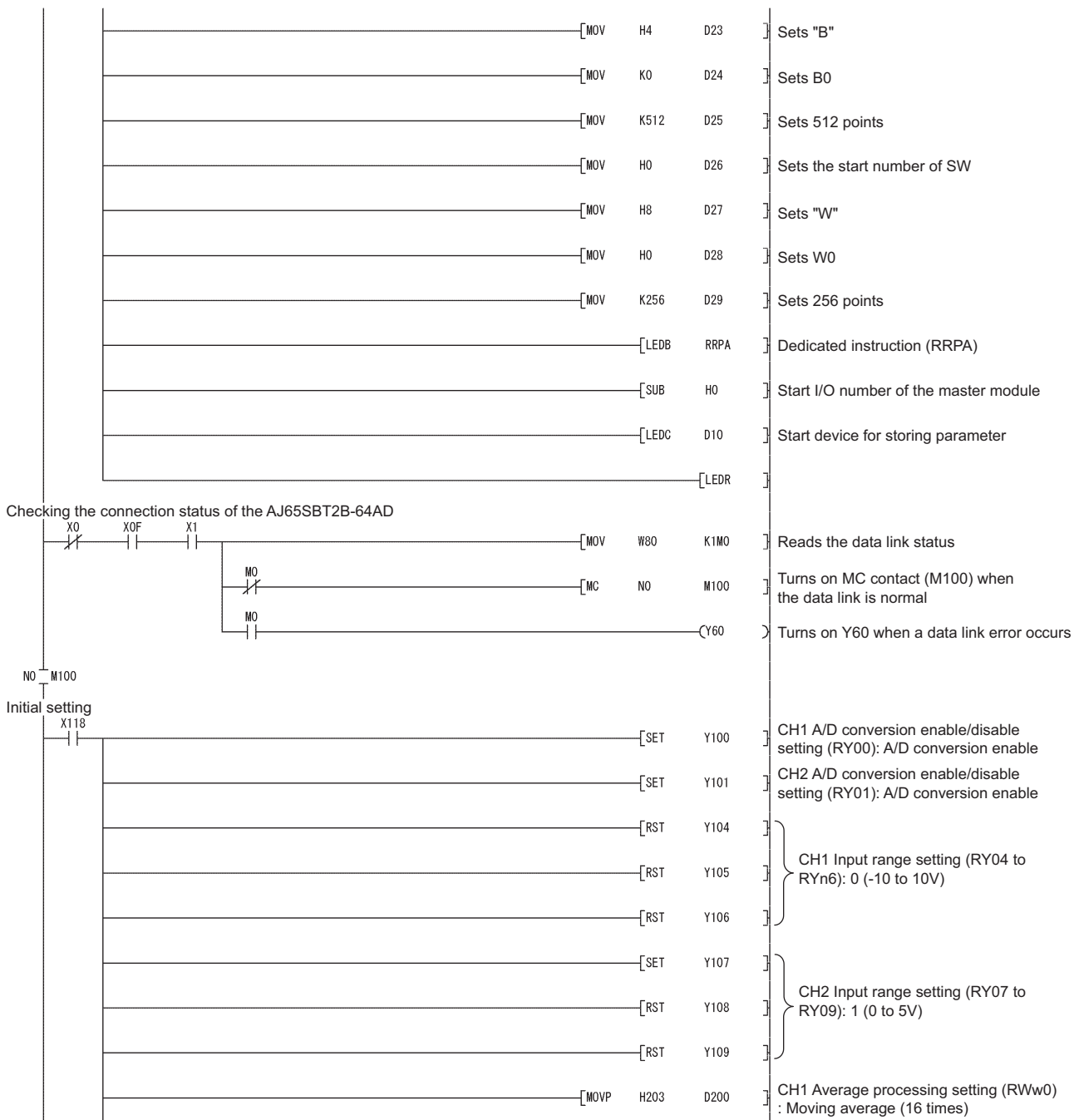

Figure 5.17 Program example (when using the ACPU/QCPU (A mode) (dedicated instructions)) 2/3

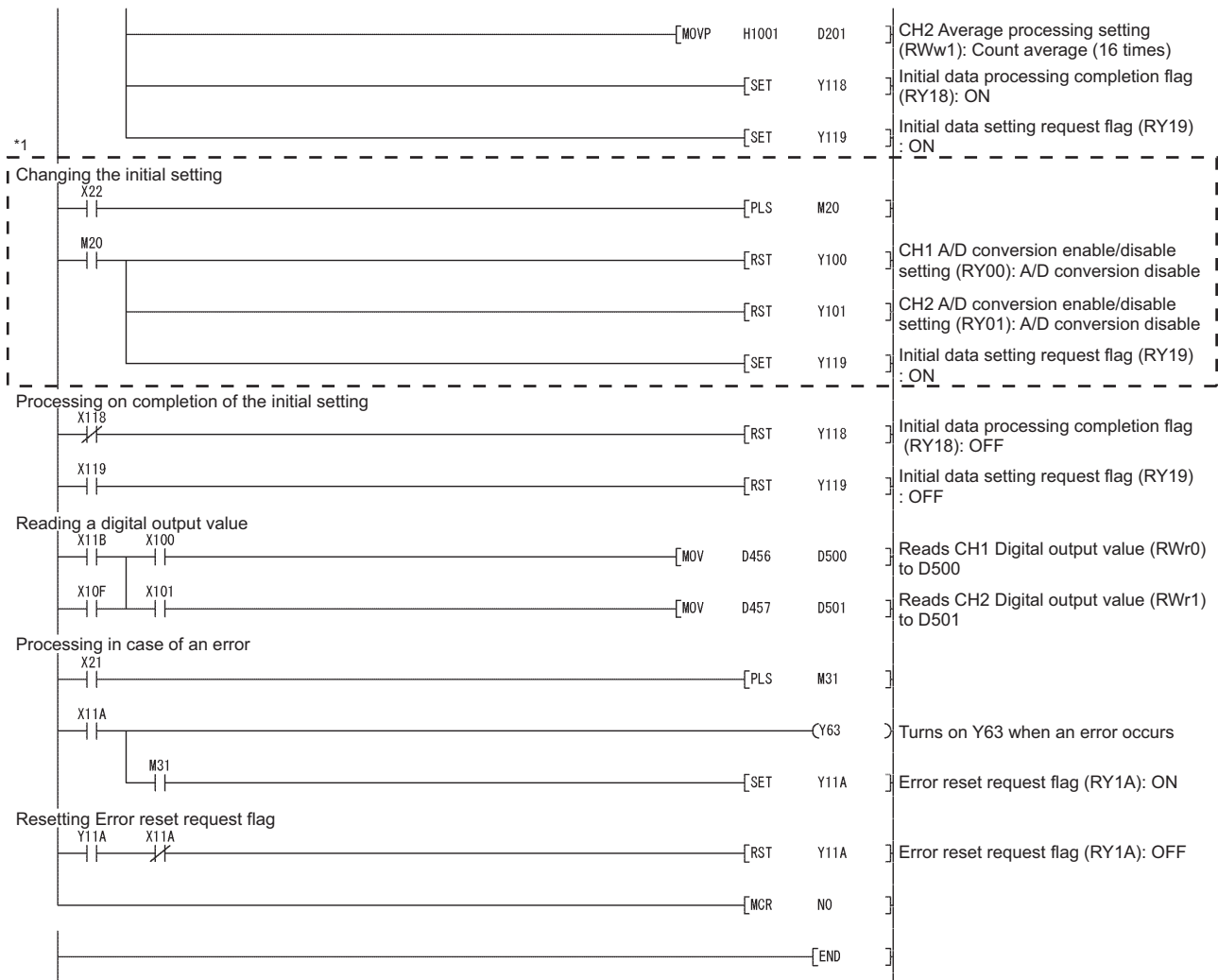

Figure 5.18 Program example (when using the ACPU/QCPU (A mode) (dedicated instructions)) 3/3

\* 1 The program enclosed by the dotted line is required only when changing the initial settings.

## 5.7 Program Example When Using the ACPU/QCPU (A mode) (FROM/TO Instructions)

Set parameters with a sequence program.

### (1) List of devices used in the program example

**Table 5.11 List of devices used in the program example (when using the ACPU/QCPU (A mode) (FROM/TO instructions))**

Device	Description
X0	Module error
X1	Data link status at host station
X6	Data link startup by buffer memory parameter normal completion
X7	Data link startup by buffer memory parameter error completion
XF	Module ready
X21	Signal which is turned on to reset Error flag
X22	Signal which is turned on to change the initial settings
X100	CH1 A/D conversion completion flag
X101	CH2 A/D conversion completion flag
X10F	Test mode flag
X118	Initial data processing request flag
X119	Initial data setting completion flag
X11A	Error flag
X11B	Remote ready
Y0	Refresh instruction
Y6	Data link startup request from buffer memory parameters
Y60	Signal which is output when a data link error occurs
Y63	Signal which is output when an error occurs
Y100 to Y11A	Signal for various settings of the AJ65SBT2B-64AD
M0	Signal where the data link status of the AJ65SBT2B-64AD is stored 0 (OFF): Data link is normal 1 (ON): Data link is error
M10	Network parameter setting start pulse signal
M20	Initial setting change command pulse signal
M31	Reset command pulse signal for Error flag
M100	Master control (MC) contact
D0 to D4	Device for network parameter settings
D100	Device where the own station parameter status is stored when the instruction is completed in error
D200	CH1 Average processing setting
D201	CH2 Average processing setting
D300	CH1 Digital output value
D301	CH2 Digital output value

## (2) Program example

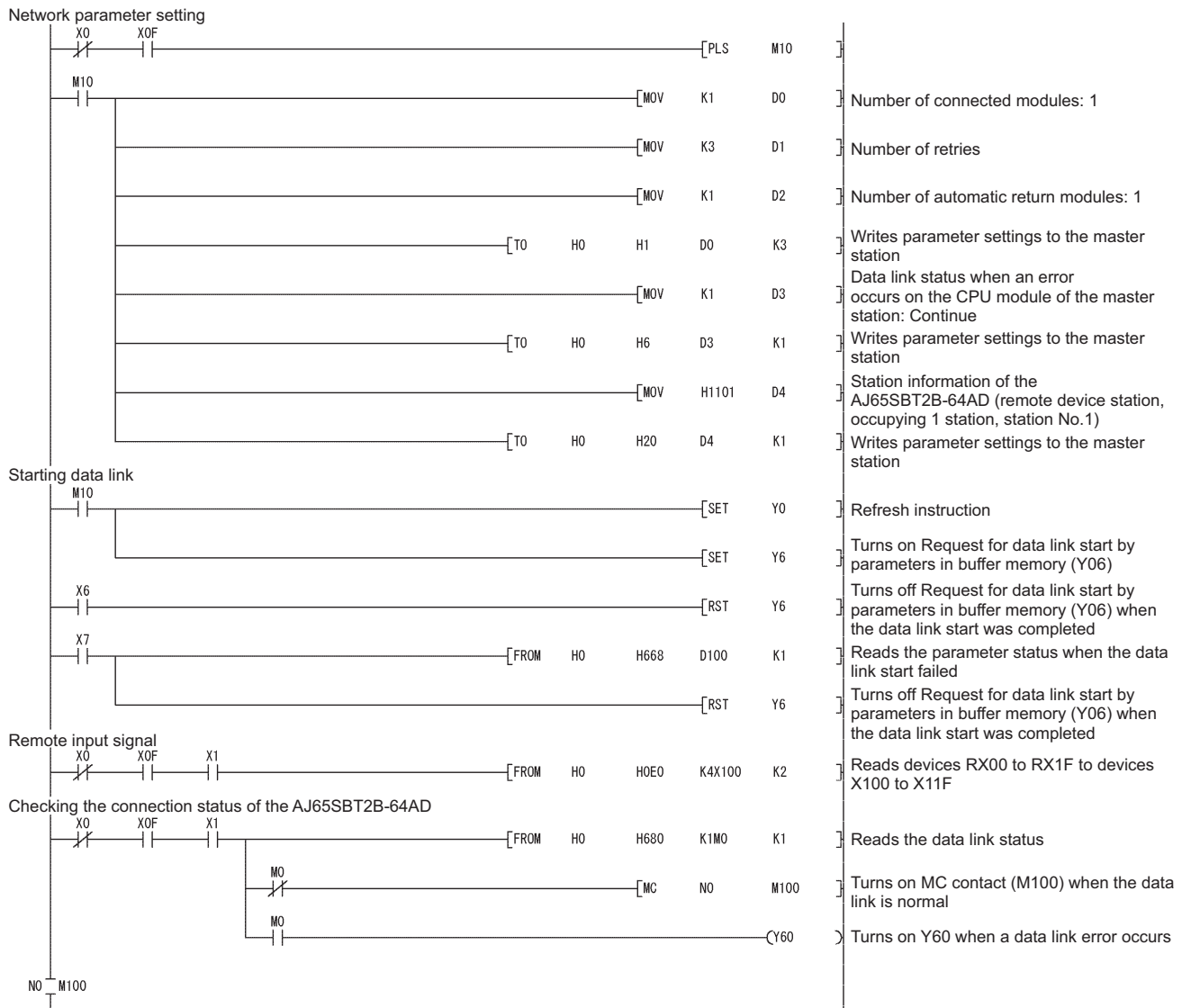

Figure 5.19 Program example (when using the ACPU/QCPU (A mode) (FROM/TO instructions)) 1/3

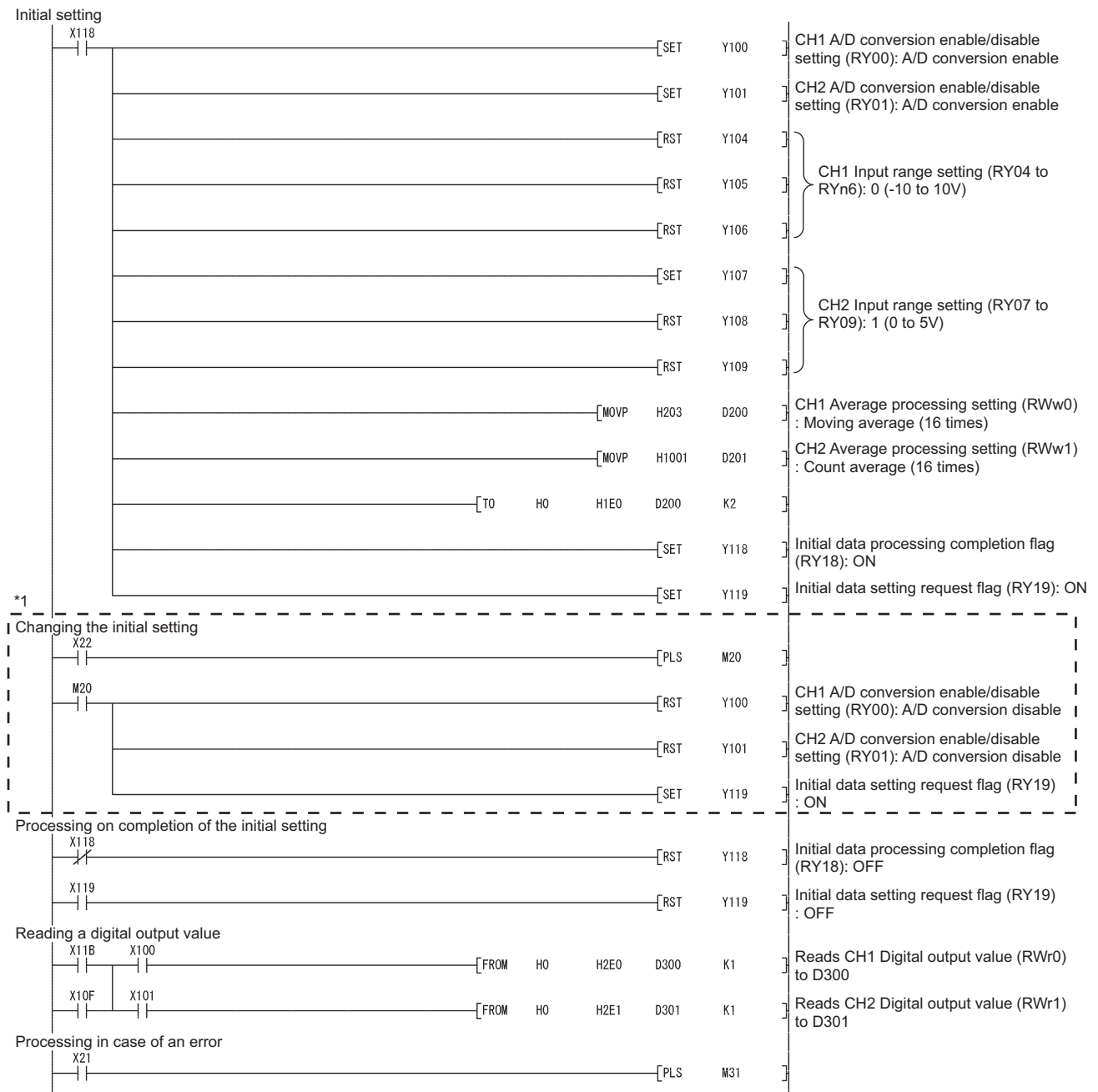

Figure 5.20 Program example (when using the ACPU/QCPU (A mode) (FROM/TO instructions)) 2/3

\* 1 The program enclosed by the dotted line is required only when changing the initial settings.

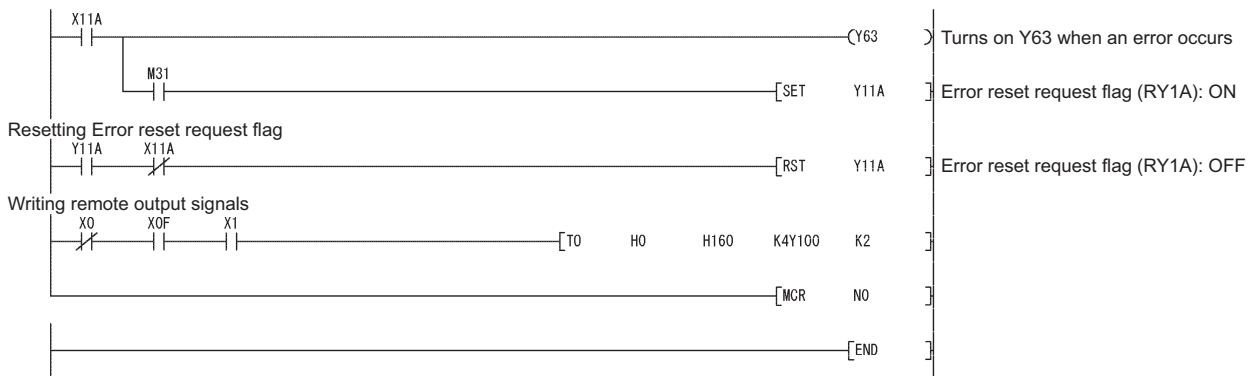

Figure 5.21 Program example (when using the ACPU/QCPU (A mode) (FROM/TO instructions)) 3/3



## CHAPTER 6 TROUBLESHOOTING

This chapter describes error contents that may occur while using the AJ65SBT2B-64AD and troubleshooting.

### 6.1 Error Check Method by the LED Display

This section describes how to check errors by the LED display of the AJ65SBT2B-64AD. For errors related to the CPU module and the master module, refer to the user's manual for the modules.

(1) When the PW LED turns off

Table 6.1 When the PW LED of the AJ65SBT2B-64AD turns off

Check item	Action
Is the 24VDC power supply turned on?	Check the external power supply.
Is the voltage of the 24VDC power supply within the specified range?	Set the voltage value within the range of 20.4 to 28.8V.

(2) When the RUN LED flashes

Table 6.2 When the RUN LED of the AJ65SBT2B-64AD flashes

	Flash interval	Check item	Action
Normal mode	0.1s	Are the values of CH1 Input range setting (0th bit) (RYn4) to CH4 Input range setting (2nd bit) (RYnF) correct?	Referring to Section 3.4.4, check CH1 Input range setting (0th bit) (RYn4) to the CH4 Input range setting (2nd bit) (RYnF). If a setting value of a channel is wrong, set it to a correct value.
		Is Hardware error flag (RXnA) ON?	Turn the power supply of the AJ65SBT2B-64AD from off to on. If the same error occurs again, the possible cause is a hardware failure. Please consult your local Mitsubishi representative.
		Is User range read error flag (RXnB) ON?	Configure the offset/gain setting again for all channels where the user range setting is used in test mode. If the same error occurs again even after the offset/gain setting is configured correctly, the possible cause is a hardware failure. Please consult your local Mitsubishi representative.
	0.5s	Are the values of CH1 Average processing setting (RWwm) to CH4 Average processing setting (RWwm+3) correct?	Referring to Section 3.4.3, check CH1 Average processing setting (RWwm) to CH4 Average processing setting (RWwm+3). If a setting value of a channel is wrong, set it to a correct value.

Table 6.2 When the RUN LED of the AJ65SBT2B-64AD flashes

	Flash interval	Check item	Action
Test mode	0.1s	Is User range read error flag (RXnB) ON?	Configure the offset/gain setting again for all channels where the user range setting is used in test mode. If the same error occurs again even after the offset/gain setting is configured correctly, the possible cause is a hardware failure. Please consult your local Mitsubishi representative.
		Is Flash memory write error flag (RXnC) ON?	This flag turns on if the write to the flash memory is failed when configuring the offset/gain setting. In this case, turn the power supply of the AJ65SBT2B-64AD from off to on. If Flash memory write error flag (RXnC) is still ON even after turning the power supply from off to on and performing the write to the flash memory, the possible cause is a hardware failure. Please consult your local Mitsubishi representative.
		Are User range read error flag (RXnB) and Flash memory write error flag (RXnC) OFF?	Turn the power supply of the AJ65SBT2B-64AD from off to on. If the state remains the same even after turning the power supply from off to on, the possible cause is a hardware failure. Please consult your local Mitsubishi representative.
	0.5s	Are the offset value and gain value set within the available setting range?	Referring to Section 3.3.1 and Section 3.3.2, check the available setting range of the offset value and gain value and reset the error by turning on Error reset request flag (RY(n+1)A). Then, set the offset value and gain value to the correct value.

## (3) When the RUN LED turns off

Table 6.3 When the RUN LED of the AJ65SBT2B-64AD turns off

Check item	Action
Does the watchdog timer error occur?	After checking the watchdog timer error with the link special register (SW0084 to SW0087) of the master module, turn the power supply of the AJ65SBT2B-64AD from off to on. If the RUN LED does not turn on even after turning the power supply from off to on, the possible cause is a hardware failure. Please consult your local Mitsubishi representative.
Is the AJ65SBT2B-64AD in test mode by short-circuiting between the TEST terminals?	After configuring the offset/gain setting, release the TEST terminals.

## (4) When the L RUN LED turns off

Communication is disconnected.

For details, refer to the troubleshooting on the user's manual for the master module used.

(5) When the L ERR. LED flashes regularly

**Table 6.4 When the L ERR. LED of the AJ65SBT2B-64AD flashes regularly**

Check item	Action
Is the station number setting switch changed during normal operation?	Turn off the power supply of the AJ65SBT2B-64AD, correct the setting of the station number setting switch, and turn the power supply from off to on.
Is the station number setting switch broken?	If the L ERR. LED starts flashing although the station number setting switch is not changed during the operation, the possible cause is a hardware failure. Please consult your local Mitsubishi representative.

(6) When the L ERR. LED flashes irregularly

**Table 6.5 When the L ERR. LED flashes irregularly**

Check item	Action	
Is the module or CC-Link dedicated cable affected by noise?	Ground both ends of the shield part of the CC-Link dedicated cable to the protective ground conductor via the SLD and FG terminals of each module. Ground the FG terminal of the module without fail. When wiring is performed using pipes, ground the pipes without fail.	
Is the communication disconnected?	The station number setting switch may be changed while the communication is disconnected. In this case, check all the items described in Section 6.1 (5) and take an appropriate action.	
When the AJ65SBT2B-64AD is not connected at the network termination	Is the L TER. switch ON?	Turn off the L TER. switch.
	Is a terminating resistor connected?	Remove the terminating resistor.
When the AJ65SBT2B-64AD is connected at the network termination	Is the L TER. switch ON or a terminating resistor installed?	Remove the terminating resistor. Or, turn off the L TER. switch.
	Is the L TER. switch OFF or a terminating resistor forgotten to be installed?	Turn on the L TER. switch. Or, connect a terminating resistor. After completing either of the above actions, turn the power supply from off to on.

(7) When the L ERR. LED turns on

**Table 6.6 When the L ERR. LED of the AJ65SBT2B-64AD turns on**

Check item	Action
Is the station number setting correct?	Set the correct station number.

## 6.2 When the Digital Output Value Cannot Be Read

Table 6.7 When the digital output value cannot be read

Check item	Action
Does an error occur in a CPU module or the master module?	Check the CPU module or the master module. When an error occurs, refer to the user's manual of the CPU module or the master module used and resolve the error.
Is the input range setting correct?	Referring to Section 3.4.4, check CH□ Input range setting (RYn4 to RYnF) in the monitor of the programming tool. If the input range setting is wrong, correct the sequence program.
Is the A/D conversion disabled in CH□ A/D conversion enable/disable setting (RYn0 to RYn3) for the channel to be used?	Referring to Section 3.4.2, check CH□ A/D conversion enable/disable setting (RYn0 to RYn3) in the monitor of the programming tool. When the setting is wrong, correct the sequence program.
Are analog signal lines connected properly or unbroken?	Identify the failure location by visual check or cable check, and re-wire the cables.
Are the V+ and I+ terminals connected for the current input?	When executing the current input, wire between the V+ and I+ terminals.
Is the terminal block for analog input signal mounted on the module?	Check the connection of the terminal block for analog input signal. If it is not connected, connect it to the module.
Is the module affected by noise?	Check the influence of the noise from the grounded point or adjacent equipment, and take an action against the noise.

## 6.3 When the Data Link Needs a Lot of Time

Table 6.8 When the data link needs a lot of time

Check item	Action
Is the setting value of the Automatic Reconnection Station Count of the master module small?	Set the setting value of the "Automatic Reconnection Station Count" in the "Network Parameter" on the programming tool. For details on the setting method, refer to the user's manual for the used master module.

## 6.4 Troubleshooting When the ERR. LED of the Master Station Flashes

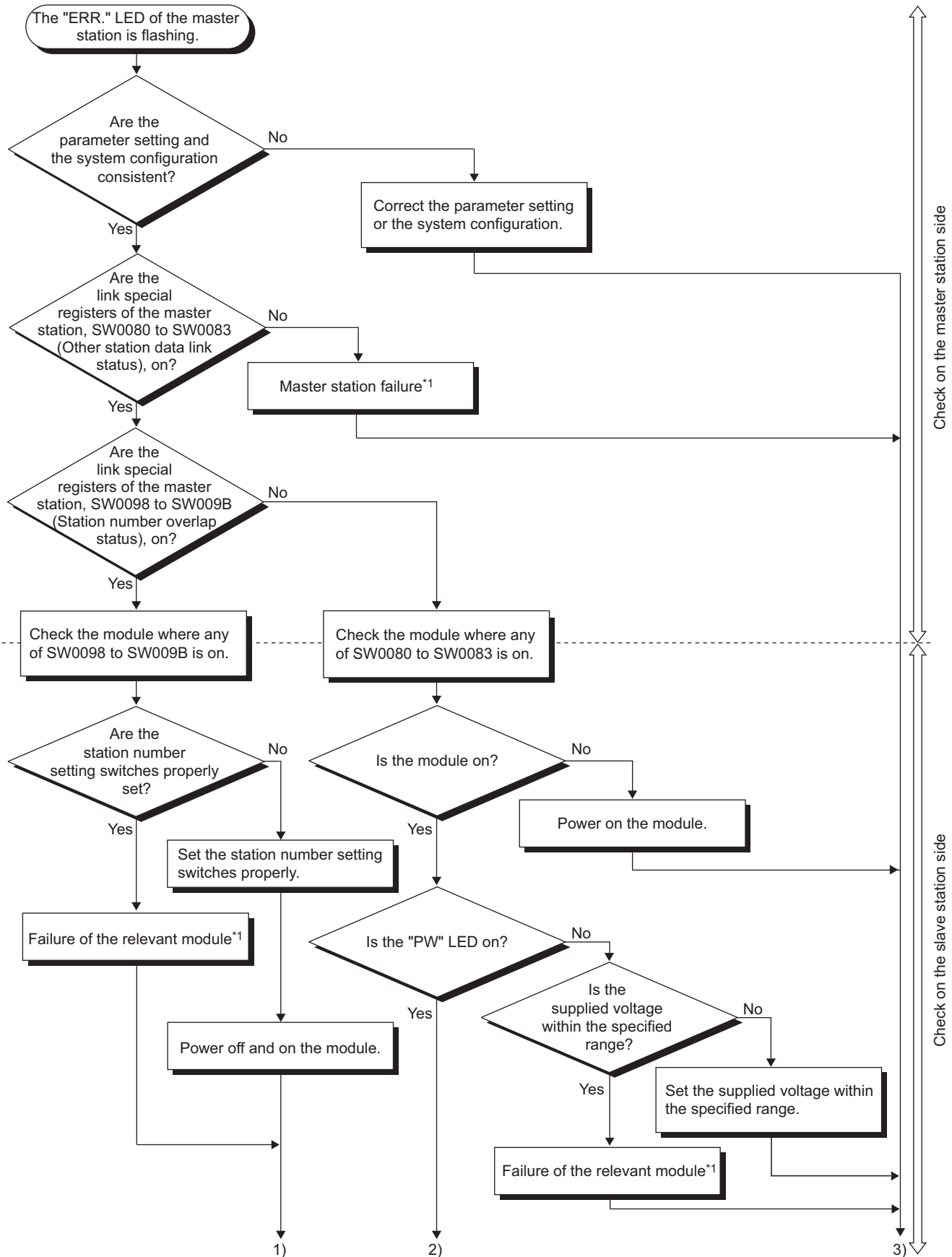

1	OVERVIEW
2	SYSTEM CONFIGURATION
3	SPECIFICATIONS
4	SETTINGS AND THE PROCEDURE BEFORE OPERATION
5	PROGRAMMING
6	<b>6 TROUBLESHOOTING</b>
	APPENDIX
	INDEX

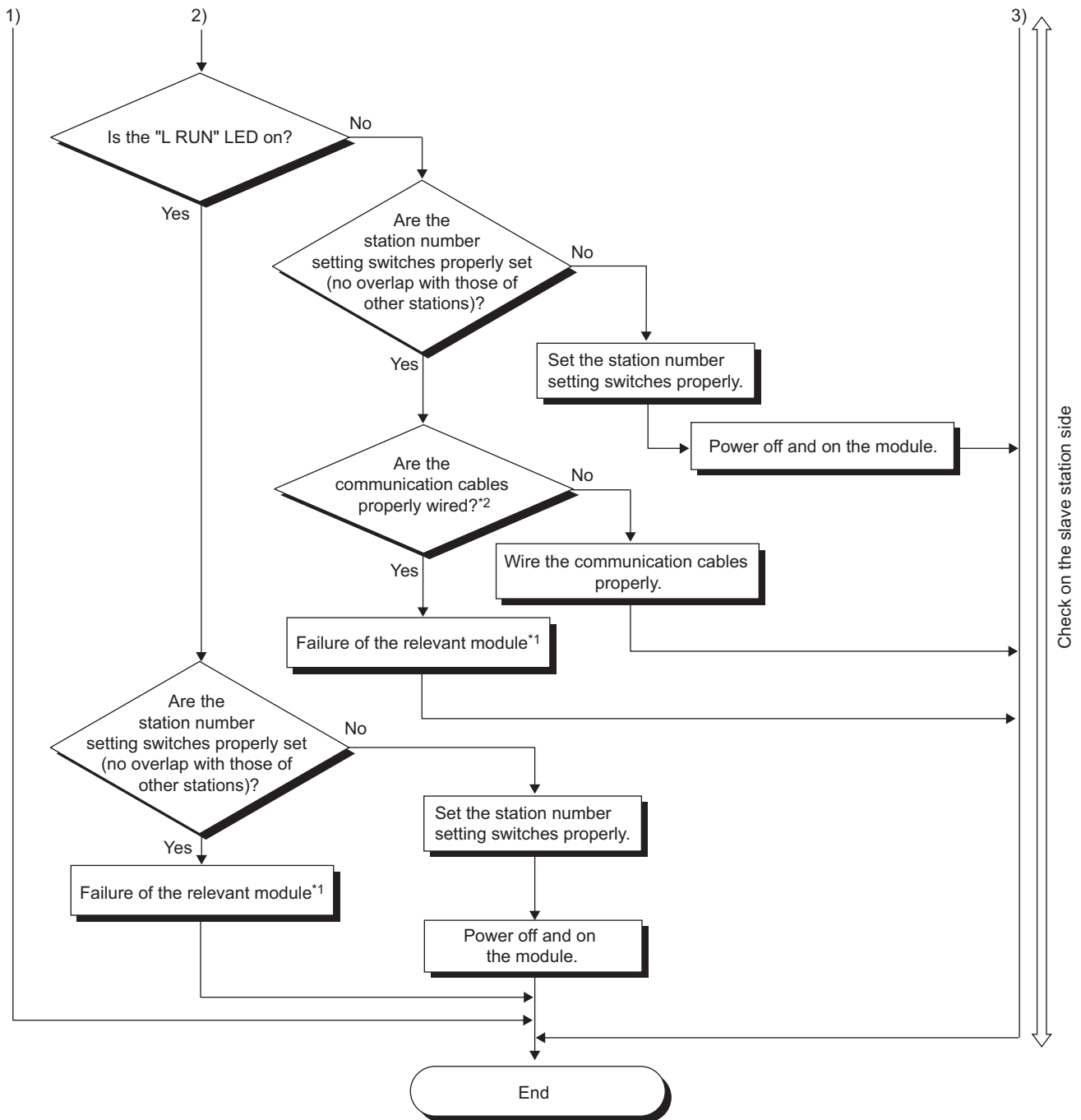

\* 1 For the failure of the master module or corresponding modules, please consult your local Mitsubishi representative.

\* 2 Check for a short circuit, reversed connection, disconnection, terminating resistor, FG connection, overall cable distance, and station-to-station distance.

## 6.5 When Hardware Error Flag (RXnA) Turns on

---

In this case, turn the power supply of the AJ65SBT2B-64AD from off to on.  
If Hardware error flag (RXnA) turns on even after turning the power supply from off to on, the possible cause is a failure of the AJ65SBT2B-64AD.  
Please consult your local Mitsubishi representative.

## 6.6 When User Range Read Error Flag (RXnB) Turns on

---

An error has occurred while reading the user range.

In this case, configure the offset/gain setting again for all channels where the user range setting is used.  
If User range read error flag (RXnB) is still ON even after configuring the offset/gain setting again, the possible cause is a failure of the AJ65SBT2B-64AD. Please consult your local Mitsubishi representative.

## 6.7 When Flash Memory Write Error Flag (RXnC) Turns on

---

Writing to the flash memory failed when configuring the offset/gain setting.

In this case, turn the power supply of the AJ65SBT2B-64AD from off to on.  
If Flash memory write error flag (RXnC) is still ON even after turning the power supply from off to on and performing the write to the flash memory, the possible cause is a failure of the AJ65SBT2B-64AD.  
Please consult your local Mitsubishi representative.

## 6.8 When Number of Offset/Gain Settings Excess Flag (RXnD) Turns on

---

The number of offset/gain setting times has exceeded the maximum of the guaranteed value (10,000 times).

If the offset/gain setting is configured after this flag turns on, the reflection of offset/gain value cannot be guaranteed. Replacement of the module is recommended.

APPENDIX

Appendix 1 External Dimensions

The following figures show the external dimensions of the AJ65SBT2B-64AD.

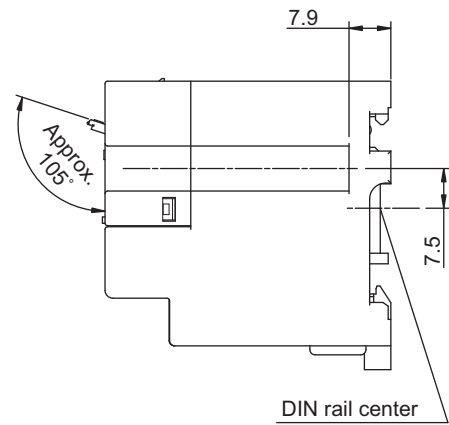
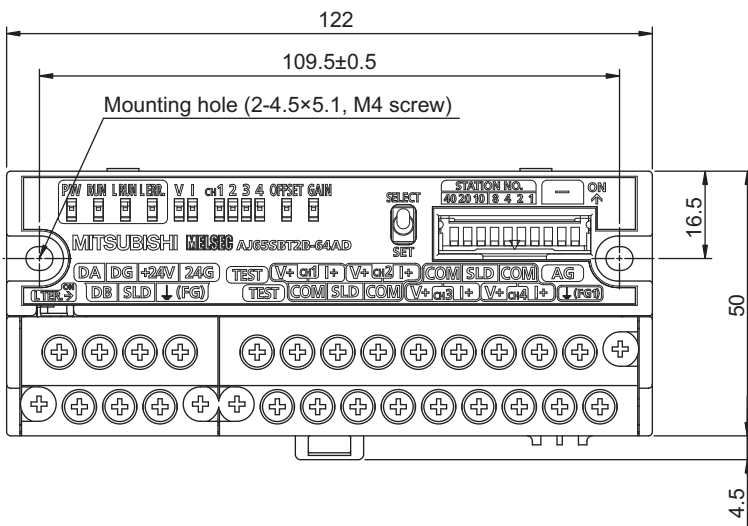
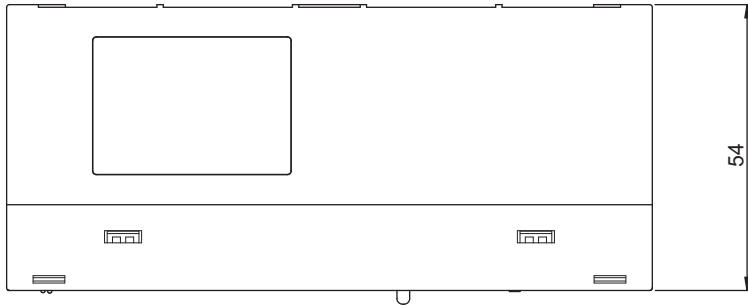

Unit: mm





# INDEX

<b>[A]</b>		Initial data setting request flag (RY(n+1)9).....	3-20
Absolute maximum input .....	3-2	Input range setting function .....	3-9,3-15
Accuracy .....	3-2,3-8	Intelligent device station .....	A-11
ACPU.....	A-11	I/O conversion characteristics.....	3-3
A/D conversion enable/disable function .....	3-9,3-10		
<b>[C]</b>		<b>[L]</b>	
CC-Link dedicated cable .....	4-9	L ERR. LED .....	4-5
CH□ Average processing setting		L RUN LED .....	4-5
(RWwm to RWwm+3).....	3-11	L TER. switch.....	4-6
CH□ A/D conversion completion flag		LCPU .....	A-11
(RXn0 to RXn3) .....	3-17	List of remote I/O signals .....	3-16
CH□ A/D conversion enable/disable setting		List of remote register assignments.....	3-21
(RYn0 to RYn3) .....	3-10,3-19	Local station.....	A-11
CH□ Digital output value (RWrn to RWrn+3).....	3-21		
CH□ Input range setting (RYn4 to RYnF)...	3-15,3-19	<b>[M]</b>	
Conversion cycle .....	3-12	Maintenance and inspection .....	4-14
Conversion method		Master module .....	A-11
Count average processing .....	3-12	Master station .....	A-11
Moving average processing .....	3-14	Module mounting direction.....	4-8
Sampling processing.....	3-12		
Time average processing.....	3-13	<b>[N]</b>	
Conversion speed.....	3-2,3-8	Number of analog input points.....	3-2
Current input characteristics .....	3-6	Number of offset/gain settings excess flag	
		(RXnD).....	3-17,6-7
<b>[D]</b>			
DIN rail.....	3-3,4-3	<b>[O]</b>	
DIN rail hook.....	4-6	Offset value.....	3-3
		Offset/gain adjustment LED .....	4-5
<b>[E]</b>		Offset/gain setting.....	3-9,4-12
Error flag (RX(n+1)A).....	3-19	Operation status indicator LED .....	4-5
Error reset request flag (RY(n+1)A).....	3-20		
External dimensions .....	App-1	<b>[P]</b>	
External power supply .....	3-3	Performance specifications.....	3-2
		Program example	
<b>[F]</b>		When using the QCPU (Q mode).....	5-4
Flash memory write error flag (RXnC).....	3-17,6-7	When using the LCPU.....	5-9
		When using the QnACPU .....	5-12
<b>[G]</b>		When using the ACPU/QCPU (A mode)	
Gain value .....	3-3	(dedicated instructions).....	5-17
General specifications .....	3-1	When using the ACPU/QCPU (A mode)	
GX Developer .....	A-11	(FROM/TO instructions) .....	5-21
GX Works2 .....	A-11	PW LED .....	4-5
<b>[H]</b>		<b>[Q]</b>	
Hardware error flag (RXnA).....	3-17,6-7	QCPU (A mode).....	A-11
		QCPU (Q mode) .....	A-11
<b>[I]</b>		QnACPU .....	A-11
Initial data processing completion flag			
(RY(n+1)8).....	3-20	<b>[R]</b>	
Initial data processing request flag		Remote device station .....	A-11
(RX(n+1)8).....	3-18	Remote I/O station.....	A-11
Initial data setting completion flag (RX(n+1)9).....	3-18	Remote ready (RX(n+1)B).....	3-19
		Remote station.....	A-11

Resolution.....	3-2
RLPA .....	2-2
RRPA.....	2-2
RUN LED.....	4-5
RWr .....	A-12
RWw .....	A-11
RX.....	A-11
RY.....	A-11

**[S]**

Sampling processing/average processing specification.....	3-11
SB.....	A-11
SELECT/SET switch.....	4-5
Station number setting.....	4-8
Station number setting switch.....	4-6
SW.....	A-11

**[T]**

Terminal block for analog input signal .....	4-6
Terminal block for transmission and module power supply lines.....	4-6
Terminating resistor.....	3-2,4-9
Test mode flag (RXnF).....	3-17
Tightening torque range .....	4-3
Transmission speed auto-tracking function .....	3-9,4-7
Troubleshooting.....	6-1

**[U]**

User range read error flag (RXnB) .....	3-17,6-7
---	----------

**[V]**

Voltage input characteristics.....	3-4
------------------------------------	-----

**[W]**

Weight .....	3-3
--------------	-----

# WARRANTY

Please confirm the following product warranty details before using this product.

## **1. Gratis Warranty Term and Gratis Warranty Range**

If any faults or defects (hereinafter "Failure") found to be the responsibility of Mitsubishi occurs during use of the product within the gratis warranty term, the product shall be repaired at no cost via the sales representative or Mitsubishi Service Company.

However, if repairs are required onsite at domestic or overseas location, expenses to send an engineer will be solely at the customer's discretion. Mitsubishi shall not be held responsible for any re-commissioning, maintenance, or testing on-site that involves replacement of the failed module.

[Gratis Warranty Term]

The gratis warranty term of the product shall be for one year after the date of purchase or delivery to a designated place.

Note that after manufacture and shipment from Mitsubishi, the maximum distribution period shall be six (6) months, and the longest gratis warranty term after manufacturing shall be eighteen (18) months. The gratis warranty term of repair parts shall not exceed the gratis warranty term before repairs.

[Gratis Warranty Range]

- (1) The range shall be limited to normal use within the usage state, usage methods and usage environment, etc., which follow the conditions and precautions, etc., given in the instruction manual, user's manual and caution labels on the product.
- (2) Even within the gratis warranty term, repairs shall be charged for in the following cases.
  1. Failure occurring from inappropriate storage or handling, carelessness or negligence by the user. Failure caused by the user's hardware or software design.
  2. Failure caused by unapproved modifications, etc., to the product by the user.
  3. When the Mitsubishi product is assembled into a user's device, Failure that could have been avoided if functions or structures, judged as necessary in the legal safety measures the user's device is subject to or as necessary by industry standards, had been provided.
  4. Failure that could have been avoided if consumable parts (battery, backlight, fuse, etc.) designated in the instruction manual had been correctly serviced or replaced.
  5. Failure caused by external irresistible forces such as fires or abnormal voltages, and Failure caused by force majeure such as earthquakes, lightning, wind and water damage.
  6. Failure caused by reasons unpredictable by scientific technology standards at time of shipment from Mitsubishi.
  7. Any other failure found not to be the responsibility of Mitsubishi or that admitted not to be so by the user.

## **2. Onerous repair term after discontinuation of production**

- (1) Mitsubishi shall accept onerous product repairs for seven (7) years after production of the product is discontinued.

Discontinuation of production shall be notified with Mitsubishi Technical Bulletins, etc.
- (2) Product supply (including repair parts) is not available after production is discontinued.

## **3. Overseas service**

Overseas, repairs shall be accepted by Mitsubishi's local overseas FA Center. Note that the repair conditions at each FA Center may differ.

## **4. Exclusion of loss in opportunity and secondary loss from warranty liability**

Regardless of the gratis warranty term, Mitsubishi shall not be liable for compensation of damages caused by any cause found not to be the responsibility of Mitsubishi, loss in opportunity, lost profits incurred to the user by Failures of Mitsubishi products, special damages and secondary damages whether foreseeable or not, compensation for accidents, and compensation for damages to products other than Mitsubishi products, replacement by the user, maintenance of on-site equipment, start-up test run and other tasks.

## **5. Changes in product specifications**

The specifications given in the catalogs, manuals or technical documents are subject to change without prior notice.



SH(NA)-080979ENG-B(1410)MEE

MODEL: AJ65SBT2B64AD-U-SY-E

MODEL CODE: 13JZ57

## **MITSUBISHI ELECTRIC CORPORATION**

HEAD OFFICE : TOKYO BUILDING, 2-7-3 MARUNOUCHI, CHIYODA-KU, TOKYO 100-8310, JAPAN  
NAGOYA WORKS : 1-14, YADA-MINAMI 5-CHOME, HIGASHI-KU, NAGOYA, JAPAN

When exported from Japan, this manual does not require application to the  
Ministry of Economy, Trade and Industry for service transaction permission.

Specifications subject to change without notice.