

# AJ65VBTC32-32DT 形 CC-Link システム小形タイプリモート I/O ユニットのユーザーズマニュアル AJ65VBTC32-32DT CC-Link System Compact Type Remote I/O Module User's Manual

## ● 安全上のご注意 ● (ご使用前に必ずお読みください)

本製品のご使用に際しては、本マニュアルをよくお読みいただくと共に、安全に対して十分に注意を払って、正しい取扱いをしていただくようお願いいたします。

なお、この注意事項は本製品に関するもののみについて記載したものです。シーケンサシステムとしての安全上のご注意に関しては、CPUユニットのユーザーズマニュアルを参照してください。

この●安全上のご注意●では、安全注意事項のランクを「危険」、「注意」として区分してあります。

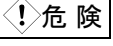
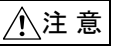
 <b>危険</b>	取扱いを誤った場合に、危険な状況が起こりえて、死亡または重傷を受ける可能性が想定される場合。
 <b>注意</b>	取扱いを誤った場合に、危険な状況が起こりえて、中程度の傷害や軽傷を受ける可能性が想定される場合および物的損害だけの発生が想定される場合。

なお、△注意に記載した事項でも、状況によっては重大な結果に結びつく可能性があります。

いずれも重要な内容を記載していますので必ず守ってください。本マニュアルは必要なときに読めるように大切に保管すると共に、必ず最終ユーザまでお届けいただくようお願いいたします。

### 【設計上の注意事項】

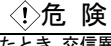
 <b>危険</b>	<ul style="list-style-type: none"> <li>データリンクが通信異常になったとき、通信異常時は次のような状態になります。通信状態情報を使って、システムが安全側に働くようにシーケンスプログラム上でインタロック回路を構成してください。誤出力、誤動作により事故の恐れがあります。                     <ol style="list-style-type: none"> <li>リモートI/O局からの入力、全点OFFします。</li> <li>リモートI/O局からの出力、全点OFFします。</li> </ol> </li> <li>リモートI/Oユニットの故障によっては、入出力がON状態またはOFF状態になることがあります。重大な事故につながるような入出力信号については、外部で監視する回路を設けてください。</li> </ul>
---	--

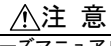
 <b>注意</b>	<ul style="list-style-type: none"> <li>ユニットは、CPUユニットユーザーズマニュアル記載の一般仕様の環境で使用してください。一般仕様の範囲以外の環境で使用すると、感電、火災、誤動作、製品の損傷あるいは劣化の原因になります。</li> <li>制御線や通信ケーブルは、主回路や動力線などと束線したり、近接したりしないでください。100mm以上を目安として離してください。ノイズにより、誤動作の原因になります。</li> </ul>
---	--

### 【取付け上の注意事項】

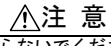
 <b>注意</b>	<ul style="list-style-type: none"> <li>ユニットの導電部分には直接触らないでください。ユニットの誤動作、故障の原因になります。</li> <li>ユニットは、DINレールなどにて、確実に固定してください。ユニットを確実に固定しないと、落下、誤動作の原因になります。</li> <li>各接続ケーブルのコネクタは装着部に確実に装着してください。接触不良による誤動作の原因になります。</li> </ul>
---	--

### 【配線上の注意事項】

 <b>危険</b>	<ul style="list-style-type: none"> <li>配線作業は、必ずシステムで使用している外部供給電源を全相遮断してから行ってください。全相遮断しないと、感電あるいは製品の損傷の恐れがあります。</li> </ul>
---	---

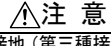
 <b>注意</b>	<ul style="list-style-type: none"> <li>FG端子はシーケンサ専用のD種接地(第三種接地)以上で必ず接地を行ってください。感電、誤動作の恐れがあります。</li> <li>ユニットの配線は、製品の定格電圧および端子配列を確認した上で正しく行ってください。定格と異なった電源を接続したり、誤配線すると、火災、故障の原因になります。</li> <li>ユニット内に、切粉や配線クズなどの異物が入らないように注意してください。火災、故障、誤動作の原因になります。</li> <li>ユニットに接続する電線やケーブルは、必ずダクトに納めるまたはクランプによる固定処理を行ってください。ケーブルをダクトに納めなかったり、クランプによる固定処理をしていない場合、ケーブルの破損、ケーブルの接続不良による誤動作の原因となります。</li> <li>制御線と通信ケーブルは束線したり、近接したりしないでください。ノイズにより、誤動作の原因になります。</li> <li>ユニットに接続された通信ケーブルや電源ケーブルを取り外すときは、ケーブル部分を手に持って引っ張らないでください。コネクタ付きのケーブルは、ユニットに接続している部分のコネクタを手で持って取り外してください。コネクタなしのケーブルは、ユニットに接続している部分のネジを緩めてから取り外してください。ユニットに接続された状態でケーブルを引っ張ると、ユニットやケーブルの破損、ケーブルの接続不良による誤動作の原因となります。</li> </ul>
---	---

### 【立上げ・保守時の注意事項】

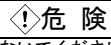
 <b>危険</b>	<ul style="list-style-type: none"> <li>通電中に端子やコネクタに触れないでください。感電の原因になります。</li> <li>清掃は、必ずシステムで使用している外部供給電源を全相遮断してから行ってください。全相遮断しないと、ユニットの故障や誤動作の原因になります。</li> </ul>
---	--

## ● SAFETY PRECAUTIONS ● (Read these precautions before using.)

When using this equipment, thoroughly read this manual. Also pay careful attention to safety and handle the module properly.

These precautions apply only to this equipment. Refer to the CPU module user's manual for a description of the PC system safety precautions.

These ●SAFETY PRECAUTIONS● classify the safety precautions into two categories: "DANGER" and "CAUTION".

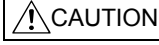
 <b>DANGER</b>	Procedures which may lead to a dangerous condition and cause death or serious injury if not carried out properly.
 <b>CAUTION</b>	Procedures which may lead to a dangerous condition and cause superficial to medium injury, or physical damage only, if not carried out properly.

Depending on circumstances, procedures indicated by △ CAUTION may also result in serious results.

In any case, it is important to follow the directions for usage.

Store this manual in a safe place so that you can take it out and read it whenever necessary. Always forward it to the end user.

(0706) MEE

### 【DESIGN PRECAUTIONS】

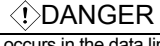
 <b>DANGER</b>	<ul style="list-style-type: none"> <li>When a communication error occurs in the data link, the communication error station will be in the following condition. Configure an interlocking circuit in a sequence program using the communication status information so that the safety of the overall system is always maintained. Accident may occur due to output error or malfunction.                     <ol style="list-style-type: none"> <li>Input points from remote I/O station will be all switched off.</li> <li>Output points from remote I/O station will be all switched off.</li> </ol> </li> <li>Input/output could be switched on or off when a problem occurs in the remote I/O modules. So build an external monitoring circuit that will monitor any I/O signals that could cause a serious accident.</li> </ul>
---	---

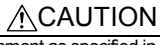
 <b>CAUTION</b>	<ul style="list-style-type: none"> <li>Use each module in an environment as specified in the "general specification" in the CPU module user's manual. Usage of the module outside the general specification range may cause electric shock, fire, malfunction, product damage or deterioration.</li> <li>Do not have control cables and communication cables bundled with or placed near by the main circuit and/or power cables. Wire those cables at least 100 mm (3.94 inch) away from the main circuit and/or power cables. It may cause malfunction due to noise interference.</li> </ul>
--	--

### 【INSTALLATION PRECAUTIONS】

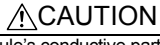
 <b>CAUTION</b>	<ul style="list-style-type: none"> <li>Do not directly touch the module's conductive parts. Doing so could cause malfunction or trouble in the module.</li> <li>Use a DIN rail or similar to securely fix the module. If the module is not securely fixed, it may fall off or cause malfunction.</li> <li>Correctly connect the cable connectors to the loading positions. A poor connection could result in erroneous operation.</li> </ul>
--	--

### 【WIRING PRECAUTIONS】

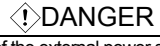
 <b>DANGER</b>	<ul style="list-style-type: none"> <li>Be sure to shut off all phases of the external power supply used by the system before wiring. Failure to do so may result in an electric shock or damage of the product.</li> </ul>
---	--

 <b>CAUTION</b>	<ul style="list-style-type: none"> <li>Always ground the FG terminal. There is a risk of electric shock or malfunction.</li> <li>Perform correct wiring for the module according to the product's rated voltage and terminal arrangement. Connecting to a power supply different from rating or miss-wiring may cause fire and/or product failure.</li> <li>Make sure foreign objects do not get inside the module, such as dirt and wire chips. It may cause fire, product failure or malfunction.</li> <li>Be sure to fix the wires or cables by ducts or clamps when connecting them to the module. Failure to do so may cause damage of the module or the cables due to accidental pull or unintentional shifting of the cables, or malfunctions due to poor contact of the cable.</li> <li>Do not install the control lines together with the communication cables, or bring them close to each other. Failure to do so may cause malfunctions due to noise.</li> <li>Do not pull the cable part by hand when removing a communication cable and power supply cable from a module. For a cable with connector, remove it while holding the connector by hand. For a cable with no connector, loosen the screw securing the cable to the module and then remove it. Pulling a cable with connected to the module may damage the module or cable, or result in malfunction due to cable poor connection.</li> </ul>
--	--

### 【STARTING AND MAINTENANCE PRECAUTIONS】

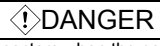
 <b>DANGER</b>	<ul style="list-style-type: none"> <li>Do not touch terminals or connectors when the power is on. Doing so could cause an electric shock.</li> <li>Switch off all phases of the externally supplied power used in the system when cleaning the module. Not doing so could result in electric shock.</li> </ul>
---	--

⚠注意	
● ユニットの分解、改造はしないでください。故障、誤動作、ケガ、火災の原因になります。	
● ユニットの落下させたり、強い衝撃を与えないでください。ユニットの破損の原因になります。	
● ユニットの盤への取付け・取外しは必ずシステムで使用している外部供給電源を全相遮断してから行ってください。全相遮断しないと、ユニットの故障や誤動作の原因になります。	
● ユニットの触れる前には、必ず接地された金属などに触れて、人体などに帯電している静電気を放電してください。静電気を放電しないと、ユニットの故障や誤動作の原因になります。	

【廃棄時の注意事項】

⚠注意	
● 製品を廃棄するときは、産業廃棄物として扱ってください。	

1. 仕様

項目	内容		
入力部	入力点数	16点	
	絶縁方式	フォトカプラ絶縁	
	定格入力電圧	DC24V	
	定格入力電流	約5mA	
	使用電圧範囲	DC19.2~26.4V (リップル率5%以内)	
	最大同時入力点数	100%	
	ON電圧/ON電流	14V以上/3.5mA以上	
	OFF電圧/OFF電流	6V以下/1.7mA以下	
	入力抵抗	約4.7kΩ	
	応答時間	OFF→ON 1.5ms以下 (DC24V時) ON→OFF 1.5ms以下 (DC24V時)	
入力形式	プラスコモン (シンクタイプ)		
出力部	出力点数	16点	
	絶縁方式	フォトカプラ絶縁	
	定格負荷電圧	DC24V	
	使用負荷電圧範囲	DC19.2~26.4V (リップル率5%以内)	
	最大負荷電流	0.1A/1点 1.6A/1コモン	
	最大突入電流	0.7A 10ms以下	
	OFF時漏洩電流	0.1mA以下	
	ON時最大電圧降下	0.1V以下 (TYP.) 0.1A, 0.2V以下 (MAX.) 0.1A	
	出力形式	シンクタイプ	
	保護機能	過負荷保護機能、過電圧保護機能、過熱保護機能	
応答時間	OFF→ON	1ms以下	
	ON→OFF	1ms以下 (抵抗負荷)	
出力部外部供給電源	電圧	DC19.2~26.4V (リップル率5%以内)	
	電流	10mA以下 (DC24V、全点ON時) 外部負荷電流は含まず	
サージキラー	ツェナーダイオード		
コモン方式	32点1コモン (センサコネクタ (e-CON) 形 3線式: 入力, センサコネクタ (e-CON) 形 2線式: 出力)		
占有局数	1局32点割付け (32点使用)		
I/Oユニット電源	電圧	DC20.4~26.4V (リップル率5%以内)	
	電流	45mA以下 (DC24V、全点ON時)	
ノイズ耐量	DCタイプのノイズ電圧500Vp-p、ノイズ幅1μs、ノイズ周波数25~60Hzのノイズシミュレータによる		
耐電圧	DC外部端子一括アース間AC500V 1分間		
絶縁抵抗	DC外部端子一括アース間DC500V絶縁抵抗計にて10MΩ以上		
保護等級	IP1XB		
質量	0.16kg		
外部接続方式 *1	通信部	通信用ワンタッチコネクタ [伝送回路] (5ピン・圧接タイプ、コネクタ用プラグは別売: A6CON-L5P) <オプション> 通信用オンラインコネクタ: A6CON-LJ5P	
	電源部	電源・FG用ワンタッチコネクタ [I/Oユニット電源、負荷電源、入出力部外部供給 電源、FG] (5ピン・圧接タイプ、コネクタ用プラグは別売: A6CON-PW5P、A6CON-PW5P-SOD) <オプション> 電源用オンラインコネクタ: A6CON-PWJ5P	
	入出力部	センサコネクタ (e-CON) [I/O信号] (4ピン・圧接タイプ、コネクタ用プラグは別売)	
適用DINレール	TH35-7.5Fe、TH35-7.5A1 (JIS C 2812に準拠)		
適合電線サイズ	通信用コネクタ	適合ケーブル: FANC-110SBH、CS-110	
	電源・FG用コネクタ	0.66~0.98mm <sup>2</sup> (AWG#18) [φ2.2~3.0mm (A6CON-PW5P), φ2.0~2.3mm (A6CON-PW5P-SOD)] 素線径0.16mm以上 絶縁被覆材質: PVC (耐熱ビニル)	
	入出力部コネクタ	センサコネクタ (e-CON) コネクタ用プラグは別売 (適合電線サイズ: 0.08~0.5mm <sup>2</sup> 、使用するコネク タ用プラグにより異なる) CC-Linkシステム小形タイプリモートI/Oユニット ユーザーズマニュアル (詳細編) SH(名)3307参照	

\*1: 各コネクタの圧接方法は、CC-Linkシステム小形タイプリモートI/Oユニットユーザーズマニュアル (詳細編) SH(名)3307を参照してください。

⚠CAUTION	
● Never try to disassemble or modify module. It may cause product failure, malfunction, fire or cause injury.	
● Do not drop or apply any strong impact to the module. Doing so may damage the module.	
● Completely turn off the externally supplied power used in the system before mounting or removing the module to/from the panel. Not doing so could result in damage to the product.	
● Always make sure to touch the grounded metal to discharge the electricity charged in the body, etc., before touching the module. Failure to do so may cause a failure or malfunctions of the module.	

【DISPOSAL PRECAUTIONS】

⚠CAUTION	
● When disposing of this product, treat it as industrial waste.	

1. Specification

Item	Description		
Input	Number of input points	16 points	
	Isolation method	Photocoupler	
	Rated input voltage	24 V DC	
	Rated input current	Approx. 5 mA	
	Operating voltage range	19.2 to 26.4 V DC (ripple ratio: within 5%)	
	Max. simultaneous ON input	100%	
	ON voltage/ON current	14 V or higher/3.5 mA or higher	
	OFF voltage/OFF current	6 V or lower/1.7 mA or lower	
	Input resistance	Approx. 4.7 kΩ	
	Response time	OFF→ON	1.5 ms or lower (when 24 V DC)
ON→OFF		1.5 ms or lower (when 24 V DC)	
Input form	Positive common (sink type)		
Output	Number of output points	16 points	
	Isolation method	Photocoupler	
	Rated load voltage	24 V DC	
	Operating load voltage range	19.2 to 26.4 V DC (ripple ratio: within 5%)	
	Max. load current	0.1 A/point 1.6 A/common	
	Max. inrush current	0.7 A 10 ms or lower	
	Leakage current at OFF	0.1 mA or lower	
	Max. voltage drop at ON	0.1 V or lower (TYP.) 0.1 A, 0.2 V or lower (MAX.) 0.1 A	
	Output form	Sink type	
	Protection function	Overload protection function, overvoltage protection function and overheat protection function	
Response time	OFF→ON	1 ms or lower	
	ON→OFF	1 ms or lower (resistive load)	
External power supply part	Voltage	19.2 to 26.4 V DC (ripple ratio: 5%)	
	Current	10 mA or lower (when 24 V DC, all points ON) Not including external load current	
Surge suppression	Zener diode		
Wiring method for common	32 points/common (Sensor connector (e-CON) 3-wire type: Input Sensor connector (e-CON) 2-wire type: Output)		
Number of stations occupied	1 station 32 points assignment (use 32 points)		
I/O module power supply	Voltage	20.4 to 26.4 V DC (ripple ratio: within 5%)	
	Current	45 mA or lower (when 24 V DC, all points ON)	
Noise durability	DC type noise voltage 500 Vp-p, noise width 1 μs, noise frequency 25 to 60 Hz (noise simulator condition)		
Withstand voltage	500 V AC for 1 minute between all DC external terminals and ground		
Insulation resistance	10 MΩ or higher, measured with a 500 V DC insulation resistance tester between all DC external terminals and ground		
Protection of degree	IP1XB		
Weight	0.16 kg		
External wiring system *1	Communication part	One-touch connector for communication [Transmission circuit] (5 pins pressure welding type) The plug for the connector is sold separately: A6CON-L5P < Option > Online connector for communication: A6CON-LJ5P	
	Power supply part	One-touch connector for power supply and FG [I/O module power supply, Load power supply, External power supply for I/O and FG] (5 pins pressure welding type) The plug for the connector is sold separately: A6CON-PW5P, A6CON-PW5P-SOD < Option > Online connector for power supply: A6CON-PWJ5P	
	I/O part	Sensor connector (e-CON) [I/O signal] (4 pins pressure welding type) The plug for the connector is sold separately	
Applicable DIN rail	TH35-7.5Fe, TH35-7.5A1 (conforming to IEC 60715)		
Applicable wire size	Connector for communication	Applicable cable: FANC-110SBH, CS-110	
	Connector for power supply and FG	0.66 to 0.98 mm <sup>2</sup> (18AWG) [φ2.2 to 3.0 mm (A6CON-PW5P), φ2.0 to 2.3 mm (A6CON-PW5P-SOD)] Outer insulation layer material: PVC (Heat-resistant vinyl)	
	Connector for I/O part	Sensor connector (e-CON) Plug for connector is sold separately (Applicable wire size: 0.08 to 0.5 mm <sup>2</sup> , depending on the plug for connector) Refer to CC-Link System Compact Type Remote I/O Module User's Manual SH(NA)4007.	

\*1: For crimping each connector, refer to CC-Link System Compact Type Remote I/O Module User's Manual (SH(NA)4007).

外部接続 (External connection)

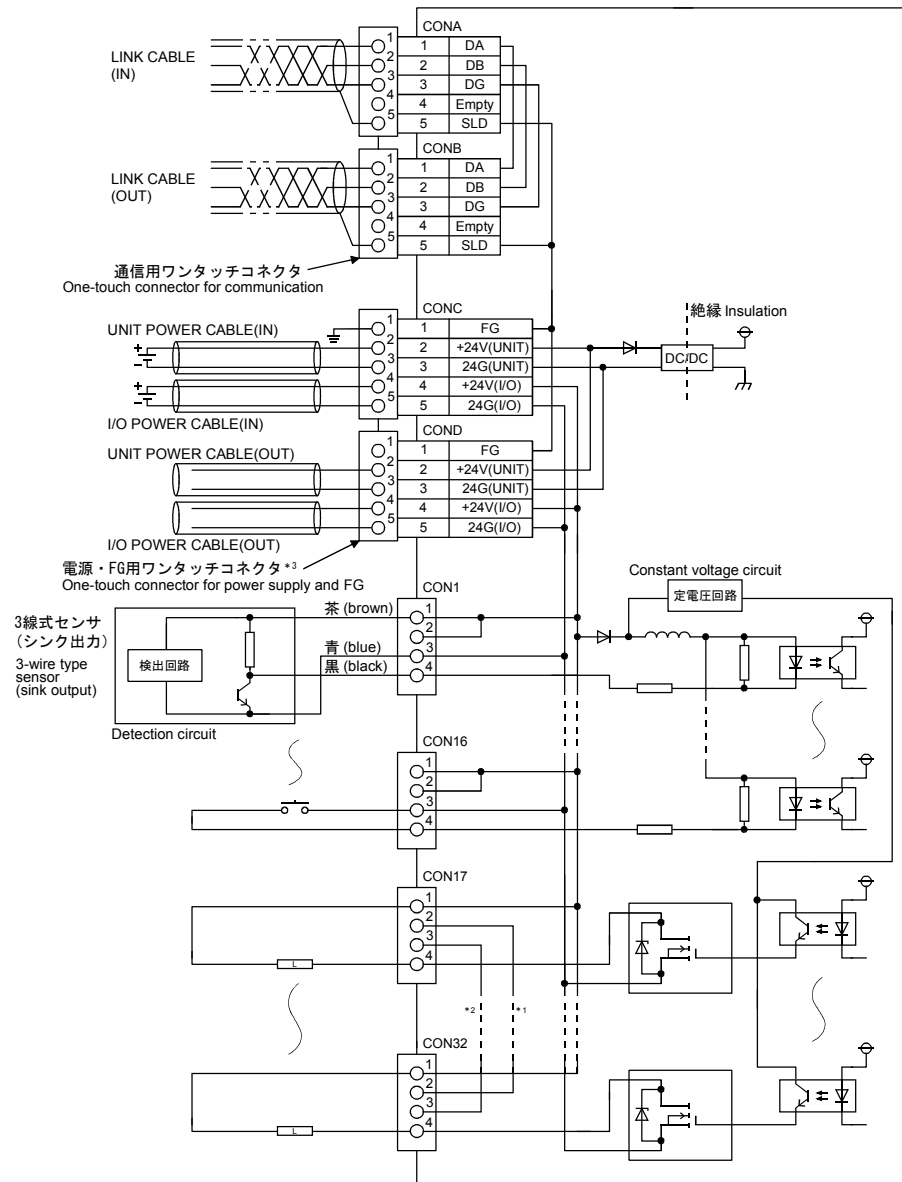

- \* 1 : CON17-32 の 2 ピンは内部で接続されているため使用できません。  
No.2 pins of CON17 to 32 are internally connected and unusable.
- \* 2 : CON17-32 の 3 ピンは内部で接続されているため使用できません。  
No.3 pins of CON17 to 32 are internally connected and unusable.
- \* 3 : 電源・FG用コネクタのアキには必ず無配線のコネクタを装着してください。  
The connector in non-divided line should be installed empty of connector for the power supply and FG.

端子配列 Pin arrangement

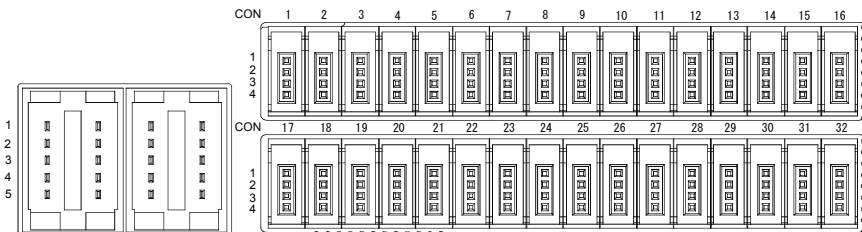

ユニットの正面から見た場合  
A module view from the top

ピン番号 Pin No.	信号名 Signal name	ピン番号 Pin No.	信号名 Signal name	
CON A,B	1	1	(FG)	
	2	2	+24V (UNIT)	
	3	3	24G (UNIT)	
	4	4	+24V(I/O)	
	5	5	24G(I/O)	
CON C,D	1	1	(FG)	
	2	2	+24V (UNIT)	
	3	3	24G (UNIT)	
	4	4	+24V(I/O)	
	5	5	24G(I/O)	
ピン番号 Pin No.	信号名 Signal name	ピン番号 Pin No.	信号名 Signal name	
CON1 (X0)	1	CON17 (Y10)	1	+24V
	2	2	Empty *1	
	3	3	Empty *2	
	4	4	Y10	
CON2 (X1)	1	CON18 (Y11)	1	+24V
	2	2	Empty *1	
	3	3	Empty *2	
	4	4	Y11	
CON3 (X2)	1	CON19 (Y12)	1	+24V
	2	2	Empty *1	
	3	3	Empty *2	
	4	4	Y12	
CON4 (X3)	1	CON20 (Y13)	1	+24V
	2	2	Empty *1	
	3	3	Empty *2	
	4	4	Y13	
CON5 (X4)	1	CON21 (Y14)	1	+24V
	2	2	Empty *1	
	3	3	Empty *2	
	4	4	Y14	
CON6 (X5)	1	CON22 (Y15)	1	+24V
	2	2	Empty *1	
	3	3	Empty *2	
	4	4	Y15	
CON7 (X6)	1	CON23 (Y16)	1	+24V
	2	2	Empty *1	
	3	3	Empty *2	
	4	4	Y16	
CON8 (X7)	1	CON24 (Y17)	1	+24V
	2	2	Empty *1	
	3	3	Empty *2	
	4	4	Y17	
CON9 (X8)	1	CON25 (Y18)	1	+24V
	2	2	Empty *1	
	3	3	Empty *2	
	4	4	Y18	
CON10 (X9)	1	CON26 (Y19)	1	+24V
	2	2	Empty *1	
	3	3	Empty *2	
	4	4	Y19	
CON11 (XA)	1	CON27 (Y1A)	1	+24V
	2	2	Empty *1	
	3	3	Empty *2	
	4	4	Y1A	
CON12 (XB)	1	CON28 (Y1B)	1	+24V
	2	2	Empty *1	
	3	3	Empty *2	
	4	4	Y1B	
CON13 (XC)	1	CON29 (Y1C)	1	+24V
	2	2	Empty *1	
	3	3	Empty *2	
	4	4	Y1C	
CON14 (XD)	1	CON30 (Y1D)	1	+24V
	2	2	Empty *1	
	3	3	Empty *2	
	4	4	Y1D	
CON15 (XE)	1	CON31 (Y1E)	1	+24V
	2	2	Empty *1	
	3	3	Empty *2	
	4	4	Y1E	
CON16 (XF)	1	CON32 (Y1F)	1	+24V
	2	2	Empty *1	
	3	3	Empty *2	
	4	4	Y1F	

## 2. 各部の名称と設定

## 2. Part Names and Settings

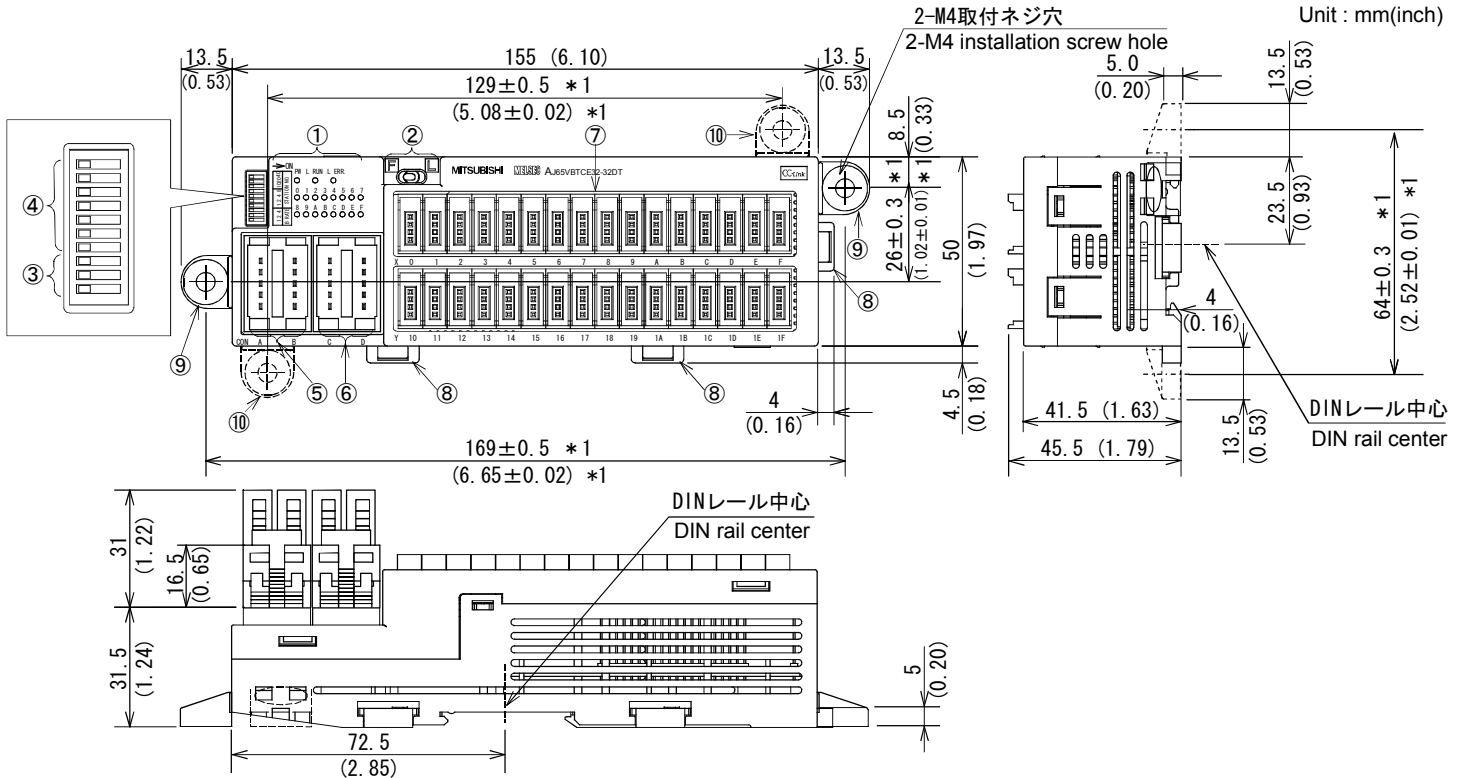

\*1: 取付ネジ加工寸法 (取付ピッチ)

\*1: Adjust the screws to ensure this length. (Mounting pitch)

No.	名称	内容																																	
①	動作表示 LED	<p>確認内容</p> <p>PW 点灯: 電源ON 消灯: 電源OFF</p> <p>L RUN 点灯: 交信正常時 消灯: 交信断時 (タイムオーバーエラー)</p> <p>L ERR. 点灯: 交信エラー時 一定間隔で点滅: 通電中に局番設定 / 伝送速度設定スイッチの設定を変更したとき 不定間隔で点滅: 終端抵抗の設定が違っているとき ユニット, CC-Link専用ケーブルがノイズの影響を受けているとき。 消灯: 交信正常時</p> <p>X0~F 点灯: 入出力ON Y10~1F 消灯: 入出力OFF</p>																																	
②	入出力表示 切換え スイッチ	<p>スイッチを“F”(first-half)に設定すると、前半16点のON/OFF状態を表示します。</p> <p>スイッチを“L”(latter-half)に設定すると、後半16点のON/OFF状態を表示します。</p>																																	
③	伝送速度設定 スイッチ	<table border="1"> <thead> <tr> <th rowspan="2">設定値</th> <th colspan="3">設定スイッチ状態</th> <th rowspan="2">伝送速度</th> </tr> <tr> <th>4</th> <th>2</th> <th>1</th> </tr> </thead> <tbody> <tr> <td>0</td> <td>OFF</td> <td>OFF</td> <td>OFF</td> <td>156 kbps</td> </tr> <tr> <td>1</td> <td>OFF</td> <td>OFF</td> <td>ON</td> <td>625 kbps</td> </tr> <tr> <td>2</td> <td>OFF</td> <td>ON</td> <td>OFF</td> <td>2.5 Mbps</td> </tr> <tr> <td>3</td> <td>OFF</td> <td>ON</td> <td>ON</td> <td>5.0 Mbps</td> </tr> <tr> <td>4</td> <td>ON</td> <td>OFF</td> <td>OFF</td> <td>10 Mbps</td> </tr> </tbody> </table> <p>伝送速度は必ず上記の範囲で設定してください。</p>	設定値	設定スイッチ状態			伝送速度	4	2	1	0	OFF	OFF	OFF	156 kbps	1	OFF	OFF	ON	625 kbps	2	OFF	ON	OFF	2.5 Mbps	3	OFF	ON	ON	5.0 Mbps	4	ON	OFF	OFF	10 Mbps
設定値	設定スイッチ状態			伝送速度																															
	4	2	1																																
0	OFF	OFF	OFF	156 kbps																															
1	OFF	OFF	ON	625 kbps																															
2	OFF	ON	OFF	2.5 Mbps																															
3	OFF	ON	ON	5.0 Mbps																															
4	ON	OFF	OFF	10 Mbps																															
④	局番設定 スイッチ	<p>STATION NO.の“10”, “20”, “40”で局番の10の位を設定します。</p> <p>STATION NO.の“1”, “2”, “4”, “8”で局番の1の位を設定します。</p> <p>局番は必ず1~64の範囲で設定してください。*2</p> <p>(例) 局番を“32”に設定するときは、下記のようにスイッチ設定を行います。</p> <table border="1"> <thead> <tr> <th rowspan="2">局番</th> <th colspan="4">十の位</th> <th colspan="4">一の位</th> </tr> <tr> <th>40</th> <th>20</th> <th>10</th> <th>8</th> <th>4</th> <th>2</th> <th>1</th> </tr> </thead> <tbody> <tr> <td>32</td> <td>OFF</td> <td>ON</td> <td>ON</td> <td>OFF</td> <td>OFF</td> <td>ON</td> <td>OFF</td> </tr> </tbody> </table>	局番	十の位				一の位				40	20	10	8	4	2	1	32	OFF	ON	ON	OFF	OFF	ON	OFF									
局番	十の位				一の位																														
	40	20	10	8	4	2	1																												
32	OFF	ON	ON	OFF	OFF	ON	OFF																												
⑤	通信用 コネクタ	通信ラインの接続用ワンタッチコネクタ。																																	
⑥	電源・FG用 コネクタ	ユニット電源ライン, I/O電源ライン, FGの接続用ワンタッチコネクタ。																																	
⑦	I/O用 コネクタ	入出力信号の接続用コネクタ。																																	
⑧	DINレール用 フック	ユニットをDINレールに取り付ける場合にDINレール用フックの中心線上を指でカチッと音がするまで押さえます。																																	
⑨	ネジ取付け用 固定具	ユニットを盤などに取り付ける場合に、ユニットに装着して使用します。(⑨と⑩の2通りの装着が可能です。)																																	
⑩	ネジ取付け用 固定具 (付属品)	ネジ取付け用固定具は、取り外すことが可能です。																																	

\*2: 局番は重複して設定できません。

No.	Item	Description																																	
①	Operating status LEDs	<p>Confirmation details</p> <p>PW ON: Power supply ON OFF: Power supply OFF</p> <p>L RUN ON: Normal communication OFF: Communication shut off (time expiration error)</p> <p>L ERR. ON: Communication data error Flash at regular intervals: Indicates that the station number setting or transmission speed setting switch position was changed while power is ON Flash at irregular intervals: When the setting of the terminal resistor is wrong; when the cable for the module or CC-Link is affected by noise OFF: Normal communication</p> <p>0 to F ON: Input/Output ON OFF: Input/Output OFF</p>																																	
②	I/O display switch	The ON/OFF status of the first 16 points is displayed when this switch is set to "F". The ON/OFF status of the remaining 16 points is displayed when this switch is set to "L".																																	
③	Transmission speed setting switch	<table border="1"> <thead> <tr> <th rowspan="2">Setting value</th> <th colspan="3">Setting switch status</th> <th rowspan="2">Transmission speed</th> </tr> <tr> <th>4</th> <th>2</th> <th>1</th> </tr> </thead> <tbody> <tr> <td>0</td> <td>OFF</td> <td>OFF</td> <td>OFF</td> <td>156 kbps</td> </tr> <tr> <td>1</td> <td>OFF</td> <td>OFF</td> <td>ON</td> <td>625 kbps</td> </tr> <tr> <td>2</td> <td>OFF</td> <td>ON</td> <td>OFF</td> <td>2.5 Mbps</td> </tr> <tr> <td>3</td> <td>OFF</td> <td>ON</td> <td>ON</td> <td>5.0 Mbps</td> </tr> <tr> <td>4</td> <td>ON</td> <td>OFF</td> <td>OFF</td> <td>10 Mbps</td> </tr> </tbody> </table> <p>Be sure to set the transmission speed within the above range.</p>	Setting value	Setting switch status			Transmission speed	4	2	1	0	OFF	OFF	OFF	156 kbps	1	OFF	OFF	ON	625 kbps	2	OFF	ON	OFF	2.5 Mbps	3	OFF	ON	ON	5.0 Mbps	4	ON	OFF	OFF	10 Mbps
Setting value	Setting switch status			Transmission speed																															
	4	2	1																																
0	OFF	OFF	OFF	156 kbps																															
1	OFF	OFF	ON	625 kbps																															
2	OFF	ON	OFF	2.5 Mbps																															
3	OFF	ON	ON	5.0 Mbps																															
4	ON	OFF	OFF	10 Mbps																															
④	Station number setting switch	<p>Select "10", "20" or "40" to set the tens place of the station number.</p> <p>Select "1", "2", "4" or "8" to set the ones place of the station number.</p> <p>Always set the station number within the range of 1 to 64. *2</p> <p>(Example) Set the switches as below when setting the station number to 32:</p> <table border="1"> <thead> <tr> <th rowspan="2">Station number</th> <th colspan="4">Tens place</th> <th colspan="4">Ones place</th> </tr> <tr> <th>40</th> <th>20</th> <th>10</th> <th>8</th> <th>4</th> <th>2</th> <th>1</th> </tr> </thead> <tbody> <tr> <td>32</td> <td>OFF</td> <td>ON</td> <td>ON</td> <td>OFF</td> <td>OFF</td> <td>ON</td> <td>OFF</td> </tr> </tbody> </table>	Station number	Tens place				Ones place				40	20	10	8	4	2	1	32	OFF	ON	ON	OFF	OFF	ON	OFF									
Station number	Tens place				Ones place																														
	40	20	10	8	4	2	1																												
32	OFF	ON	ON	OFF	OFF	ON	OFF																												
⑤	Connector for communication	One-touch connector for connection of communication line.																																	
⑥	Connector for power supply and FG	One-touch connector for unit power supply line, I/O power supply line, and FG.																																	
⑦	Connector for I/O	Connector for connection of I/O signal.																																	
⑧	Hook for DIN rail	When the module is installed to the DIN rail, push on the center line of the hook for DIN rail with a finger tip until a clicking sound is heard.																																	
⑨	Holding fixtures for screw installation	When mounting a module to a panel or similar, attach the fixtures to the module (in two positions of ⑨ and ⑩).																																	
⑩	Holding fixtures for screw installation (Accessory)	Holding fixtures for screw installation are removal.																																	

\*2: Duplicate station number cannot be set.

## 3. 同梱品 (付属品)

ネジ取付け用固定具 2個

## 3. Included parts (Accessory)

Holding fixtures for screw installation 2