

MITSUBISHI

Type A80BDE-J61BT13 CC-Link Interface Board

User's Manual (For SW3DNF-CCLINK)

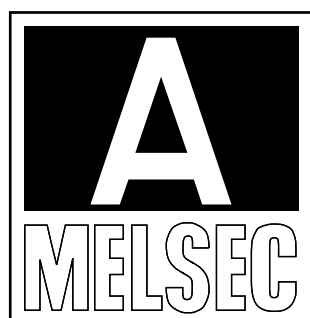
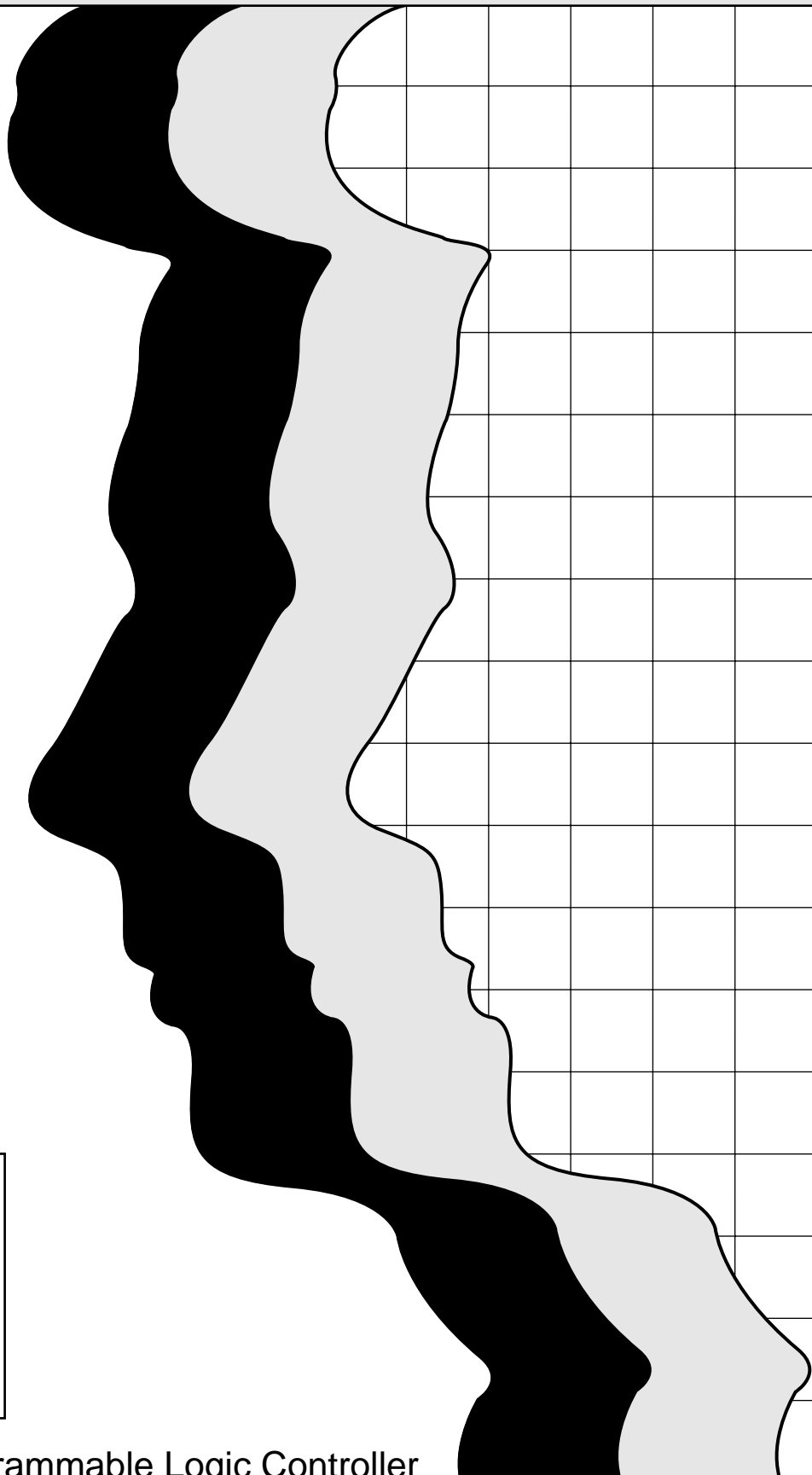

Mitsubishi Programmable Logic Controller

● SAFETY PRECAUTIONS ●

(Read these precautions before using.)

When using Mitsubishi equipment, thoroughly read this manual and the associated manuals introduced in this manual. Also pay careful attention to safety and handle the module properly.

These precautions apply only to Mitsubishi equipment. Refer to the CPU module user's manual for a description of the PC system safety precautions.

These ● SAFETY PRECAUTIONS ● classify the safety precautions into two categories: "DANGER" and "CAUTION".



Procedures which may lead to a dangerous condition and cause death or serious injury if not carried out properly.



Procedures which may lead to a dangerous condition and cause superficial to medium injury, or physical damage only, if not carried out properly.

Depending on circumstances, procedures indicated by  CAUTION may also be linked to serious results.

In any case, it is important to follow the directions for usage.

Store this manual in a safe place so that you can take it out and read it whenever necessary. Always forward it to the end user.

[DESIGN PRECAUTIONS]

DANGER

- When there is a communication error in the data link, the station where the communication is occurring changes to the following status.
Construct an interlock circuit in the sequence program so that the system will operate on the safety side using the communication status information.
There is the risk of an accident occurring due to output error or malfunctioning.
 - (1) All general purpose inputs from this I/F board (A80BDE-J61BT13) are turned off.
 - (2) All general purpose outputs from this I/F board are turned off.
- A failure in the I/F board may cause I/O to change to on status or off status.
Establish a circuit to be observed externally for those I/O signals that may threaten to cause serious accident.

CAUTION

- Do not bunch the control wires or communication cables with the main circuit or power wires, or install them close to each other.
They should be installed 100 mm (3.9 inch) or more from each other.
Not doing so could result in noise that would cause malfunction.

[INSTALLATION PRECAUTIONS]

CAUTION

- Use the I/F board in an environment as described in the general specifications listed in this operating manual. If the board is used in an environment outside the ranges described in the general specifications, it may result in an electric shock, fire, malfunctioning, damage to or deterioration of the product.
- Do not directly touch the conductive area of the I/F board. This will result in malfunctioning or failure of the I/F board.
- Fix the I/F board securely with the installation screws and tighten the installation screws within the specified torque range. If the screws are loose, this will lead to an error in operation. If the screws are tightened too much, this will damage the screws and cause a short.

[WIRING PRECAUTIONS]

DANGER

- Always turn off all external power before performing installation, wiring or other work. If all power is not turned off, there is a risk of electric shock, damage to the product, or malfunctioning.
- When turning on the power and operating the module after installation and wiring are completed, always attach the terminal cover that comes with the product. There is a risk of electric shock if the terminal cover is not attached.

[WIRING PRECAUTIONS]

CAUTION

- Always ground the FG terminal on the PC side using D type grounding (Class 3 grounding) or higher specifically for the PC. Otherwise, there is a risk of malfunctioning. If a malfunctioning occurs even when the PC unit is grounded, ground both the FG terminal for the PC unit and the SLD terminal for the I/F board.
- Tighten the terminal screws within the specified torque range. If the terminal screws are loose, this will lead to a short or malfunctioning. If the terminal screws are tightened too much, this will damage the screws and I/F board, causing a short or malfunctioning.
- Take care that foreign objects such as chips or wiring debris do not get inside the I/F board. This can result in fire, failure or malfunctioning.
- Always house the communication cable and power cable connected to the I/F board in a duct or secure it using clamps. If the cables are not housed in a duct or secured with clamps, the cable may dangle, move or be pulled inadvertently. This can cause damage to the I/F board or cable, or create a faulty contact with the cable which may lead to.
- When disconnecting the communication or power cable connected to the I/F board, do not grasp and pull the cable. First loosen the screws where the cable is connected to the I/F board and then remove the cable. If the cable is pulled while it is connected to the I/F board, this can cause damage to the I/F board or cable, or create a faulty contact with the cable and lead to malfunctioning.

[STARTING AND MAINTENANCE PRECAUTIONS]

DANGER

- Do not touch the terminal when the power is turned on.
This can cause malfunctioning.
- Always turn off all external power before doing any cleaning or re-tightening the terminal screws. If all power is not turned off, this can cause a failure or malfunctioning of the I/F board.
If the screws are loose, this can cause the terminal to drop, short or operate in error.
If the screws are tightened too much, this can damage the screws and I/F board, causing the terminal to drop, short or operate in error.

[STARTING AND MAINTENANCE PRECAUTIONS]

CAUTION

- Do not dismantle or rebuild the I/F board.
This will result in breakdowns, malfunctioning, injury or fire.
- Always turn off all external power before installing or removing the I/F board.
If all power is not turned off, this will result in failure of the I/F board or malfunctioning.

[DISPOSAL PRECAUTION]

CAUTION

- When disposing of this product, treat it as industrial waste.

Revisions

* The manual number is noted at the lower left of the back cover.

Print Date	*Manual Number	Revision
Sep. 1999	IB(NA)-0800036-A	First printing

This manual does not imply guarantee or implementation right for industrial ownership or implementation of other rights. Mitsubishi Electric Corporation is not responsible for industrial ownership problems caused by use of the contents of this manual.

Precautions when Using

(1) When using Windows NT 4.0

When using Windows NT 4.0, only a user with the Administrator privilege can install or use the board.

(2) Multi-thread communication

Multi-thread communication is not supported.

(3) Installation

Install the SW3DNF-CCLINK after uninstalling SW0DNF-CCLINK, SW1DNF-CCLINK and SW2DNF-CCLINK.

(4) Overwrite installation

When performing an overwrite installation, install in the same folder where the previous program is installed.

(5) Start menu

When the software package is uninstalled, items may remain in the start menu. In this case, reboot the computer.

(6) Software version of the CC-Link master and local modules

For the CC-Link master and local modules, use software version "N" or later. A module running software version "M" or earlier will not run properly.

(7) I/F board ROM version

When connecting to the QCPU (Q mode), be sure to use an I/F board whose ROM version is "W" or later.

The system will not operate correctly if an I/F board of "V" or older ROM version is used.

(8) Multiprocessor PC

Multiprocessor PCs cannot be used because they are not supported by the driver.

(9) Accessing the CN device for the FXCPU

CN devices for the FXCPU with numbers 200 or after cannot be accessed (read, write).

Introduction

Thank you for purchasing the A80BDE-J61BT13 Model CC-Link Interface Board.

Before using the equipment, please read this manual carefully to develop full familiarity with the functions and performance of the A80BDE-J61BT13 Model CC-Link Interface Board you have purchased, so as to ensure correct use.

Please forward a copy of this manual to the end user.

Table of Contents

SAFETY PRECAUTIONS	A- 1
Revisions	A- 4
Precautions when Using	A- 5
Table of Contents	A- 6
About This Manual	A- 9
How to Read the Manual	A-10
Abbreviations and General Terms Used in This Manual	A-11
Product Structure	A-12

1. OVERVIEW	1-1 to 1-2
--------------------	-------------------

1.1 Features.....	1- 1
1.2 Compatibility with Existing Software	1- 2

2. EMC COMMAND	2-1 to 2-6
-----------------------	-------------------

2.1 Requirements for EMC Command Compliance	2- 1
2.1.1 EMC commands	2- 1
2.1.2 Installation on the control panel	2- 2
2.1.3 Cable	2- 3
2.1.4 Noise filter (power supply line filter).....	2- 5

3. SYSTEM CONFIGURATION	3-1 to 3-4
--------------------------------	-------------------

3.1 System Configuration for A80BDE-J61BT13	3- 1
3.2 Applicable System	3- 2
3.3 Operating Environment	3- 3

4. SPECIFICATION	4-1 to 4-4
-------------------------	-------------------

4.1 General Specification	4- 1
4.2 Performance Specifications	4- 2
4.3 Total Extension Distance and Between-Station Distance in the CC-Link System	4- 3
4.4 Twisted Cable Specifications	4- 4
4.5 List of Functions.....	4- 4

5. PROCEDURE AND SETTINGS UP TO THE POINT OF OPERATION	5-1 to 5-6
---	-------------------

5.1 Procedure Up to the Point of Operation.....	5- 1
5.2 Installation.....	5- 2
5.2.1 Precautions when handling.....	5- 2
5.2.2 Installation environment.....	5- 3
5.2.3 How to remove the terminal block	5- 3
5.3 Name and Setting for Each Part	5- 4
5.4 Wiring.....	5- 5
5.4.1 Precautions when handling the twisted cable	5- 5
5.4.2 How to wire to each module.....	5- 6

6. INSTALLING AND UNINSTALLING SOFTWARE PACKAGES	6-1 to 6-8
---	-------------------

6.1	Installing and Uninstalling Software Packages for Windows 95/98/NT 4.0.....	6- 1
6.1.1	Installing software packages for Windows 95/98/NT 4.0.....	6- 1
6.1.2	Icons to be registered.....	6- 5
6.1.3	Uninstalling software packages for Windows 95/98/NT 4.0.....	6- 6

7. UTILITY OPERATION	7-1 to 7-28
-----------------------------	--------------------

7.1	Utility Common Operations.....	7- 1
7.1.1	Starting an utility.....	7- 1
7.1.2	Starting the device monitor utility.....	7- 1
7.1.3	Ending an utility.....	7- 2
7.1.4	Displaying the help screen.....	7- 3
7.1.5	Verifying the version.....	7- 4
7.2	CC-Link Utility Operation.....	7- 5
7.2.1	Operation procedure.....	7- 5
7.2.2	Card list screen operation.....	7- 6
7.2.3	Operations on Card Information screen.....	7- 7
7.2.4	Operations on Line Monitor (host) screen.....	7- 9
7.2.5	Operations on Line Monitor (other station) screen.....	7-10
7.2.6	Operations on Memory I/O Test screen.....	7-11
7.2.7	Operation of the test screen.....	7-12
7.3	Device Monitor Utility.....	7-13
7.3.1	Operation procedure.....	7-13
7.3.2	Setting as batch monitoring.....	7-14
7.3.3	Setting as 16 point register monitor.....	7-15
7.3.4	Setting the monitoring destination.....	7-16
7.3.5	Setting the device to monitor.....	7-17
7.3.6	Changing word device values.....	7-18
7.3.7	Changing word device values continuously.....	7-19
7.3.8	Tuning on/off a bit device.....	7-20
7.3.9	Switching the display form.....	7-20
7.3.10	About the Numerical Input pad.....	7-21
7.3.11	Other operations.....	7-22
7.4	Error Viewer.....	7-24
7.4.1	Screen description.....	7-24
7.4.2	Log menu.....	7-25
7.4.3	View menu.....	7-26

8. ACCESSIBLE DEVICES AND RANGES	8-1 to 8-4
---	-------------------

8.1	Accessible Devices.....	8- 1
8.1.1	Host (personal computer (local station equivalent)).....	8- 1
8.1.2	Other station.....	8- 2
8.2	Accessible Range.....	8- 4

9. MELSEC DATA-LINK LIBRARY	9-1 to 9-8
------------------------------------	-------------------

9.1	Overview of the MELSEC Data-Link Library.....	9- 1
9.2	Function List.....	9- 2
9.3	Settings for Using Functions.....	9- 3
9.3.1	When using Visual Basic 5.0 and Visual Basic 6.0.....	9- 3
9.3.2	When using Visual C++ 5.0 and Visual C++ 6.0.....	9- 3
9.4	Procedure for Programming.....	9- 4
9.5	Channel.....	9- 5
9.6	Station Number Settings.....	9- 5
9.7	Device Types.....	9- 6

10. ERROR CODE	10-1 to 10-6
-----------------------	---------------------

11. TROUBLESHOOTING	11-1 to 11-18
----------------------------	----------------------

11.1 When Performing Troubleshooting	11- 1
11.2 Troubleshooting Table by the Type of Error Occurring	11- 2
11.3 Flowchart to Use when the Board or PC do not Operate	11- 3
11.3.1 Table of error event messages that may occur during driver startup.....	11- 5
11.4 Flowchart to Use when the Data Link could not be Completed	11- 7
11.4.1 Flowchart to use when RUN LED is unlit	11- 8
11.4.2 Flowchart to use when SD/RD LED does not turn on	11- 9
11.4.3 Flowchart to use when there is a communication error between the master station and I/F board.....	11-10
11.5 Flowchart to Use when an Error Occurs During Data Linking.....	11-12
11.5.1 Flowchart to use when unexpected value is input to specific link device.....	11-12
11.5.2 Flowchart to use when reading from and writing to the device cannot be done using the communication function	11-13
11.5.3 Flowchart to use when communication is disabled from time to time during user program execution	11-14
11.5.4 Flowchart to use when the system goes down or resets during the user program execution	11-15
11.6 Information Needed when Calling with Inquiry	11-17

APPENDIX	Appendix-1 to Appendix-3
-----------------	---------------------------------

Appendix 1 External Dimensions	Appendix- 1
Appendix 2 Measures Regarding Year 2000 Problem	Appendix- 2

About This Manual

The following are manuals related to this product.

Request for the manuals as needed according to the chart below.

Related Manuals

Manual Name	Manual No. (Type code)
CC-Link System Master/ Local type AJ61BT11/A1SJ61BT11 User's Manual This manual explains the system configuration, performance specifications, functions, handling, wiring and troubleshooting for the AJ61BT11 and A1SJ61BT11. (Sold separately)	IB-66721 (13J872)
CC-Link System Master/Local Module type AJ61QBT11/A1SJ61QBT11 User's Manual This manual explains the system configuration, performance specifications, functions, handling, wiring and troubleshooting for the AJ61QBT11 and A1SJ61QBT11. (Sold separately)	IB-66722 (13J873)
CC-Link System Master/Local Module type QJ61BT11 User's Manual This manual explains the system configuration, performance specifications, functions, handling, wiring and troubleshooting for the QJ61BT11. (Sold separately)	—————

How to Read the Manual

"How to Read the Manual" is listed according to the objective when using the I/F board. Refer to the following when using this manual.

(1) To learn about the features of the I/F board (Section 1.1)

The features are described in Section 1.1.

(2) To learn about compatibility with existing software (Section 1.2)

Compatibility with existing software is described in Section 1.2.

(3) To learn about the correspondence to the EMC command (Chapter 2)

Correspondence to the EMC command is described in Chapter 2.

(4) To learn about the system configuration (Section 3.1 to Section 3.2)

Configuration of a system using the I/F board is described.

(5) To learn about the operating environment for the I/F board (Section 3.3)

The operating environment for the I/F board is described in Section 3.3.

(6) To learn about specifications and functions for the I/F board (Chapter 4)

The specifications and functions for the I/F board are described in Chapter 4.

(7) To learn about I/F board settings (Chapter 5)

I/F board settings are described in Chapter 5.

(8) When installing or uninstalling a software package (Chapter 6)

How to install and uninstall a software packaged is described in Chapter 6.

(9) To learn about utilities operating procedure (Chapter 7)

The operating procedure for utilities is described in Chapter 7.

(10) To learn about devices that can be accessed and range of access (Chapter 8)

Device specifications and contents stored in the system-area information are described in Chapter 8.

(11) To learn about how to use functions (Chapter 9)

How to use functions is described in Chapter 9.

(12) To learn about error contents (Chapter 10)

The contents of errors is described in Chapter 10.

(13) To learn about the actions to take when the system does not run (Chapter 11)

How to troubleshoot is described in Chapter 11.

Abbreviations and General Terms Used in This Manual

Unless specifically noted, this manual uses the abbreviations and general terms listed below to explain the A80BDE-J61BT13 model CC-Link interface boards.

Abbreviation/general term		Description of the abbreviation/general term
I/F board		Abbreviation for the A80BDE-J61BT13 model CC-Link interface board.
CC-Link		Abbreviation for the Control & Communication Link system.
Windows NT 4.0		Abbreviation for Microsoft Windows NT Workstation 4.0 (English version).
Windows 95		Abbreviation for Microsoft Windows 95 (English version).
Windows 98		Abbreviation for Microsoft Windows 98 (English version).
Windows		General term for Microsoft Windows 95 (English version), Windows 98 (English version) and Windows NT Workstation 4.0 (English version).
IBM PC/AT compatible PC		An IBM PC/AT compatible PC.
AnNCPU		General term for A0J2HCPU, A1SCPU, A1SCPU-S1, A1SCPUC24-R2, A1SHCPU, A1SJCPU, A1SJCPU-S3, A1SJHCPU, A1SJHCPU-S8, A1NCPU, A2CCPU, A2CCPUC24, A2CCPUC24-PRF, A2CJCPU, A2NCPU, A2NCPU-S1, A2SCPU, A2SCPU-S1, A2SHCPU, A2SHCPU-S1 and A1FXCPU.
AnACPU		General term for A2ACPU, A2ACPU-S1, A2ACPUP21/R21, A2ACPUP21/R21-S1, A3ACPUP21/R21, A3NCPU and A3ACPU.
AnUCPU		General term for A2UCPU, A2UCPU-S1, A2ASCPU-S1, A2ASCPU-S30, A2USHCPU-S1, A3UCPU and A4UCPU.
QnACPU		General term for Q2ACPU, Q2ACPU-S1, Q2ASCPU, Q2ASCPU-S1, Q2ASHCPU, Q2ASHCPU-S1, Q3ACPU, Q4ACPU and Q4ARCPU.
ACPU		General term for AnNCPU, AnACPU and AnUCPU.
QCPU	A mode	General term for Q02CPU-A, Q02HCPU-A and Q06HCPU-A.
	Q mode	General term for Q02CPU, Q02HCPU, Q06HCPU, Q12HCPU and Q25HCPU.
Master station		The station controlling the remote station, local station and intelligent device station.
Local station		A station that has a CPU and can communicate with the master station and local station.
Remote I/O station		A remote station that can only handle bit information. (AJ65BTB□-□□, AJ65BTC□-□□)
Remote station		General term for the remote I/O station and remote device station.
Intelligent device station		A slave station such as the AJ65BT-R2 in the CC-Link system that can perform transient transmission.
Master and local modules		General term for the AJ61QBT11, A1SJ61QBT11, AJ61BT11, A1SJ61BT11 and QJ61BT11.
Master module		General term when the AJ61QBT11, A1SJ61QBT11, AJ61BT11, A1SJ61BT11 and QJ61BT11 are used as master stations.
Remote module		General term for AJ65BTB □-□□, AJ65BTC □-□□, AJ65BT-64AD, AJ65BT-64DAV, AJ65BT-64DAI, A852GOT, etc.
Intelligent module		A module such as the AJ65BT-R2 that can perform transient transmission.
Cyclic transmission		Function that periodically updates the contents of the remote I/O and remote register.
Transient transmission		Function that communicates data to the specified station when there is an access request from the PLC CPU.
SB		Link special relay
SW		Link special register
RX		Remote input
RY		Remote output
RWw		Remote register (write area)
RWr		Remote register (read area)

Microsoft Windows, Microsoft Windows NT, Microsoft Visual Basic, Microsoft Visual C++ and MS-DOS are registered trademarks of Microsoft Corporation in the United States.

Other company names or product names found in the text are trademarks or registered trademarks of each company.

Product Structure

The product structure for the I/F board is given in the table below.

Product name	Quantity
A80BDE-J61BT13 model CC-Link interface board	1
SW3DNF-CCLINK model CC-Link software package	1 (Floppy disks; set of 5)
Type A80BDE-J61BT13 CC-Link interface board user's manual (this manual)	1
Software use agreement	1
User entry card	1

Note

The terminal resistor is packaged with the CC-Link system master and local modules.

1. OVERVIEW

This manual explains the specifications for, and how to handle and monitor the A80BDE-J61BT13 model CC-Link interface board that is included in the CC-Link system, and loaded as an optional board in the PCI* bus of an IBM PC/AT compatible PC.

The A80BDE-J61BT13 is applicable to the following CC-Link system.

- Applicable to the CC-Link system local station(s).

* : PCI is the abbreviation for Peripheral Component Interconnect.

1.1 Features

The I/F board has the features described below.

(1) An IBM PC/AT compatible PC can be built into the CC-Link system.

The I/F board can be installed in an IBM PC/AT compatible PC and that PC can be used as a local station.

(2) Using a PCI bus eliminates troublesome switch settings.

Simply installing the board in the PCI bus automatically executes initial setting.

(3) Displays test and monitor information related to the CC-Link.

Operation becomes easy since the CC-Link system testing and monitoring statuses can be displayed in the IBM PC/AT compatible PC.

(4) Various functions are available to accommodate user programming.

By using various functions that are compatible with Visual C++ and Visual Basic, user applications to perform remote control for the PLC CPU as well as reading from and writing to devices can easily be created.

(5) Drivers for various operating systems are available.

A variety of drivers are provided to make it easier to construct a system that is compatible with the user's environment.

Compatible operating systems :

- Windows 95 (English version)
- Windows 98 (English version)
- Windows NT Workstation 4.0 (English version)

1.2 Compatibility with Existing Software

Compatibility with existing software is indicated in the table below.

	SW3DNF-CCLINK	Remark
SW0DNF-CCLINK	x	Earlier software package
SW1DNF-CCLINK	x	
SW2DNF-CCLINK	x	
SW0IVDWT-MNET10P	x	
SW1IVDWT-MNET10P	○	
SW2DNF-MNET10	○	
SW1D5F-CSKP-E	x	
SW2D5F-CSKP-E	○	
SW3DNF-MNET10	○	—
SW3D5F-CSKP-E	○	

○ : Simultaneous operation possible x : Simultaneous operation not possible

Point
(1) User program EXE files generated using the MDFUNC32.LIB of the earlier software package must be relinked using the MDFUNC32.LIB contained in the new driver software package.
(2) When connecting to the QCPU (Q mode), be sure to use an I/F board whose ROM version is "W" or later. The system will not operate correctly if an I/F board of "V" or older ROM version is used.

2. EMC COMMAND

2.1 Requirements for EMC Command Compliance

EMC commands, which are among the European command sets, are now enforced.

The EMC commands regulate "emission (electromagnetic interference)," which requires that a device not emit strong electromagnetic waves externally, and "immunity (electromagnetic sensitivity)," which requires that a device have the ability to resist external electromagnetic waves.

The precautionary items when configuring a machine device using an I/F board to conform to EMC commands are described in sections 2.1.1 through 2.1.4.

Although we tried very hard to document these materials according to the requirements for regulation and the standards we have researched, the compatibility to the above commands of the entire device created according to the contents of this material, is not guaranteed. The methods to enable a device to conform to the commands and the compatibility must be determined by the manufacturer who produces the machine device.

2.1.1 EMC commands

The standards relating to EMC commands are listed in the table below:

With all test items, the standard has been tested with each device installed in an IBM PC/AT compatible PC bearing a CE certification logo.

Specification	Test item	Test description	Standard values
EN50081-2 : 1995	EN55011 Radiated noise	Measure the electric wave released by the product.	30 M-230 MHz QP : 50 dB μ V/m (3 m measurement) *1 230 M-1000 MHz QP : 57 dB μ V/m (3 m measurement)
	EN55011 Conduction noise	Measure the noise released by the product to the power line.	150 k-500 kHz QP: 79 dB, Mean: 66 dB *1 500 k-30 MHz QP: 73 dB, Mean: 60 dB
prEN50052-2 : 1991	IEC801-2 Static electricity immunity	Immunity test by applying static electricity to the unit enclosure.	4 kV contact discharge 8 kV air discharge
	IEC801-3 Radiated electromagnetic field	Immunity test by radiating an electric field to the product.	10 V/m, 27 - 500 MHz
	IEC801-4 First transient burst noise	Immunity test by applying burst noise to the power line and signal line.	2 kV
EN50082-2 : 1995	EN61000-4-2 Static electricity immunity	Immunity test by applying static electricity to the unit enclosure.	4 kV contact discharge 8 kV air discharge
	EN61000-4-4 First transient burst noise	Immunity test by applying burst noise to the power line and signal line.	2 kV
	ENV50140 Radiated electromagnetic field AM modulation	Immunity test by radiating an electric field to the product.	10 V/m, 80-1000 MHz, 80 % AM modulation@1 kHz
	ENV50204 Radiated electromagnetic field Pulse modulation	Immunity test by radiating an electric field to the product.	10 V/m, 900 MHz, 200 Hz pulse modulation, 50 % duty
	ENV50141 Conduction noise	Immunity test by inducting electromagnetic field to the power line and signal line.	10 Vrms, 0.15-80 MHz, 80 % AM modulation@1 kHz

*1 QP (Quasi-Peak) : Quasi-peak value, Mean: Average value

2.1.2 Installation on the control panel

Installing devices on the control panel has a considerable effect not only in securing safety but also in shutting down the noise generated from the PC by the control panel.

(1) Control panel

- (a) Use an electrically conductive control panel.
- (b) When fastening/tightening the control panel's top or bottom panel with bolts, mask the coating so that surface contact is feasible.
- (c) To ensure the electrical contact between the inside panel of the control panel and the main control panel, mask any coating around the installation bolts connecting to the main unit to secure conductivity in the largest surface area possible.
- (d) Ground the control panel main unit using a thick ground cable so that a low impedance can be secured even with a high frequency.
- (e) Make the holes on the control panel less than 10 cm (3.94 in.) in diameter. A hole larger than 10 cm (3.94 in.) may leak electric waves.

(2) Layout of power supply cable and ground cable

The layout of power supply cable and ground cable for a PC should be set as described below.

- (a) Specify a grounding point that enables grounding of the control panel close to the power supply to the PC and ground the FG (frame ground) terminal of the PC or the SLD (shield) terminal of the I/F board using the thickest, shortest cable possible (about 30 cm (11.81 in.) or less in length). Since the FG and SLD terminals play a role in grounding the noise generated in the PC, it is necessary to ensure the lowest possible impedance. Because the power line is used to allow the noise to escape, it actually contains a great deal of noise. Therefore, shortening the wire length prevents the power line from becoming an antenna.

Note : A long conductive material can become an antenna that emits noise more efficiently.

- (b) Twist the ground cable leading to the ground point with the power supply cable. By twisting them with the ground cable, the noise leaking out of the power supply cable may be grounded at a higher rate. However, when a noise filter is installed to the power supply cable, twisting with the ground cable may not be necessary.

2.1.3 Cable

Because the cable that runs from the control panel contains high frequency noise, outside the control panel it acts as an antenna and radiates noise. Always use shielded cable for cable that runs outside the control panel.

Except for certain models, using the ferrite core is not mandatory. However, the noise radiated via cable can be suppressed more effectively by mounting a ferrite core.

Using a shielded cable is also effective in raising noise resistance. The signal lines used for PLC input/output and special units are designed to ensure a noise resistance level of 2 kV (IEC801-4/EN61000-4-4) if a shielded cable is used. If a shielded cable is not used, or when a shielded cable is not grounded properly, the noise resistance will drop below 2 kV.

Note : With the EN50082-2, the noise resistance of each signal line is specified based on the application of the signal.

- Signals related to control (process control) : 2 kV
- Signals not related to control (process control) : 1 kV

In the EN50082-2, the meaning of “(signals) related to control” is not defined. However, considering the original intent of the EMC command, the signal line that poses possible danger to person or equipment when the panel is incorrectly operated shall be defined as the “signal related to control,” and high noise resistance is considered mandatory.

(1) Grounding treatment for shields

- (a) Perform shielding processing at a position near the exit of the control panel. If the grounding point is far from the exit position, the cable portion after the grounding point will cause electromagnetic induction and generates high-frequency noise.
- (b) Use a grounding method that allows the shield a surface grounding in a large area against the control panel. A clamping fixture as shown below may alternatively be used. When such a fixture is used, mask the coating in the area inside the control panel where the fixture contacts.

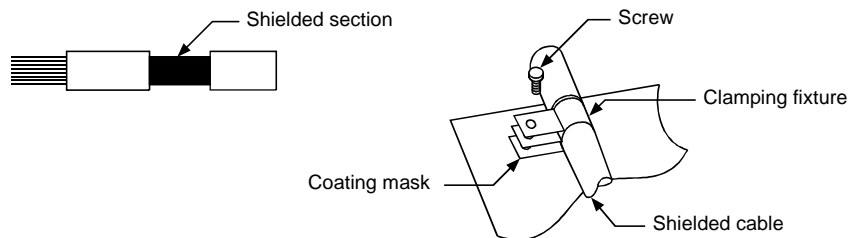

Note : The method shown below in which a PVC electric wire is soldered to the shield of the shielded cable and that end is grounded, increases the high frequency impedance and the effectiveness of the shield is lost.

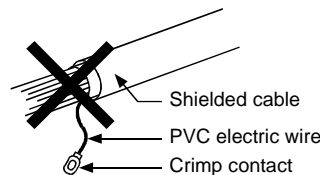

(2) Grounding treatment for the CC-Link cable

- (a) Always ground the twisted cable connected to the CC-Link master station, local station and remote station.

Since the twisted cable is a shielded cable, remove part of the outer sheath. Then ground the exposed part of the shield indicated in the figure below as wide a surface area as possible.

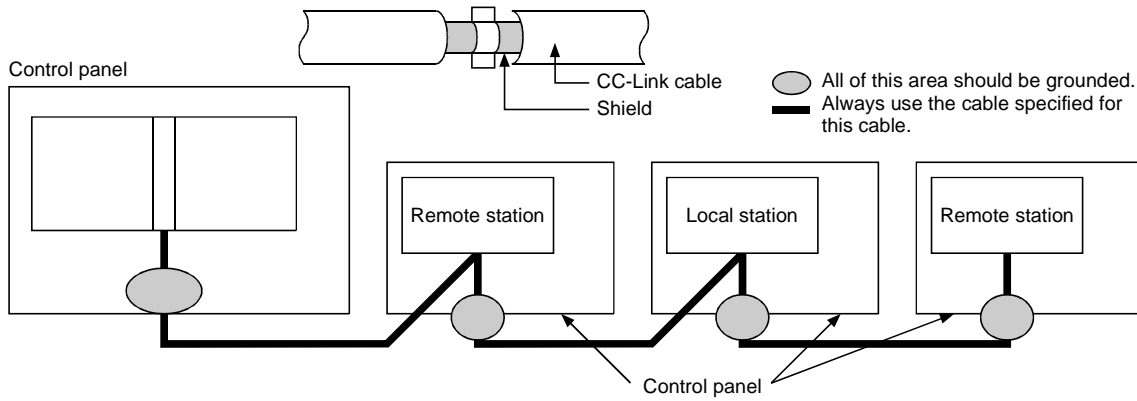

Also, ground within 30 cm (11.81.in.) from the board terminal area in addition to grounding at the position closest to the exit of the control panel.

- (b) Always use the specified cable for the CC-Link cable.
- (c) For each module, do not use a ferrite core for the CC-Link cable from the board.
- (d) For each module, ground both the FG terminal and SLD terminal of the board.

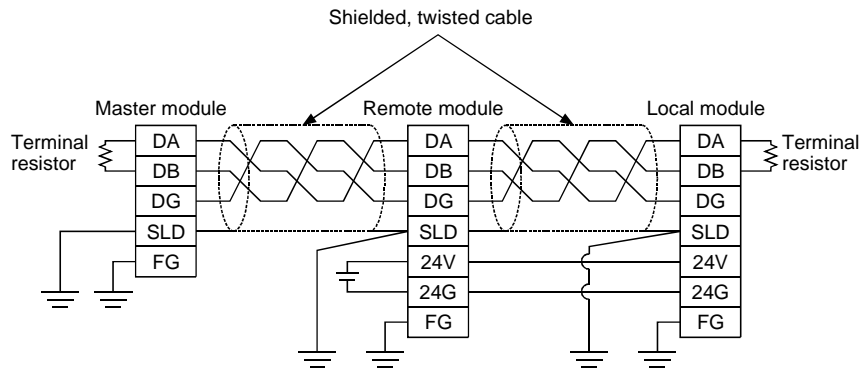

2.1.4 Noise filter (power supply line filter)

A noise filter is a part that has a considerable effect in preventing conductive noise. Except for a few models, installation of a noise filter to the power supply line is not mandatory. However, the installation of a noise filter can suppress noise at a higher rate (a noise filter is effective for reducing noise emitted in the range below 10MHz). Use a noise filter equivalent to the models shown below.

Model	FN343-3/01	FN660-6/06	ZHC2203-11
Manufacturer	SCHAFFNER	SCHAFFNER	TDK
Rated current	3 A	6 A	3 A
Rated voltage	250 V		

Precautions when installing a noise filter are noted below.

- (1) Do not bundle the wiring on the input and output side of the noise filter. If they are bundled, noise on the output side will be inducted to the wiring on the input side where the noise has been removed by a filter.

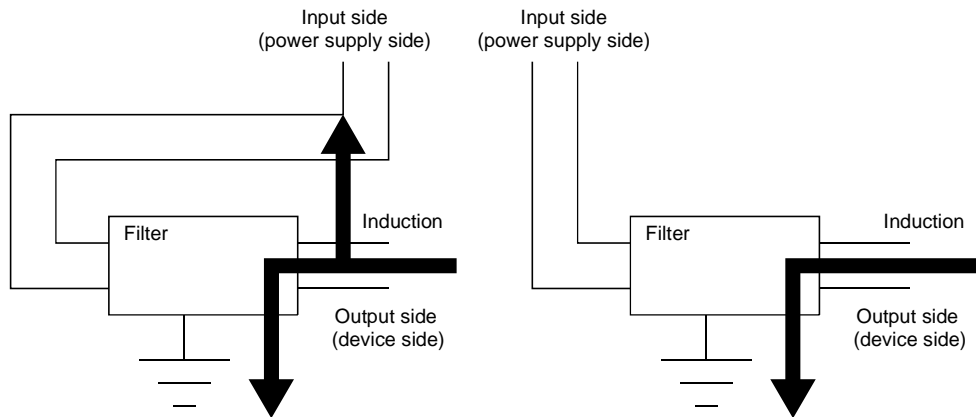

- (2) Ground the ground terminal for the noise filter to the control panel using as short wiring as possible (about 10 cm (3.94 in.)).

3. SYSTEM CONFIGURATION

The configuration for a system using the I/F board is explained below.

3.1 System Configuration for A80BDE-J61BT13

The following indicates the system configuration when an I/F board is used.

The I/F board can be connected to a maximum of up to 26 modules per 1 master station.

However, the following conditions must be fulfilled.

(1) $\{(1 \times a) + (2 \times b) + (3 \times c) + (4 \times d)\} \leq 64$

a : Number of modules occupied by 1 station

b : Number of modules occupied by 2 stations

c : Number of modules occupied by 3 stations

d : Number of modules occupied by 4 stations

(2) $\{(16 \times A) + (54 \times B) + (88 \times C)\} \leq 2304$

A : Number of remote I/O stations ≤ 64

B : Number of remote device stations ≤ 42

C : The number of local stations, standby master stations and intelligent device stations ≤ 26

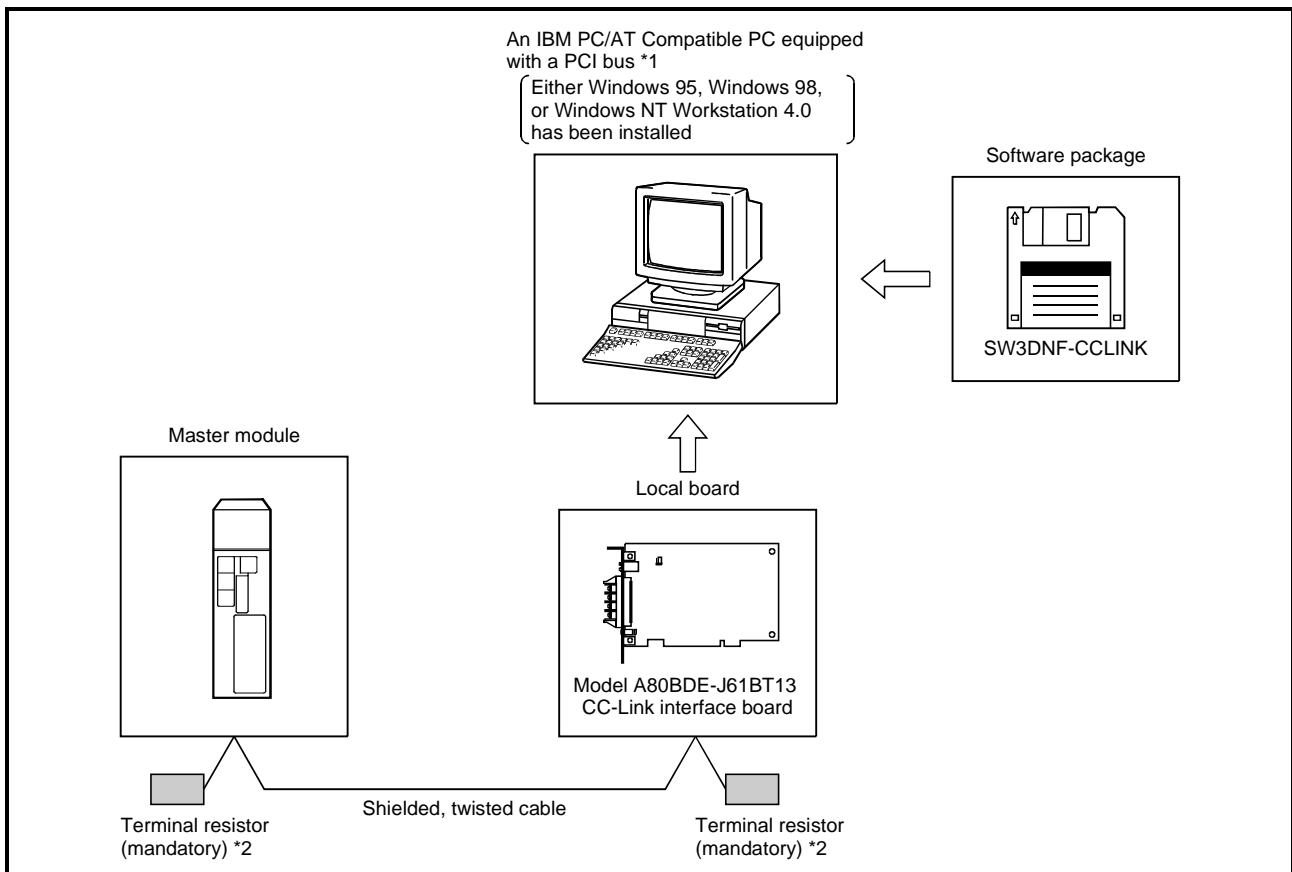

*1 : A multiprocessor PC cannot be used, since the drivers are not compatible.

*2 : The terminal resistor comes with the master module.

3.2 Applicable System

The CC-Link system master module which can use an I/F board is explained below.

The master module that can use an I/F board is the product with function version B or later and software version N or later.

The product with earlier versions than those listed above cannot use an I/F board.

The function version is recorded in the DATE column of the rated plate.

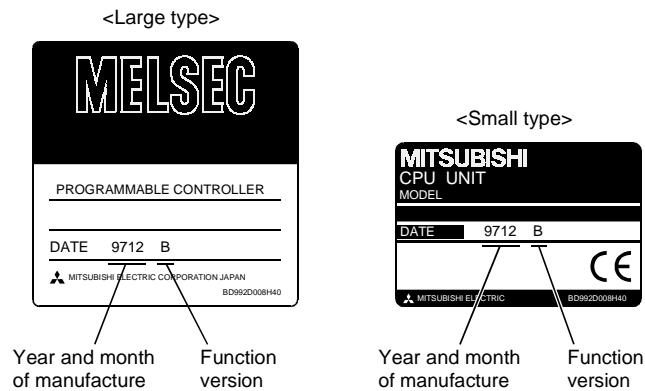

*The function version is noted only on products with version B or later.

The software version is indicated on the module version tag located on the front of the module.

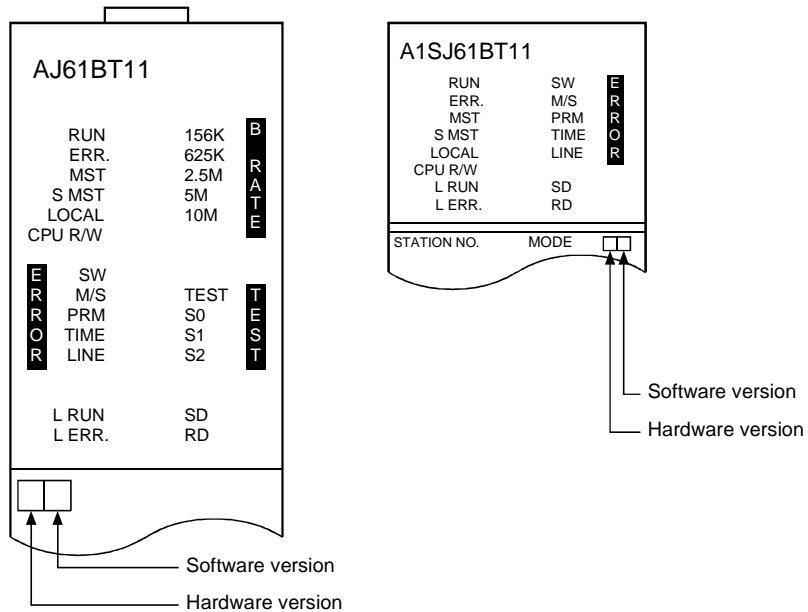

3.3 Operating Environment

The operating environment for the I/F board is shown below.

Item	Description
PC unit	PC with a Pentium 133 MHz or higher, one or more PCI bus slots, and running Windows 95, Windows 98, or Windows NT Workstation 4.0
PCI bus specification	5 V DC, 32 bit bus Basic clock: 33 MHz
Operating system	Either of Windows 95 (English version), Windows 98 (English version), or Windows NT Workstation 4.0 (English version)
Programming language	Visual Basic Ver5.0 (English version), Visual Basic Ver6.0 (English Version), Visual C++ Ver5.0 (English version), Visual C++ Ver6.0 (English Version)
Required memory size	32 MB or more
Hard disk space	15 MB or more
Disk drive (required when installing the driver)	3.5 inch (1.44 MB) floppy disk drive

Note

A multiprocessor PC cannot be used, since the drivers are not compatible.

4. SPECIFICATION

The performance specifications and functions of the I/F board are explained below.

4.1 General Specification

(1) The following table indicates general specifications of the I/F board.

Item	Specification					
Usage ambient temperature	0 to 55 °C					
Storage ambient temperature	-20 to 75 °C					
Usage ambient humidity	10 to 90 %RH, no condensation					
Storage ambient humidity	10 to 90 %RH, no condensation					
Vibration durability	Conforming to JIS B 3501, IEC 61131-2		Frequency	Acceleration	Amplitude	Sweep count
		When there is intermittent vibration	10 to 57 Hz	—	0.075 mm (0.0030 inch)	10 times in each direction X, Y, Z (80 minutes)
			57 to 150 Hz	9.8 m/s ²	—	
		When there is continuous vibration	10 to 57 Hz	—	0.035 mm (0.0013 inch)	
57 to 150 Hz	4.9 m/s ²		—			
Shock durability	Conforming to JIS B 3501, IEC61131-2 (147 m/s ² , 3 times each in 3 directions)					
Usage environment	No corrosive gas					
Usage height	Less than 2000 m (less than 6562 ft.)					
Installation area	Within the control board					
Over-voltage category *1	Less than II					
Pollution level *2	Less than 2					

*1 Indicates the location where the device is connected from the public cable network to the device structure wiring area.

Category II applies to the devices to which the power is supplied from a fixed equipment. Surge withstand voltage for devices with up to 300 V of rated voltage is 2500 V.

*2 This is an index which indicates the degree of conductive object generation in the environment

Pollution level 2 is when only non-conductive pollution occurs.

A temporary conductivity caused by condensation must be expected occasionally.

(2) General specifications of the I/F board after it has been installed conform to the IBM PC/AT compatible PC unit.

4.2 Performance Specifications

The following table indicates the performance specifications for the I/F board.

Item	Specification
Transmission speed	156 kbps, 625kbps, 2.5 Mbps, 5 Mbps or 10 Mbps can be selected
Maximum transmission distance	Differs depending on the transmission speed. (See Section 4.3)
Number of occupied stations	1 or 4 station(s) (switches depending on the setting)
Maximum number of link points per 1 system	Remote I/O (RX, RY) : 2048 Remote registers (RWw) : 256 (master station to local station) Remote registers (RWr) : 256 (local station to master station)
Number of link points per 1 station	Remote I/O (RX, RY) : 30 Remote registers (RWw) : 4 (master station to local station) Remote registers (RWr) : 4 (local station to master station)
Communication method	Polling method
Synchronous method	Frame synchronous method
Encoding method	NRZI method
Transmission path	Bus (RS485)
Transmission format	Conforms to HDLC
Error control system	CRC($X^{16}+X^{12}+X^5+1$)
Cable	Shielded, twisted cable (Section 4.4 Recommended cable)
RAS functions	<ul style="list-style-type: none"> • Automatic return function • Slave station separation function • Error detection using the link special relay and register • Data link status verification • OFF-line test (hardware test, line test) • Abnormal temperature detection • Watchdog timer error (WDT) detection
Number of boards that can be loaded	Maximum of 4
Loading slot	IBM PC/AT compatible PC PCI bus slot
Number of slots occupied	1 slot
Internal voltage consumption (5 V DC)	0.4 A
Weight	0.16 kg (0.35 lb)

4.3 Total Extension Distance and Between-Station Distance in the CC-Link System

The following indicates the total extension distance and between-station distance in the CC-Link system.

- 1) Regardless of the transmission speed setting, the length of the cable must be "2 m (6.56 ft.) or more" between master stations, local stations, as well as intelligent device stations and each of their previous and next stations, respectively.
- 2) When the transmission speed is 5 Mbps or 10 Mbps, it is necessary to note that the maximum transmission distance varies depending on the length of the cable between the remote I/O station and remote device station.

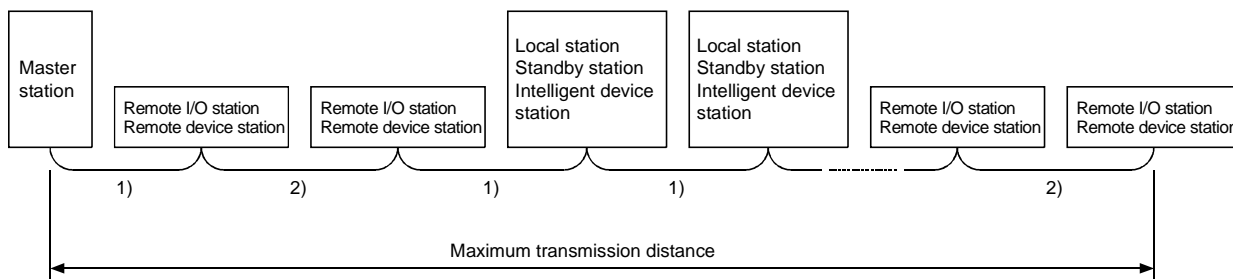

(1) When a CC-Link dedicated cable is used (terminal register 110 Ω is used)

Transmission speed	1)	2)	Maximum transmission distance
156 kbps	2 m (6.56 ft) or more	30 cm (11.81 in.) or more	1200 m (3937.2 ft)
625 kbps		30 cm (11.81 in.) or more	600 m (1968.6 ft)
2.5 Mbps		30 cm (11.81 in.) or more	200 m (656.2 ft)
5 Mbps		60 cm (23.62 in.) or more	150 m (492.15 ft)
		30 to 59 cm (11.81 to 23.23 in.)	110 m (360.91 ft)
10 Mbps		1 m (3.28 ft) or more	100 m (328.1 ft)
		60 to 99 cm (23.23 to 38.98 in.)	80 m (262.48 ft)
		30 to 59 cm (11.81 to 23.23 in.)	50 m (164.05 ft)

(2) When a CC-Link dedicated high-quality cable is used (terminal register 130 Ω is used)

Transmission speed	1)	2)	Maximum transmission distance
156 kbps	2 m (6.56 ft) or more	30 cm (11.81 in.) or more	1200 m (3937.2 ft)
625 kbps		30 cm (11.81 in.) or more	600 m (1968.6 ft)
2.5 Mbps		30 cm (11.81 in.) or more	200 m (656.2 ft)
5 Mbps		60 cm (23.62 in.) or more	150 m (492.15 ft)
		30 to 59 cm (11.81 to 23.23 in.)	110 m (360.91 ft)
10 Mbps		1 m (3.28 ft) or more	80 m (262.48 ft)
		70 to 99 cm (27.6 to 39 in.)	50 m (164.05 ft)

4.4 Twisted Cable Specifications

The following table indicates the specifications for the twisted cable that can be used with the CC-Link and the recommended cable.

The performance of the CC-Link cannot be guaranteed when cable other than the one recommended below is used.

Item	Specification
Model	FANC-SB 0.5 mm ² × 3
Cable type	Shielded, twisted cable
Conductor sectional area	0.5 mm ²
Conductor resistance (20 °C)	37.8 Ω/km or less
Insulation resistance	10,000 Ω-km or more
Dielectric withstand voltage	500 V DC 1 minute
Electrostatic capacity (1 kHz)	60 nF/km or less
Characteristic impedance (1 MHz)	100 ±15 Ω
Cross-section	
Overall dimensions	7 mm (0.28 in.)
Approximate weight	65 kg/km

4.5 List of Functions

The following table lists the I/F board functions.

Name	Contents
Data communication function	(1) Communication for remote input (RX), remote output (RY), remote register (RWw, RWr) via the CC-Link is possible using the cyclic transmission function. <ul style="list-style-type: none"> Number of link points per station <ul style="list-style-type: none"> Remote I/O (RX, RY) : 30 Remote register (RWw) : 4 Remote register (RWr) : 4 (2) Communication with the master station and intelligent device station is possible using the transient transmission function.
Test function	Tests can be performed and the hardware checked using the test mode setting.
RAS functions	Automatic return function, slave station separation function, verification of data link status, off-line test
Self-diagnostic function	<ul style="list-style-type: none"> An error message is displayed according to the error code. Contents of the fault detected are stored in the special relay or special register.

5. PROCEDURE AND SETTINGS UP TO THE POINT OF OPERATION

This section explains the operating procedure up to the point the I/F board is operated, as well as the names and setting for each part of the I/F board, wiring method and hardware testing.

5.1 Procedure Up to the Point of Operation

An outline of the procedure up to the point of I/F board operation is explained below.

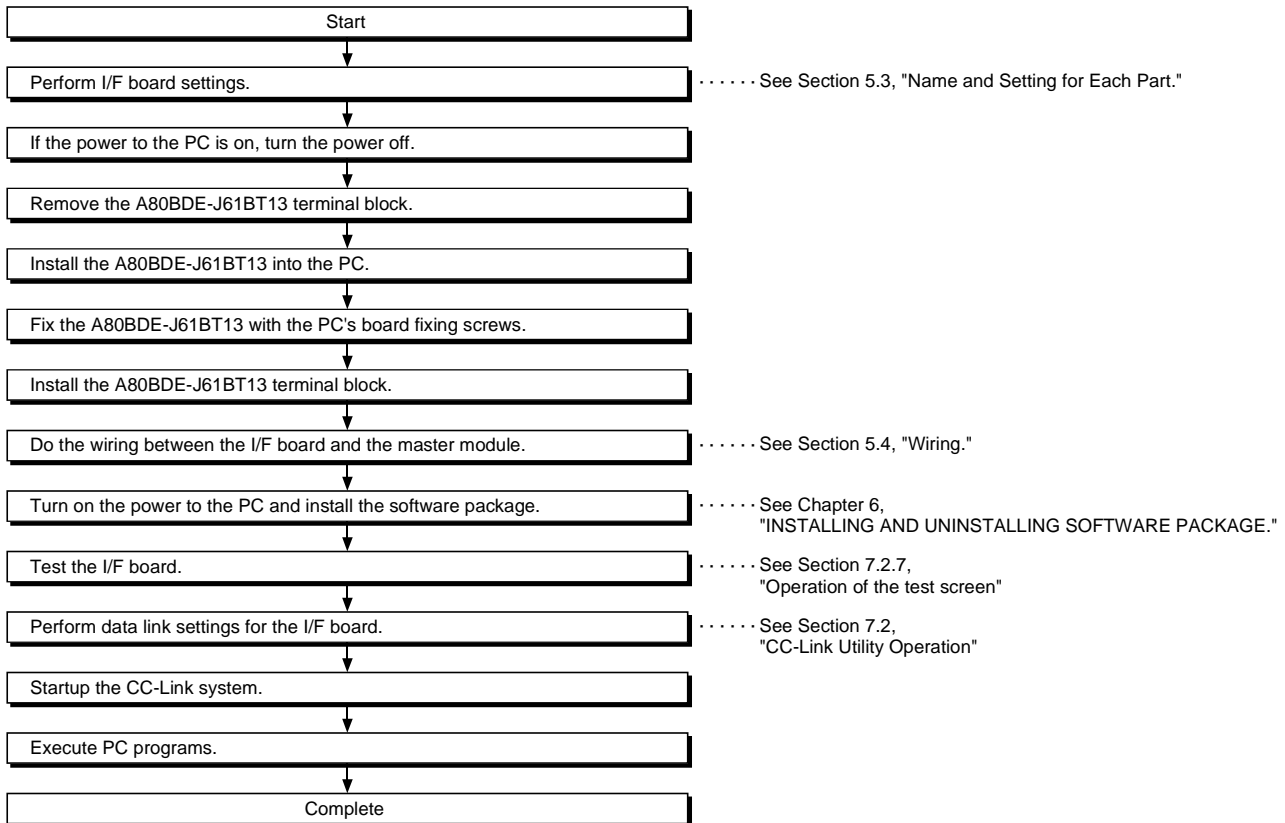

Note

Setting on the master module side is mandatory in order to run the CC-Link system. Perform the settings for the master module side as required.

See the user manual for the master module regarding the master module settings.

5.2 Installation

This section gives precautions when handling the I/F board and explains the installation environment.

5.2.1 Precautions when handling

The followings are precautions to be noted when handling the I/F board.



DANGER

- Do not touch the terminal or the connector while the power is turned on. Doing so may result in electric shock or cause malfunctioning.



CAUTION

- Fasten the I/F board securely using the installation screws and tighten the installation screws securely within the specified torque range. If the screws are loose, this may cause malfunctioning. If the screws are tightened too much, this could cause damage to the screws or module, leading to malfunctioning.
- Do not directly touch the conductive section of the I/F board. Doing so could result in malfunctioning or breakdown of the I/F board.
- Tighten the terminal screws within the specified torque range. If the terminal screws are loose, this may lead to a short or malfunctioning. If the terminal screws are tightened too much, this could cause damage to the screws or I/F board, leading to a short or malfunctioning.
- Handle the I/F board in a location where there is no static electricity. Static electricity could result in failure or malfunctioning.
- Take care that foreign objects such as chips or wiring debris do not get into the PC. This could result in fire, breakdowns or malfunctioning.
- Do not dismantle or rebuild the I/F board. This will result in failure, malfunctioning, injury or fire.
- Always turn off all external power before installing or removing the I/F board. If power is not turned off at all phases, there is a risk of electric shock or damage to the product.
- When discarding the product, handle it as an industrial waste.
- Do not drop the I/F board or subject it to strong impact. This will result in failure or malfunctioning of the board.

- (1) The tightening torque for the I/F board terminal screws and fixing screws should fall within the range indicated in the table below.

Screw locations	Tightening torque range
Terminal block terminal screws (M3.5 screw)	59 to 88 N·cm
Terminal block installation screws (M3.5 screw)	59 to 88 N·cm

- (2) See the manual attached to the PC unit for the tightening torque of I/F board installing screws.

5.2.2 Installation environment

See the instruction manual accompanying the PC unit regarding installation of the PC unit in which the I/F board is mounted.



CAUTION

- Always ground the PC unit using grounding type D (Class 3 grounding). Otherwise, there is the risk of malfunctioning.
If there is an error in operation even when the PC unit is grounded, ground the FG terminal of the PC unit as well as the SLD terminal of the I/F board.

5.2.3 How to remove the terminal block

The I/F board uses a two-piece terminal block, so that the I/F board can be replaced without disconnecting the signal line to the terminal block.

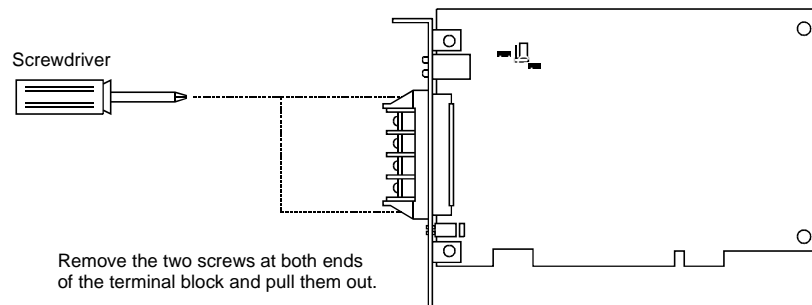

The illustration below shows how to remove the block.

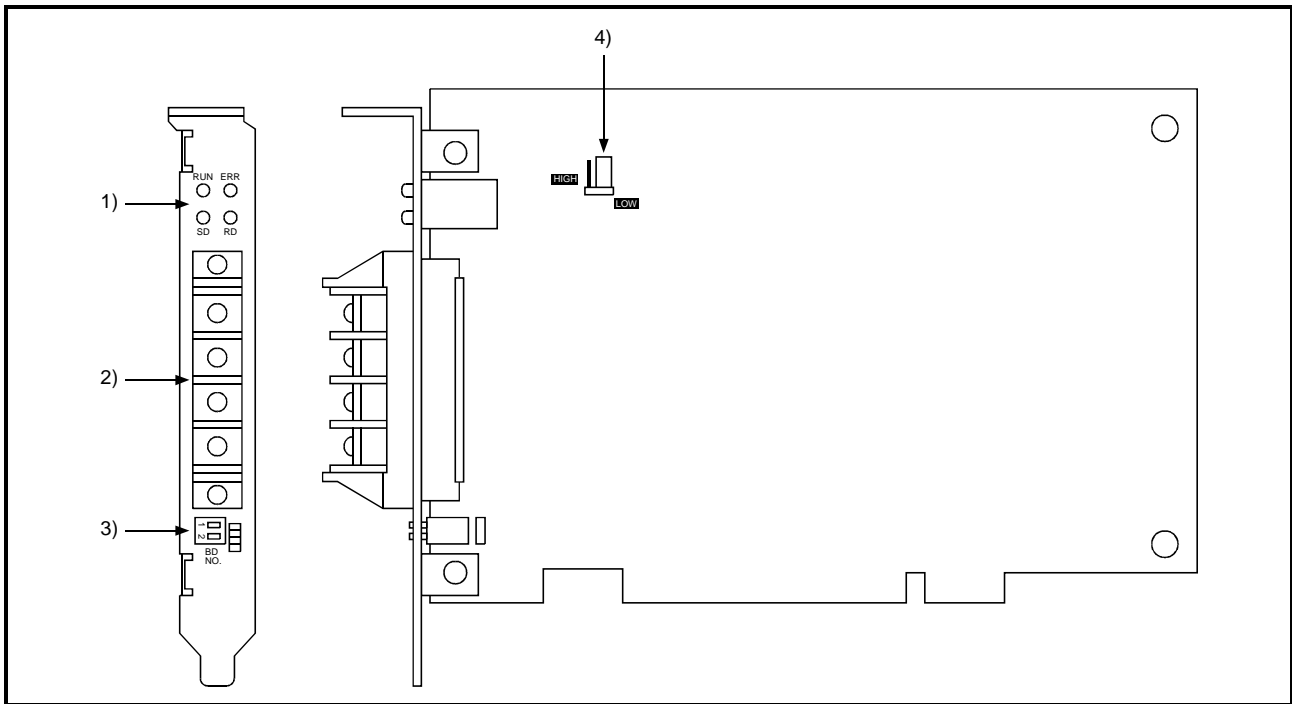

5.3 Name and Setting for Each Part

This section explains the name and settings for each part of the I/F board.

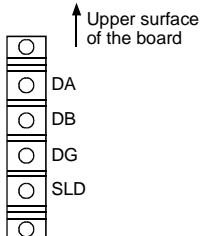

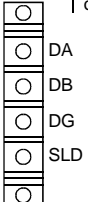
Number	Name	Contents			
		LED nomenclature	Contents	ON	OFF
1)	Operation display LED RUN ERR  SD RD 	RUN	Lights when the I/F board is running properly and turns off when a WDT error occurs	I/F board is normal	<ul style="list-style-type: none"> WDT error PC power is OFF
		ERR.	Lights when there is an error in the network communication status	Data link communication error	Data link communication normal
		SD	Flashes when the data link is transmitting data	Flashes while the data link is transmitting	
		RD	Flashes when the data link is receiving data	Flashes while the data link is receiving data	
2)	Terminal block for the data link  ↑ Upper surface of the board	Connect a twisted cable to perform the data link. (2-piece terminal block)			

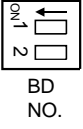
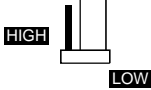
Number	Name	Contents				
3)	Channel number setting switch  BD NO.	Sets the channel number for the I/F board.				
		Board number	Channel number	Switch		Notes
				1	2	
		0	81	OFF	OFF	Default setting
		1	82	ON	OFF	
		2	83	OFF	ON	
		3	84	ON	ON	
		Set the board number, so that there is no duplication when two or more I/F boards are installed.				
4)	Switch setting pin for abnormal temperature detection 	Sets the temperature at which to be detected when there is an abnormal temperature.				
		Setting	Contents		Notes	
		HIGH	Set the detect temperature at 55 °C.			
		LOW	Set the detect temperature at 45 °C.		Default setting	

5.4 Wiring

5.4.1 Precautions when handling the twisted cable

There is the risk of damage to the twisted cable if it is handled in an extreme fashion. Therefore, do not handle the cable in the following manner.

- (1) Crushing the cable.
- (2) Twisting the cable with extreme force.
- (3) Pulling the cable with extreme force. (greater than the allowable tension)
- (4) Stepping on the cable.
- (5) Placing objects on top of the cable.
- (6) Damaging the cable cover.

5.4.2 How to wire to each module

The following indicates how to wire the twisted cable for the master module, remote module and I/F board.

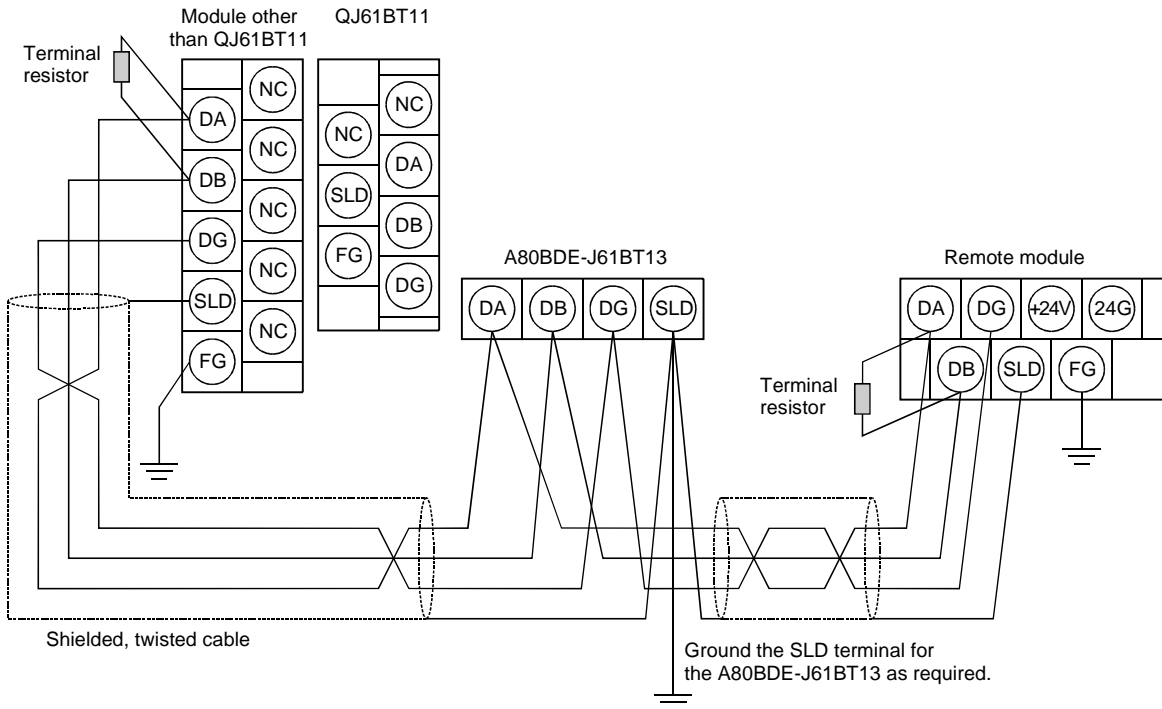

[Simplified diagram]

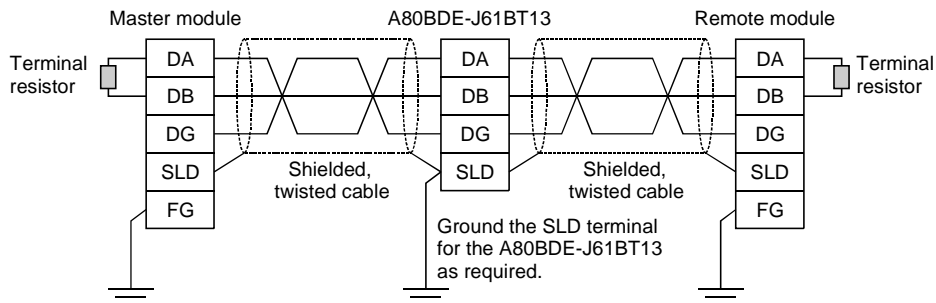

CAUTION

- Always ground the PC unit using grounding type D (Class 3 grounding). Otherwise, there is the risk of malfunctioning. If there is an error in operation even when the PC unit is grounded, ground the FG terminal of the PC unit as well as the SLD terminal of the I/F board.

- Point**
- (1) There is a difference in layout between the terminal block for QJ61BT11 and that of other than QJ61BT11.
 - (2) Always connect the "terminal resistor" that comes with the master module to the modules at both ends for the data link. (Connect between DA and DB)

6. INSTALLING AND UNINSTALLING SOFTWARE PACKAGES

This chapter explains methods on how to install and uninstall software packages to run the board for each operating system.

6.1 Installing and Uninstalling Software Packages for Windows 95/98/NT 4.0

This section explains methods on how to install and uninstall software packages for Windows 95/98/NT 4.0.

6.1.1 Installing software packages for Windows 95/98/NT 4.0

The following shows the preparation before installation and installation procedure of software packages for Windows 95/98/NT 4.0.

Point
(1) If operating system is Windows NT 4.0, log on as a user whose privilege is an administrator.
(2) Remove all applications that are included in the Start up menu, then restart Windows before installing.
(3) The floppy diskettes, 1/5 (first disk) to 5/5 (5th disk) are used for installation.
(4) Uninstall SW0DNF-CCLINK, SW1DNF-CCLINK and SW2DNF-CCLINK before installing SW3DNF-CCLINK. Also, the utility setting needs to be configured again as all setting data using each utility is erased.
(5) SW3DNF-CCLINK performs installation from "Add/Delete Applications" in the "Control Panel." The other method is to execute "SETUP.EXE". When "SETUP.EXE" is clicked, installation begins starting from the sixth item.

(1) Preparation before installation (Required only when Windows 95 or 98 is used as OS)

The following explains the preparation procedure to be performed before installing the SW3DNF-CCLINK.

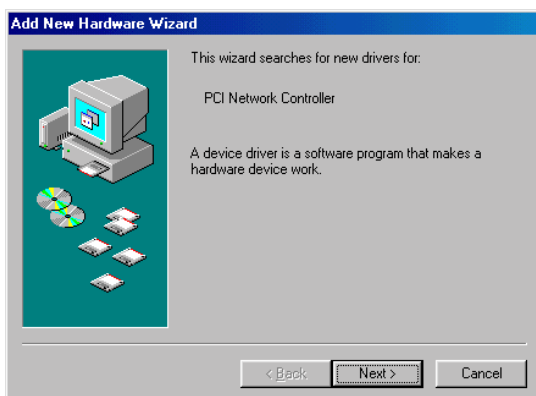

↓
(To the next page)

1. Turn on the power to the PC and start Windows.
2. When the screen shown to the left is displayed, click the [Next>] button.

(From the previous page)

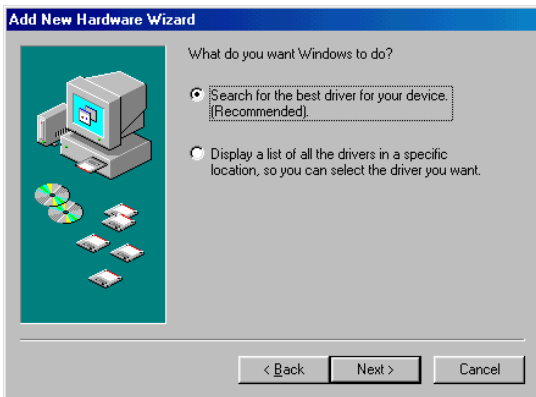

3. When the screen shown to the left is displayed, select "Search for the best driver for your device. (Recommended)," and then click the [Next>] button.



4. When the screen shown to the left is displayed, place a check in the "Specify a location" check box, then enter "A:\US" as the search location. When the setting is completed, insert the floppy disk marked "5/5" (fifth disk) into the floppy disk drive, and then click the [Next>] button.



5. The system searches for a device driver file. Click the [Next>] button.



6. The operation is complete when the screen shown to the left is displayed. Click the [Finish] button.

(2) Installing SW3DNF-CCLINK

Install SW3DNF-CCLINK according to the following procedure.

1. Turn on the power to the PC and start Windows.
2. Open "Start" – "Setting" – "Control Panel".

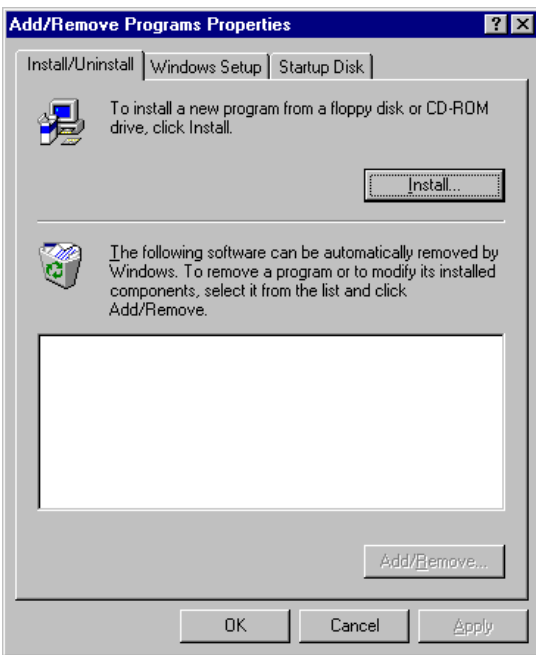

3. Open "Add/Remove Programs".
Click [Install . . .].



4. When the next screen is displayed, insert the 1/5 (first) floppy diskette into FDD.
After inserting the floppy diskette, click the [Next>] button.



(To the next page)

(From the previous page)

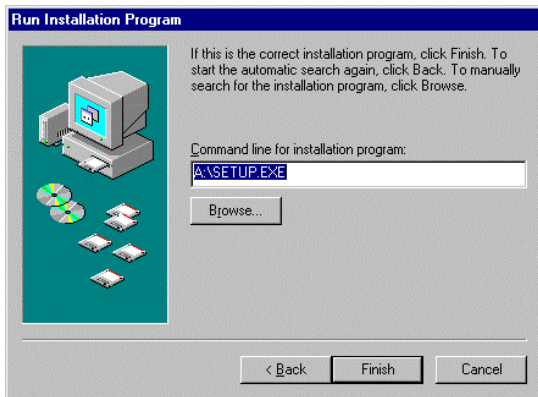

5. When the next screen is displayed, it indicates that "SETUP.EXE" is found. Click the [Finish] button, and start the installation.
If "SETUP.EXE" was not found, click the [Browse ...] button and change to the directory where "SETUP.EXE" is located.

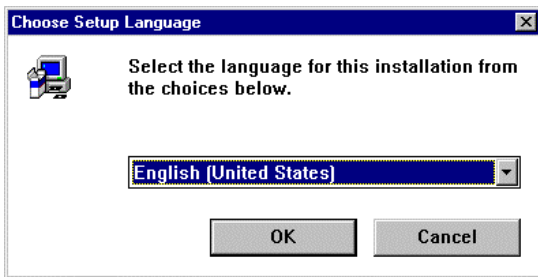

6. After a few moments, the screen similar to what shown left will be displayed. Select "English (United States)" and click the [OK] button.

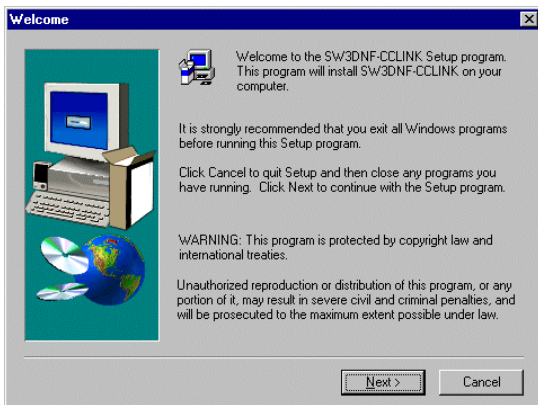

7. Verify the content, and click the [Next>] button.

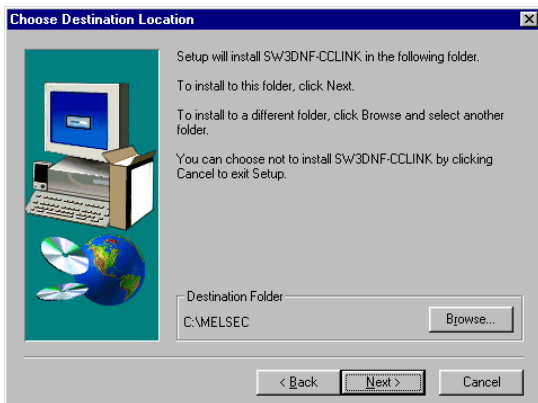

8. Specify the installation destination folder.
The default installation destination folder for SW3DNF-CCLINK is "C:\MELSEC".
If the default is fine, click the [Next>] button.
When changing the installation destination folder, click the [Browse] button and change it.



(To the next page)

(From the previous page)

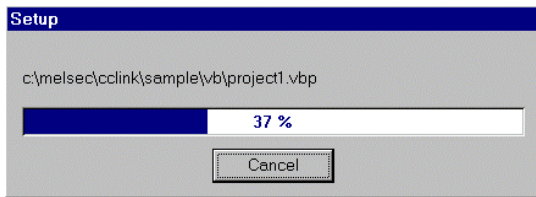

9. As the installation starts, follow the instructions and insert the floppy diskettes in order.

10. When the dialog box shown left is displayed, it indicates that installation is completed. To restart, verify that "Yes, I want to restart my computer now". is checked, then click the [Finish] button. To restart later, check "No, I will restart my computer later". and click the [Finish] button.

Point

- | |
|--|
| <p>(1) When the installation fails to complete successfully, and if software packages can be uninstalled, execute uninstallation.</p> <p>(2) When performing the re-installation, reinstall after performing the uninstallation.</p> |
|--|

6.1.2 Icons to be registered

Installing the software packages will register the icons shown below.

The icons shown below are registered in [Start] – [Program] – [MELSEC].

- (1)  MELSEC CC-Link Utility

Starts CC-Link Utility.

- (2)  Error viewer (for Windows 95/Windows98 only)

Starts Error viewer.

Point

- | |
|--|
| <p>(1) If other I/F board software packages are installed, the icon for the device monitor utilities may be registered.</p> <p>(2) If other I/F board software packages are installed, the board diagnosis utilities may be registered.
A80BDE-J61BT13 cannot use the board diagnosis utilities.</p> |
|--|

6.1.3 Uninstalling software packages for Windows 95/98/NT 4.0

The following shows uninstallation method for the software packages.

Point

Be sure to execute uninstallation from the control panel.
Do not directly start "UnInstaller.exe" that has been installed.



1. Select [Start] – [Settings] – [Control Panel] menu.
2. As control panel is displayed, double-click "Add/Remove Programs".



3. Select "SW3DNF-CCLINK", and click the [Add/Remove (R)] button.



(To the next page)

(From the previous page)

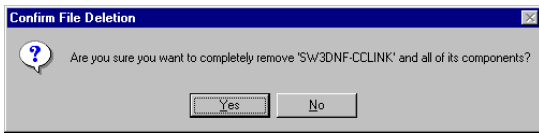

4. Clicking the [Yes] button starts uninstallation.

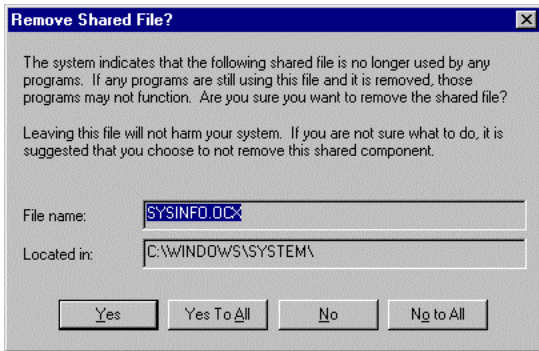

5. If the screen shown left is displayed, click [No to All] button. Clicking the [Yes] or [Yes to All] button deletes common files for the MELSEC software packages group, and other software packages may not start normally.

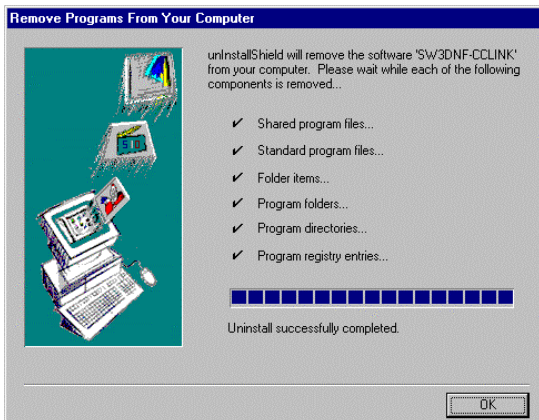

6. Upon completing uninstallation, click the [OK] button.

7. UTILITY OPERATION

Point

If the operating system is Windows NT4.0, use each utility after logging on as the user with an attribute of administrator.

7.1 Utility Common Operations

This section explains the common operations for each utility.

7.1.1 Starting a utility

An utility can be started by clicking on the following menus found in the [Start] – [Program] – [MELSEC] menu.

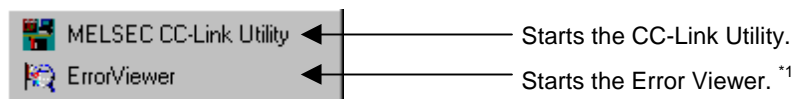

*1 : The error viewer is registered only when the operating system is Windows 95/98.

7.1.2 Starting the device monitor utility

The following explains how to start the device monitor utility from the CC-Link utility.

The device monitor utility can be started by clicking on the [Device Monitor] button found at the bottom of the CC-Link utility screen.

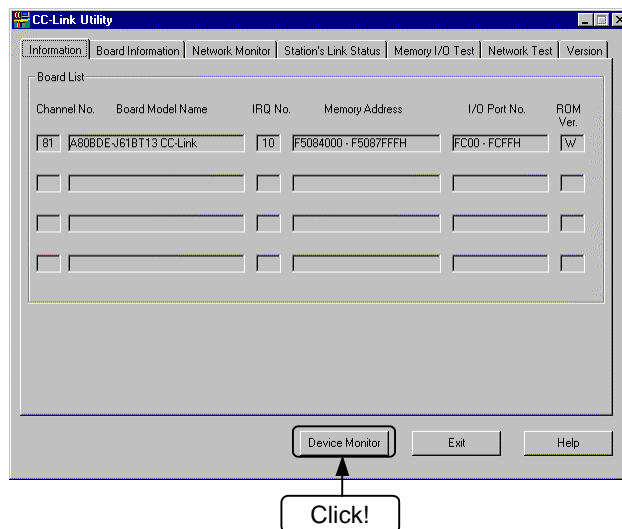

7.1.3 Ending an utility

This section explains how to end an utility.

- (1) To end the utility, click the [Exit] button at the bottom of the utility screen.

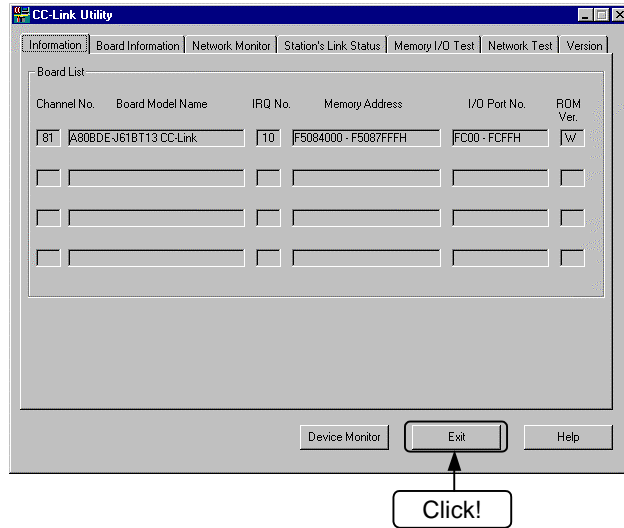

- (2) To end the device monitor utility, click [Menu] – [Exit] from the menu bar. When a dialog box is displayed, clicking the [Yes] button ends the device monitor utility.

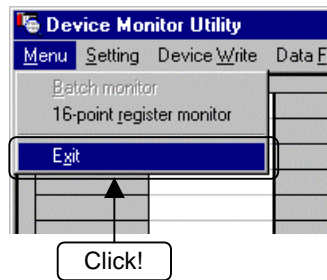

- (3) To end the error viewer, click [Log] – [Exit] menu from the menu bar.

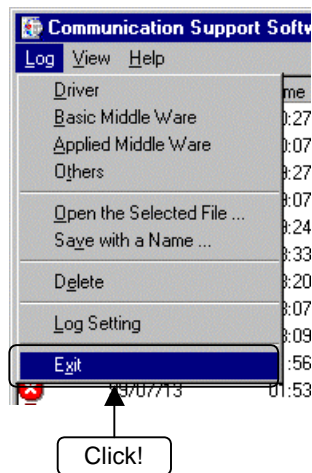

7.1.4 Displaying the help screen

This section explains how to display the utility's help screen.

- (1) To display the utility's help screen, click the [Help] button at the lower right-hand corner of the utility screen.

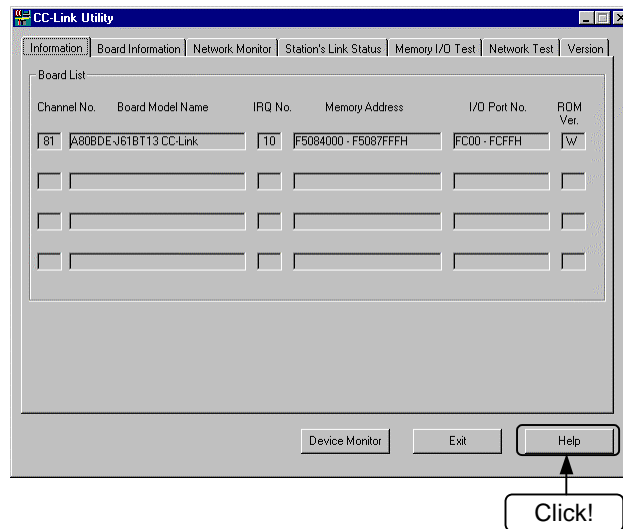

- (2) To display the help screen for the device monitor utility and error viewer, click [Help] – [Help] from the menu bar.

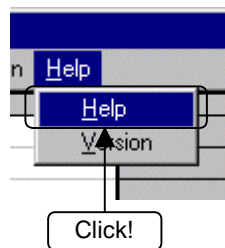

7.1.5 Verifying the version

This section explains how to verify the utility version.

- (1) To verify a utility's version, click the "Version" tab.

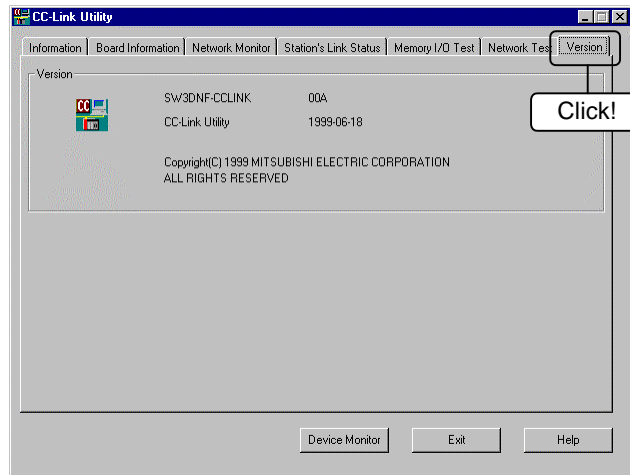

- (2) To verify the version for the device monitor utility and error viewer, click [Help] - [Version] from the menu bar.

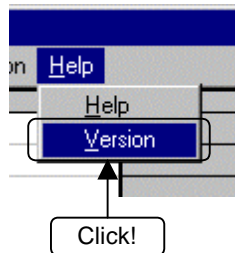

7.2 CC-Link Utility Operation

This section explains how to operate the CC-Link utilities.

7.2.1 Operation procedure

The following explains the operation procedure for the CC-Link utilities.

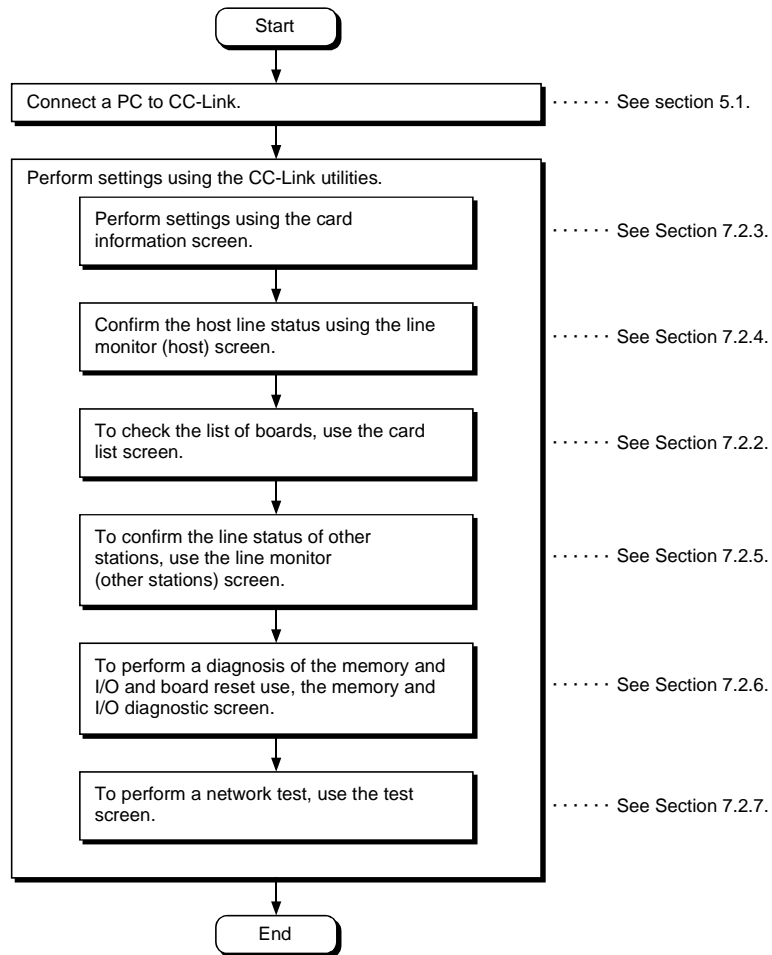

7.2.2 Card list screen operation

The hardware information that is set for I/F board is displayed.

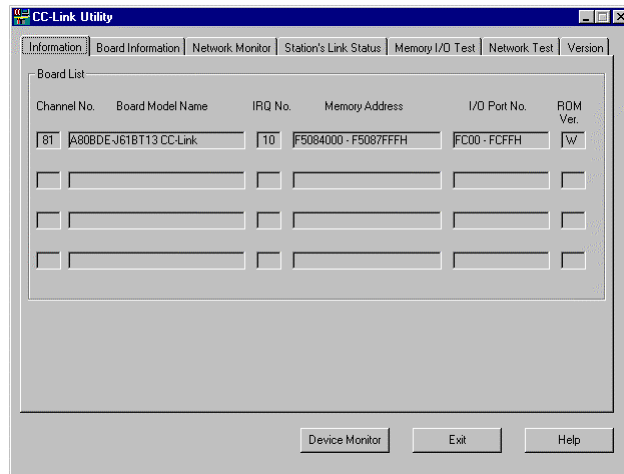

Item	Description
Channel No.	Displays the channel number.
Board Model Name	Displays the model of CC-Link board that is connected.
IRQ No.	Displays the IRQ number that I/F board uses.
Memory Address	Displays the range of dual-port memory that I/F board occupies.
I/O Port no.	Displays the ranges of I/O port that I/F board occupies.
ROM Ver.	Displays the ROM version of I/F board.

7.2.3 Operations on Card Information screen

The card information screen is used to set and to display various information about the installed I/F board.

Point
When switching screens, set the mode setting to "On-line" or "Off-line."

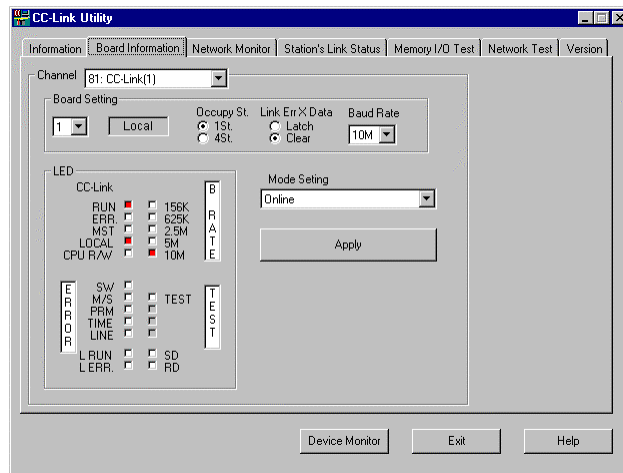

Item	Description	
Channel	Sets a channel to be used.	
Board Setting	Sets information on the host.	
	Item	Setting
	Station number	Station 1 to 64
	Number of stations occupied	1 station/4 stations
	Data entered at fault	Retain/clear
Transmission speed	156 k/625 k/2.5 M/5 M/10 Mbps	

Item	Description																																						
LED	<p>Display present status of I/F board.</p> <table border="1" data-bbox="699 360 1402 1072"> <thead> <tr> <th>LED name</th> <th>LED On</th> </tr> </thead> <tbody> <tr> <td>RUN</td> <td>CC-Link system normal</td> </tr> <tr> <td>ERR.</td> <td>Communication abnormal</td> </tr> <tr> <td>MST</td> <td>Master station</td> </tr> <tr> <td>LOCAL</td> <td>Local station</td> </tr> <tr> <td>CPU R/W</td> <td>Communicating</td> </tr> <tr> <td>SW</td> <td>Switch setting error</td> </tr> <tr> <td>M/S</td> <td>Master station duplication error</td> </tr> <tr> <td>PRM</td> <td>Parameter error</td> </tr> <tr> <td>TIME</td> <td>Time over</td> </tr> <tr> <td>LINE</td> <td>Cable disconnection error</td> </tr> <tr> <td>L RUN</td> <td>Data link running</td> </tr> <tr> <td>L ERR.</td> <td>Communication error</td> </tr> <tr> <td>156k</td> <td rowspan="5">LED for the set baud rate lights up</td> </tr> <tr> <td>625k</td> </tr> <tr> <td>2.5M</td> </tr> <tr> <td>5M</td> </tr> <tr> <td>10M</td> </tr> <tr> <td>TEST</td> <td>Off-line test executing</td> </tr> <tr> <td>SD</td> <td>Data transmitting</td> </tr> <tr> <td>RD</td> <td>Data receiving</td> </tr> </tbody> </table>	LED name	LED On	RUN	CC-Link system normal	ERR.	Communication abnormal	MST	Master station	LOCAL	Local station	CPU R/W	Communicating	SW	Switch setting error	M/S	Master station duplication error	PRM	Parameter error	TIME	Time over	LINE	Cable disconnection error	L RUN	Data link running	L ERR.	Communication error	156k	LED for the set baud rate lights up	625k	2.5M	5M	10M	TEST	Off-line test executing	SD	Data transmitting	RD	Data receiving
LED name	LED On																																						
RUN	CC-Link system normal																																						
ERR.	Communication abnormal																																						
MST	Master station																																						
LOCAL	Local station																																						
CPU R/W	Communicating																																						
SW	Switch setting error																																						
M/S	Master station duplication error																																						
PRM	Parameter error																																						
TIME	Time over																																						
LINE	Cable disconnection error																																						
L RUN	Data link running																																						
L ERR.	Communication error																																						
156k	LED for the set baud rate lights up																																						
625k																																							
2.5M																																							
5M																																							
10M																																							
TEST	Off-line test executing																																						
SD	Data transmitting																																						
RD	Data receiving																																						
Mode Setting	<p>Perform the mode setting for the I/F board, and display the present mode status.</p> <table border="1" data-bbox="699 1140 1402 1496"> <thead> <tr> <th>Mode</th> <th>Data</th> </tr> </thead> <tbody> <tr> <td>Online (automatic return yes)</td> <td>Used for normal communication</td> </tr> <tr> <td>Offline</td> <td>Becomes the state when not connected to the network.</td> </tr> <tr> <td>H/W test mode</td> <td>Executes a test of the A80BDE-J61BT13 hardware. [Procedure] Connect a terminal resistor between the terminal DA and DB. Set the mode setting to "H/W test mode" and press the "Update" button.</td> </tr> </tbody> </table>	Mode	Data	Online (automatic return yes)	Used for normal communication	Offline	Becomes the state when not connected to the network.	H/W test mode	Executes a test of the A80BDE-J61BT13 hardware. [Procedure] Connect a terminal resistor between the terminal DA and DB. Set the mode setting to "H/W test mode" and press the "Update" button.																														
Mode	Data																																						
Online (automatic return yes)	Used for normal communication																																						
Offline	Becomes the state when not connected to the network.																																						
H/W test mode	Executes a test of the A80BDE-J61BT13 hardware. [Procedure] Connect a terminal resistor between the terminal DA and DB. Set the mode setting to "H/W test mode" and press the "Update" button.																																						
"Apply" button	The contents of the setting with respect to the I/F board selected by the channel are updated.																																						

7.2.4 Operations on Line Monitor (host) screen

This screen monitors the line status of the host.

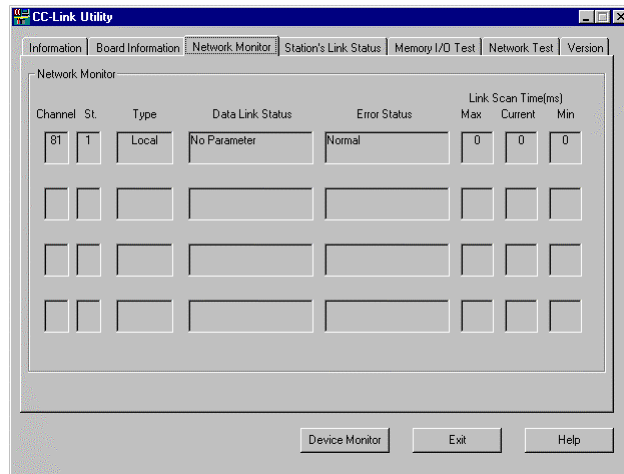

Item	Description																								
Channel	Displays the channel number.																								
St.	Displays the station number of the host.																								
Data Link Status	<p>Monitors and displays the startup status of the data link.</p> <table border="1"> <thead> <tr> <th>Status</th> <th>Contents</th> </tr> </thead> <tbody> <tr> <td>Initial status</td> <td>Data link is in initial status.</td> </tr> <tr> <td>No parameter</td> <td>Parameters have not been received.</td> </tr> <tr> <td>Data linking</td> <td>The data link is being executed.</td> </tr> <tr> <td>Data link stopping</td> <td>The data link has stopped.</td> </tr> <tr> <td>Disconnecting (Not polling)</td> <td>There is no inquiry from the master station and the link is disconnected.</td> </tr> <tr> <td>Disconnecting (Line Error)</td> <td>The link is disconnected due to an error in the line.</td> </tr> <tr> <td>Disconnecting (others)</td> <td>The link is disconnected due to other reasons.</td> </tr> <tr> <td>Line testing</td> <td>A line test is being performed.</td> </tr> <tr> <td>Parameter Set testing</td> <td>A test is being performed on the parameter settings from the master station.</td> </tr> <tr> <td>Automatic returning</td> <td>A return is automatically being processed.</td> </tr> <tr> <td>Resetting</td> <td>The board is being reset.</td> </tr> </tbody> </table>	Status	Contents	Initial status	Data link is in initial status.	No parameter	Parameters have not been received.	Data linking	The data link is being executed.	Data link stopping	The data link has stopped.	Disconnecting (Not polling)	There is no inquiry from the master station and the link is disconnected.	Disconnecting (Line Error)	The link is disconnected due to an error in the line.	Disconnecting (others)	The link is disconnected due to other reasons.	Line testing	A line test is being performed.	Parameter Set testing	A test is being performed on the parameter settings from the master station.	Automatic returning	A return is automatically being processed.	Resetting	The board is being reset.
Status	Contents																								
Initial status	Data link is in initial status.																								
No parameter	Parameters have not been received.																								
Data linking	The data link is being executed.																								
Data link stopping	The data link has stopped.																								
Disconnecting (Not polling)	There is no inquiry from the master station and the link is disconnected.																								
Disconnecting (Line Error)	The link is disconnected due to an error in the line.																								
Disconnecting (others)	The link is disconnected due to other reasons.																								
Line testing	A line test is being performed.																								
Parameter Set testing	A test is being performed on the parameter settings from the master station.																								
Automatic returning	A return is automatically being processed.																								
Resetting	The board is being reset.																								
Error Status	<p>Monitors and displays the error status.</p> <table border="1"> <thead> <tr> <th>Display</th> <th>Contents</th> </tr> </thead> <tbody> <tr> <td>Normal</td> <td>Normal status</td> </tr> <tr> <td>Transmission Error</td> <td>Error in communication path was detected.</td> </tr> <tr> <td>Parameter Error</td> <td>Error in parameters was detected.</td> </tr> <tr> <td>CRC Error</td> <td>CRC error was detected.</td> </tr> <tr> <td>Time Out Error</td> <td>Timeout error was detected.</td> </tr> <tr> <td>Abort Error</td> <td>An error in the CC-Link board (gate array) was detected.</td> </tr> <tr> <td>Setting Error</td> <td>Error in the setting was detected.</td> </tr> <tr> <td>Other Error</td> <td>Error arising from some other cause was detected.</td> </tr> </tbody> </table>	Display	Contents	Normal	Normal status	Transmission Error	Error in communication path was detected.	Parameter Error	Error in parameters was detected.	CRC Error	CRC error was detected.	Time Out Error	Timeout error was detected.	Abort Error	An error in the CC-Link board (gate array) was detected.	Setting Error	Error in the setting was detected.	Other Error	Error arising from some other cause was detected.						
Display	Contents																								
Normal	Normal status																								
Transmission Error	Error in communication path was detected.																								
Parameter Error	Error in parameters was detected.																								
CRC Error	CRC error was detected.																								
Time Out Error	Timeout error was detected.																								
Abort Error	An error in the CC-Link board (gate array) was detected.																								
Setting Error	Error in the setting was detected.																								
Other Error	Error arising from some other cause was detected.																								
Link Scan Time	Max	Displays the maximum value for the link scan time. (1 ms unit)																							
	Current	Displays the current value for the link scan time. (1 ms unit)																							
	Min	Displays the minimum value for the link scan time. (1 ms unit)																							

7.2.5 Operations on Line Monitor (other station) screen

Displays the line status of another station.

Point
The line monitor (other station) only monitors when the host status is "data linking."

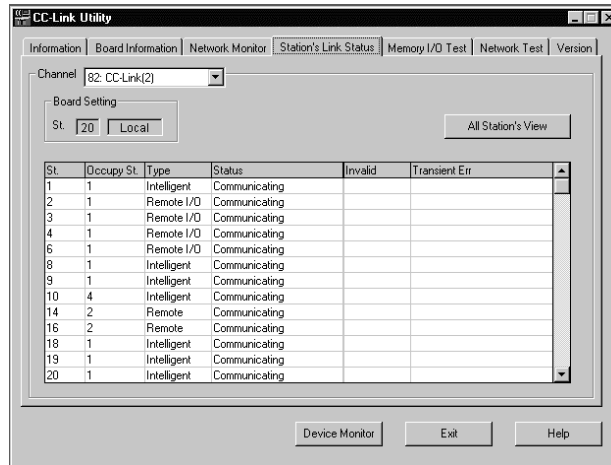

Item		Description															
Channel		Sets the channel to be used.															
Board Setting		Displays information on the host.															
Other Station Status	St.	Displays the station number that has been set.															
	Occupy St.	Displays the number of stations occupied.															
	Type	Displays the type of the station that is set. <table border="1" style="margin: 5px auto;"> <thead> <tr> <th>Display</th> <th>Contents</th> </tr> </thead> <tbody> <tr> <td>Remote Device</td> <td>Remote device station</td> </tr> <tr> <td>Remote I/O</td> <td>Remote I/O station</td> </tr> <tr> <td>Intelligent</td> <td>Intelligent station, local station</td> </tr> </tbody> </table>	Display	Contents	Remote Device	Remote device station	Remote I/O	Remote I/O station	Intelligent	Intelligent station, local station							
	Display	Contents															
	Remote Device	Remote device station															
	Remote I/O	Remote I/O station															
Intelligent	Intelligent station, local station																
Status	Displays the status of another station. <table border="1" style="margin: 5px auto;"> <thead> <tr> <th>Display</th> <th>Contents</th> </tr> </thead> <tbody> <tr> <td>Communicating</td> <td>Normal</td> </tr> <tr> <td>Communication interrupted</td> <td>Communication is stopped</td> </tr> <tr> <td>Link error</td> <td>There is a link error</td> </tr> <tr> <td>WDT error</td> <td>A watchdog timer error occurred</td> </tr> <tr> <td>Fuse brake off</td> <td>A station has blown a fuse</td> </tr> <tr> <td>Repeated station</td> <td>There are duplicate station numbers</td> </tr> <tr> <td>Moved switch</td> <td>Switch was changed</td> </tr> </tbody> </table>	Display	Contents	Communicating	Normal	Communication interrupted	Communication is stopped	Link error	There is a link error	WDT error	A watchdog timer error occurred	Fuse brake off	A station has blown a fuse	Repeated station	There are duplicate station numbers	Moved switch	Switch was changed
Display	Contents																
Communicating	Normal																
Communication interrupted	Communication is stopped																
Link error	There is a link error																
WDT error	A watchdog timer error occurred																
Fuse brake off	A station has blown a fuse																
Repeated station	There are duplicate station numbers																
Moved switch	Switch was changed																
Invalid	Displays the station with an error invalid. <table border="1" style="margin: 5px auto;"> <thead> <tr> <th>Display</th> <th>Contents</th> </tr> </thead> <tbody> <tr> <td>Error invalid station</td> <td>There is a setting</td> </tr> <tr> <td>(Free)</td> <td>No setting</td> </tr> </tbody> </table>	Display	Contents	Error invalid station	There is a setting	(Free)	No setting										
Display	Contents																
Error invalid station	There is a setting																
(Free)	No setting																
Transient Err	Displays the status of a transient error. <table border="1" style="margin: 5px auto;"> <thead> <tr> <th>Display</th> <th>Contents</th> </tr> </thead> <tbody> <tr> <td>Transient Error</td> <td>There is an error</td> </tr> <tr> <td>(Free)</td> <td>No error</td> </tr> </tbody> </table>	Display	Contents	Transient Error	There is an error	(Free)	No error										
Display	Contents																
Transient Error	There is an error																
(Free)	No error																

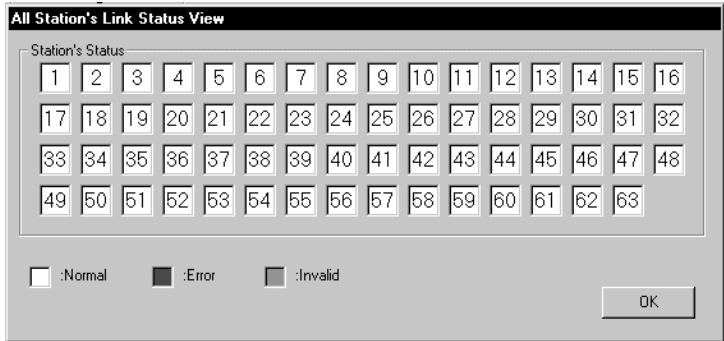
Item	Description
Other station communication status list	<p>A list of communication status for other stations is displayed.</p> <p>When a reserve station has been set in the data link parameter that is to set in the master station, the reserve station is displayed as a normal communication station in the following list of other station communication statuses.</p> 

7.2.6 Operations on Memory I/O Test screen

Diagnoses the dual-port memory and I/O port used by the CC-Link board.

Point
<p>(1) Start the diagnostic operation after disconnecting the external cable.</p> <p>(2) To switch the screens during the diagnostic operation, click the "Stop" button to terminate the diagnosis and then switch screens.</p>

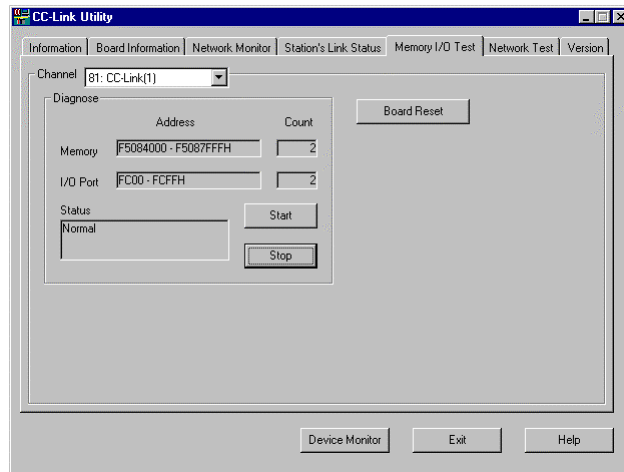

Item	Description
Channel	Set the channel to be used.
Diagnose	Displays the address being diagnosed and number of the diagnosis and status.
"Start" button	Starts the memory and I/O diagnosis.
"Stop" button	Terminates the memory and I/O diagnosis.
"Board Reset" button	Resets the CC-Link board.

7.2.7 Operation of the test screen

Tests the CC-Link board that is loaded.

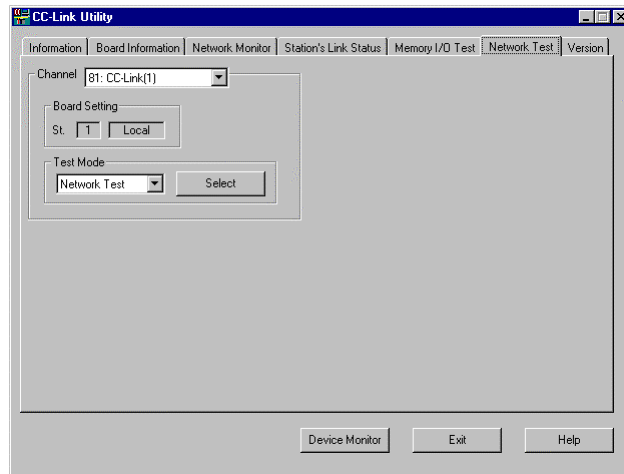

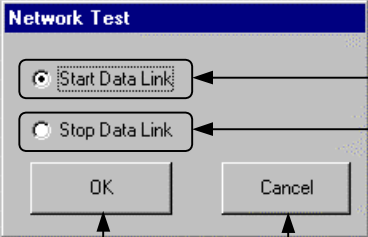
Item	Description				
Channel	Sets the channel to be used.				
Board Setting	Displays information on the host.				
Test Mode	Sets the items to be tested. <table border="1" data-bbox="699 1039 1401 1115" style="margin-left: 40px;"> <thead> <tr> <th data-bbox="705 1048 948 1084">Item</th> <th data-bbox="948 1048 1394 1084">Setting</th> </tr> </thead> <tbody> <tr> <td data-bbox="705 1084 948 1115">Network Test</td> <td data-bbox="948 1084 1394 1115">Performs a test for data link start and stop.</td> </tr> </tbody> </table>	Item	Setting	Network Test	Performs a test for data link start and stop.
Item	Setting				
Network Test	Performs a test for data link start and stop.				
"Start" button	The following dialog box is displayed by clicking. <div style="text-align: center;">  <p data-bbox="1091 1285 1366 1317">Select when starting data link.</p> <p data-bbox="1091 1335 1375 1366">Select when stopping data link.</p> <p data-bbox="740 1518 986 1550">Clicking this starts the test.</p> <p data-bbox="932 1491 1375 1523">Closes the dialog box without performing the test.</p> </div>				

7.3 Device Monitor Utility

This section explains how to operate and set the device monitor utility.

Point

In the device monitor utility, SB (special relay) and SW (special register) are indicated as SM and SD, respectively.

7.3.1 Operation procedure

The following explains how to operate the device monitor utility.

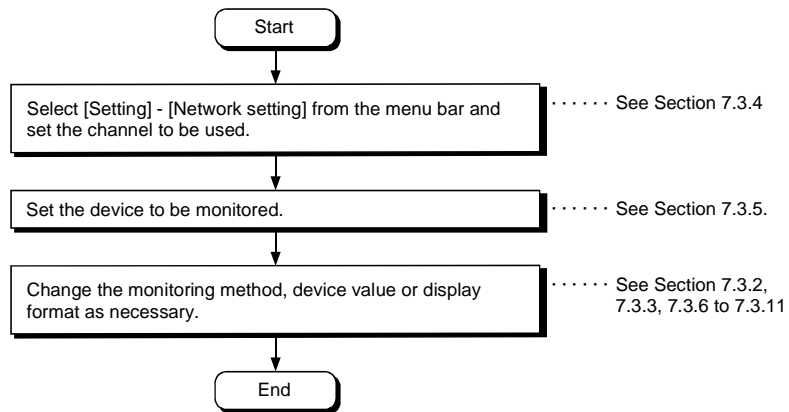

7.3.2 Setting as batch monitoring

Monitors only one device that has been specified.

(1) Selecting the menu

Select [Menu] – [Batch monitor] from the menu bar.
(Selectable for 16-point register monitor only.)

(2) Display screen

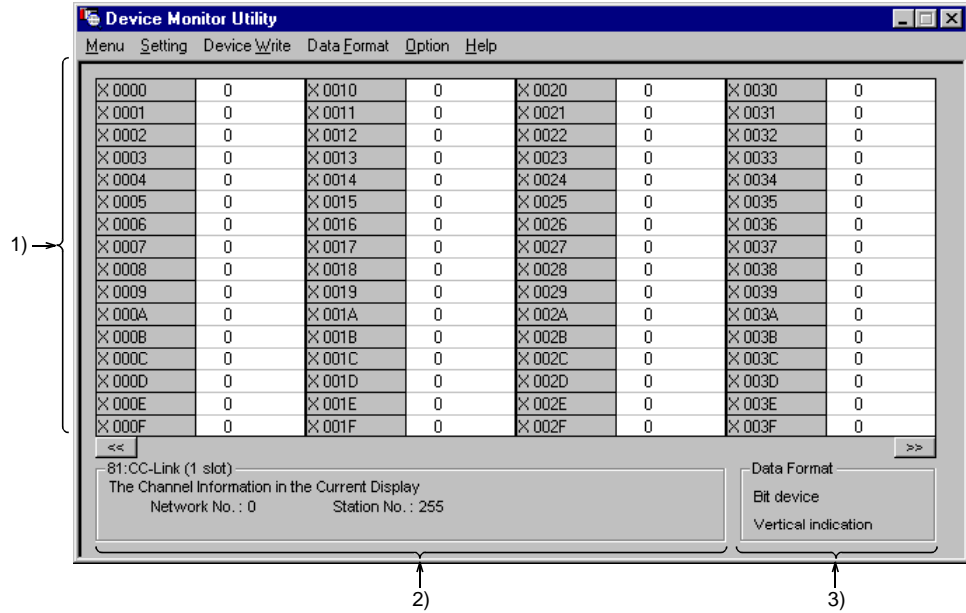

Item	Description
1) Device information	Displays the current device status. See Section 7.3.9 when the display form is changed.
2) Network status	Displays the network status currently set. See Section 7.3.4 when the network is set.
3) Data Format	Shows a display form and device types being displayed (word device and bit device). See Section 7.3.5 when the device type is changed. And, see Section 7.3.9 when the display form is changed.

7.3.3 Setting as 16 point register monitor

Monitors up to five bit devices and one word device simultaneously.

(1) Selecting the menu

Select [Menu] – [16 point register monitor] from the menu bar.
(Selectable at batch monitoring only.)

(2) Display screen

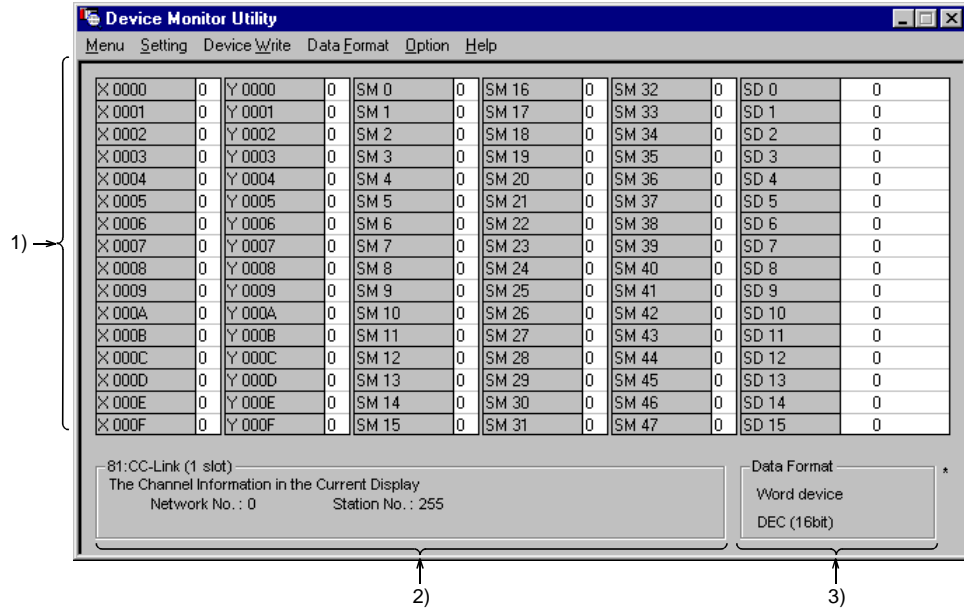

Item	Description
1) Device information	Displays the current device status. See Section 7.3.9 when changing the display form.
2) Network status	Displays the network status currently set. See Section 7.3.4 when setting the network.
3) Data Format	Shows a display form and device types being displayed (word device and bit device). See Section 7.3.5 when changing the device type. And, see Section 7.3.9 when changing the display form.

7.3.4 Setting the monitoring destination

Sets the network to be used for device monitoring.
Set this when starting the device monitor utility.

(1) Selecting the menu

Select [Setting] – [Network Setting] from the menu bar.

(2) Dialog box

Item	Description
Channel	Sets the channel to be used.
Network Setting	Sets the host and other stations along with network number and station number.
Logical Sta. No.	Sets the logical station number.

Point
Do not specify a CC-Link remote I/O station or intelligent device station as the monitor destination. Specifying a remote I/O station or intelligent device station generates a corresponding error.

7.3.5 Setting the device to monitor

Set the device to perform monitoring.

(1) Selecting the menu

Select [Setting] – [Device Setting] from the menu bar.

(2) Dialog box

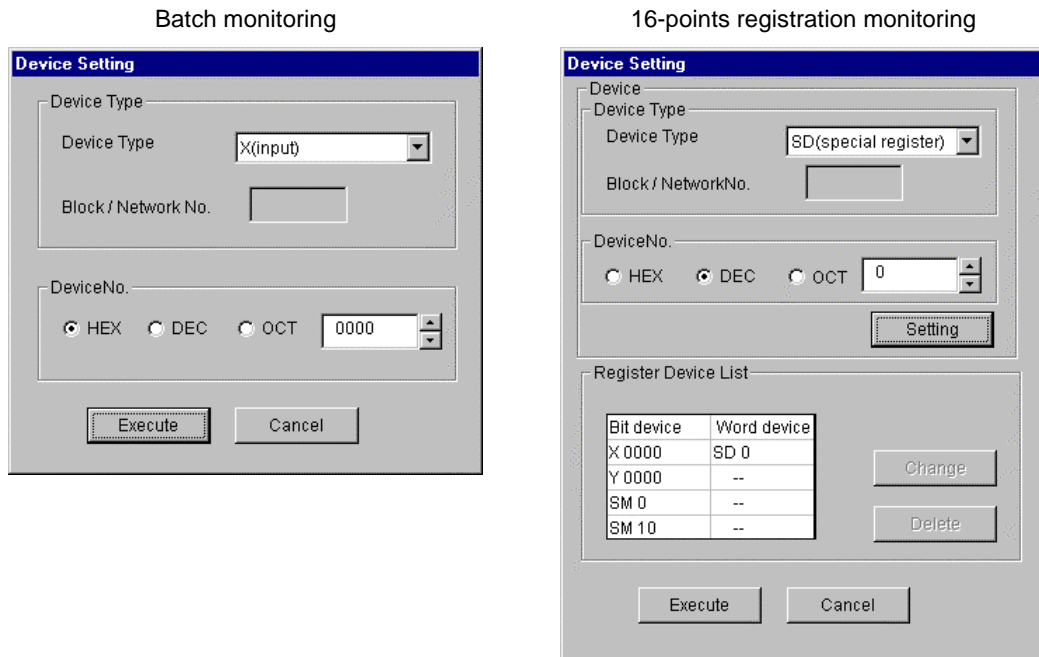

Item	Description																		
Device Type	Sets the device type, block number, and network number to monitor. And, to monitor the host station device on the CC-Link board, set as follows. <table border="1" style="margin: 10px auto;"> <thead> <tr> <th>Host station device to monitor</th> <th>Device type to specify</th> </tr> </thead> <tbody> <tr> <td>RX</td> <td>X</td> </tr> <tr> <td>RY</td> <td>Y</td> </tr> <tr> <td>SB</td> <td>SM</td> </tr> <tr> <td>SW</td> <td>SD</td> </tr> <tr> <td>RWw</td> <td>Ww</td> </tr> <tr> <td>Rwr</td> <td>Wr</td> </tr> <tr> <td>Random access buffer</td> <td>RAB</td> </tr> <tr> <td>Buffer memory</td> <td>SPB</td> </tr> </tbody> </table>	Host station device to monitor	Device type to specify	RX	X	RY	Y	SB	SM	SW	SD	RWw	Ww	Rwr	Wr	Random access buffer	RAB	Buffer memory	SPB
Host station device to monitor	Device type to specify																		
RX	X																		
RY	Y																		
SB	SM																		
SW	SD																		
RWw	Ww																		
Rwr	Wr																		
Random access buffer	RAB																		
Buffer memory	SPB																		
Device No.	Sets the head number of device to monitor. (HEX: Hexadecimal, DEC: Decimal, OCT : Octal)																		
Register Device List	Displays a list of the devices entered .																		
“Setting” button	Enters the data set in device type and device number, and adds them to register device list.																		
“Change” button	Selects the device to change, and click this button to change the entered data.																		
“Delete” button	Selects the device to be deleted, and click this button to delete from the register device list.																		

Point

The only devices that may be monitored using the 16-point entry monitor are those that have random access capability. If a device that is not capable of random-access is specified, a device type error (-3) will occur.
See Chapter 8, "ACCESSIBLE DEVICES AND RANGES," to determine whether or not a device has random-access capability.

7.3.6 Changing word device values

Changes the specified word device data.

(1) Selecting the menu

Select [Device Write] – [Data Changing] from the menu bar.

(2) Dialog box

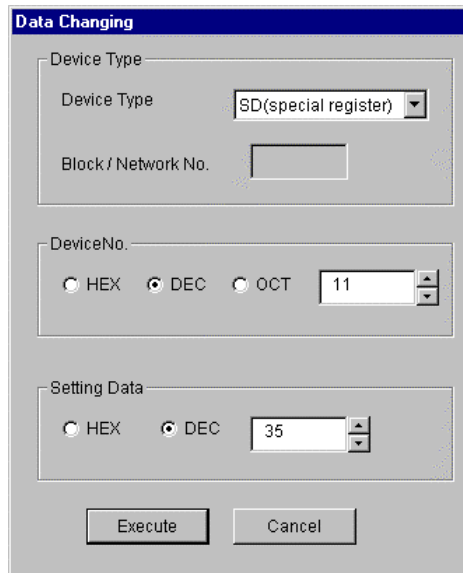

Item	Description
Device Type	Sets the device type, block number, and network number to change the data.
Device No.	Sets the device number to change the data. (HEX : Hexadecimal, DEC : Decimal, OCT : Octal)
Setting Data	Sets the data to be changed. (HEX : Hexadecimal, DEC : Decimal)



DANGER

- Configure the interlock circuit over the sequence program so that the entire system works safely at all times for data change control to the PLC in operation. Also, decide on corrective actions for an event of data communication error between the PC and PLC CPU in use.

7.3.7 Changing word device values continuously

Change the specified word device data for the number of specified points being set.

(1) Selecting the menu

Select [Device Write] – [Continuous Change in Data] from the menu bar.

(2) Dialog box

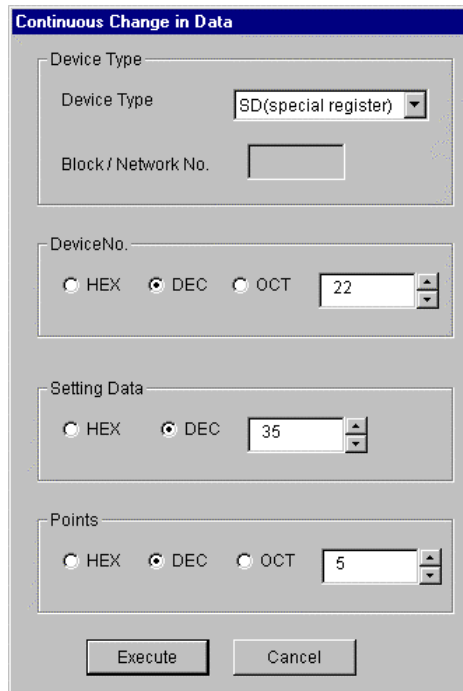

Item	Description
Device Type	Sets the device type, block number, and network number to change the data.
Device No.	Sets the head address to change the data. (HEX : Hexadecimal, DEC : Decimal, OCT : Octal)
Setting Data	Sets the data to be continuously changed. (HEX : Hexadecimal, DEC : Decimal)
Points	Sets the number of points to perform continuous change of the data. (HEX : Hexadecimal, DEC : Decimal, OCT : Octal)

⚠ DANGER

- Configure the interlock circuit over the sequence program so that the entire system works safely at all times for data change control to the PLC in operation. Also, decide on corrective actions for an event of data communication error between the PC and PLC CPU in use.

7.3.8 Tuning on/off a bit device

Turns on/off the specified bit device.

(1) Selecting the menu

Select [Device Write] – [Bit Device Setting (reset)] from the menu bar.

(2) Dialog box

Item	Description
Device Type	Sets the bit device type, block number, and network number to turn on/off.
Device No.	Sets the bit device number to turn on/off. (HEX : Hexadecimal, DEC : Decimal, OCT : Octal)

! DANGER

- Configure the interlock circuit over the sequence program so that the entire system works safely at all times for data change control to the PLC in operation. Also, decide on corrective actions for an event of data communication error between the PC and PLC CPU in use.

7.3.9 Switching the display form

Switches the display form for device monitor to the selected display form.

The batch monitoring and 16 point entry monitor have different sets of selectable menu.

(1) Selecting the menu

Select [Display switch] – [Word (Bit) Device] from the menu bar.

7.3.10 About the Numerical Input pad

By choosing [Option]-[Numerical Pad] on the menu bur, you can use the numerical pad when setting the device value, etc.

1. Click the numerical input column.

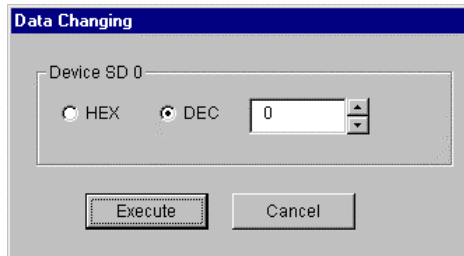

2. As the Numerical Pad appears, enter the value with the buttons. Then, click the "OK" button.

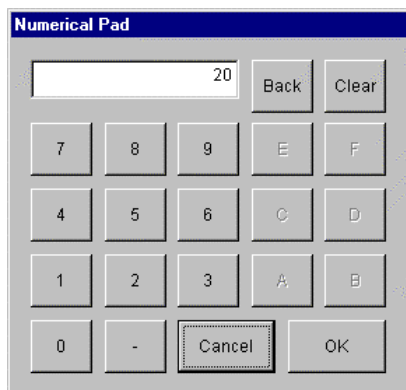

3. The value is entered.

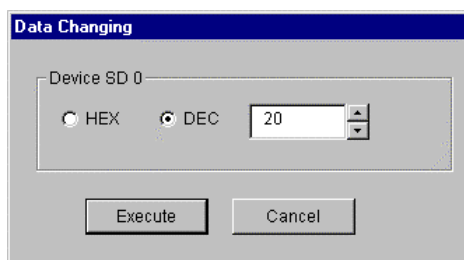

7.3.11 Other operations

Changing data in word device and turning on/off a bit device can be performed by double-clicking the device number on the screen while monitoring.

(1) Word device

The following shows the operation for changing a word device.
(Only when the display form is 16 bit.)

1. Double-click the number of the word device to be changed.

SD 20	0	SD 36
SD 21	0	SD 37
SD 22	0	SD 38
SD 23	0	SD 39
SD 24	0	SD 40
SD 25	0	SD 41
SD 26	0	SD 42

2. As the dialog box shown below is displayed, set any desirable value.
Then, click the [Execute] button.

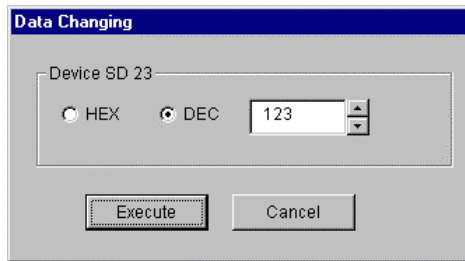

3. Select [Yes] in the dialog box shown below if the change is acceptable. Select [No] to cancel it.



DANGER

- Configure the interlock circuit over the sequence program so that the entire system works safely at all times for data change control to the PLC in operation. Also, decide on corrective actions for an event of data communication error between the PC and PLC CPU in use.

(2) Bit device

The following shows the operation for turning on/off a bit device.
However, this is operable only when the display form is "Portrait."

1. Double-click the number of the bit device to be changed.

X0014	0	X0024
X0015	0	X0025
X0016	0	X0026
X0017	0	X0027
X0018	0	X0028
X0019	0	X0029
X001A	0	X002A

2. Select [Yes] in the dialog box shown below, if the change is acceptable.
Select [No] to cancel it.

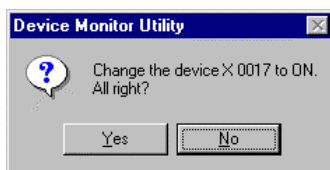
**DANGER**

- Configure the interlock circuit over the sequence program so that the entire system works safely at all times for data change control to the PLC in operation.
Also, decide on corrective actions for an event of data communication error between the PC and PLC CPU in use.

7.4 Error Viewer

This section explains how to operate or set the error viewer.

7.4.1 Screen description

The following explains the error viewer screen.

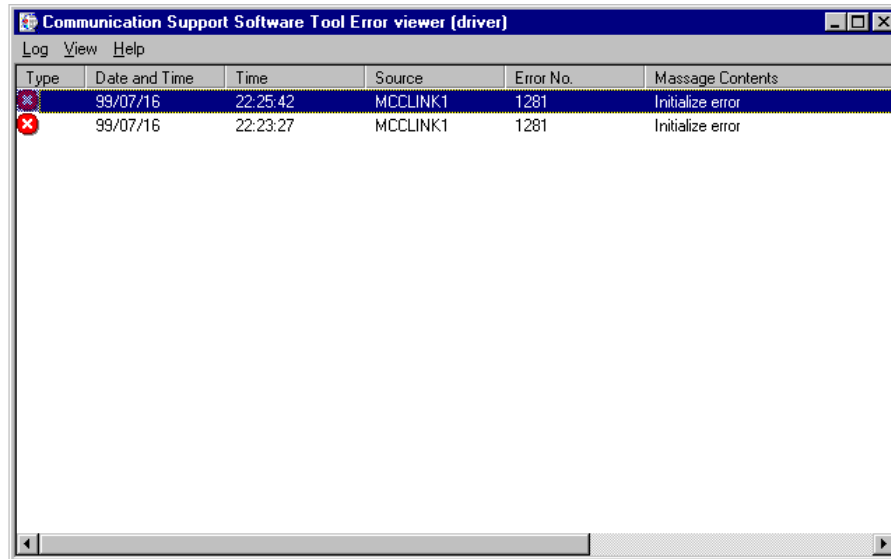

Item	Description
Type	<p>The error types are displayed by symbols shown below.</p> <ul style="list-style-type: none"> Normal message (Indicates comments that are generated from normal processing.) Warning message (Messages that are generated to elicit attention even though it is not an error.) Error message (Displays the error contents that are generated from each module. For the lines with this symbol, double-click to see the detailed message contents, and remove the cause promptly.)
Date and Time	Displays the date an error occurred.
Time	Displays the time an error occurred.
Source	Displays the source of an error.
Error No.	Displays the number for an error.
Message Contents	Displays the content of an error.

7.4.2 Log menu

The following explains the contents of log menu.

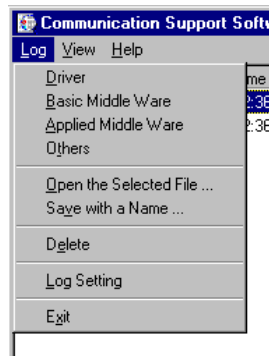

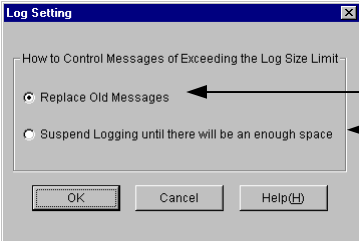
Item	Description
Selecting error-entry source type	Select the error-entry source type to be displayed in the error viewer. Driver Displays the messages generated by drivers such as common memory device. Basic Middle Ware Displays the messages generated by the common memory data server and tab control process. Applied Middle Ware Displays the messages generated by XMOP and OLEX. Others Displays the messages generated by the application packages.
Open the Selected File	Open the error log file (*.ELF).
Save with a Name	Save the error log data of the error entry source (driver, etc. ...) currently being selected to the specified file.
Delete	Erase the error log data of the error entry source (driver, etc. ...) currently being displayed. Perform operations according to direction displayed on the dialog box.
Log Setting	Select processing method for which the number of error logs exceeds the number of maximum entry. 
Exit	End the error viewer.

7.4.3 View menu

The following explains the contents of display menu.

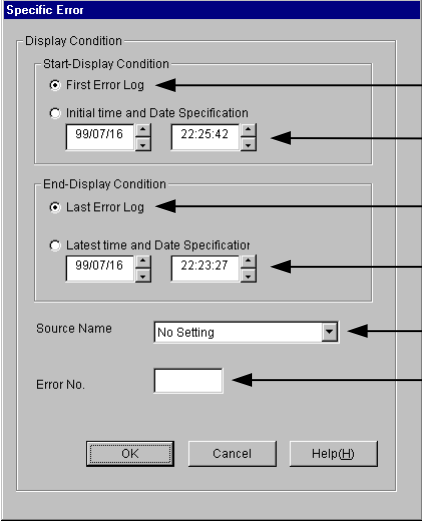
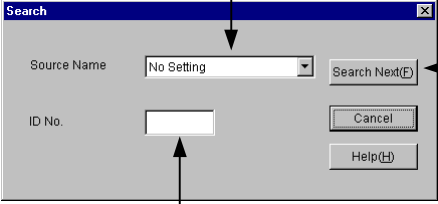

Item	Description
All Errors	Displays all the errors that occurred per type of error entry source.
Specific Error	<p>Sets the errors displayed on the screen according to the conditions in the dialog box shown below.</p>  <p>Start display from the first error log.</p> <p>Start error display from the specified date.</p> <p>Display logs up the last error log.</p> <p>Display errors up to the specified date.</p> <p>Display only the errors of a specified source.</p> <p>Display only error with the specified error No.</p>
Search	<p>Search error information of the source name and error code from the error log data currently being displayed using the dialog box shown below. (pressing the F3 key will display the same.)</p> <p>Set a source file name find.</p>  <p>Find the next error information.</p> <p>Input an error code to find.</p>

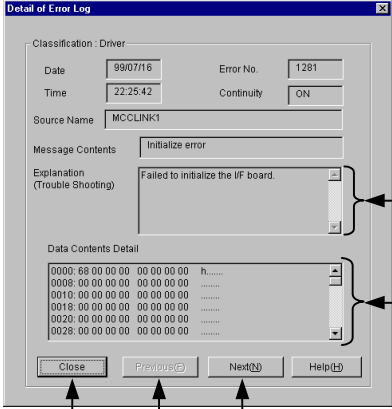
Item	Description
Detail	<p>Displays detailed information on the error log currently being selected. (pressing the Enter key after selecting a display item will display the same.)</p>  <p>Displays the details of the error. No details are given according to the type of the source.</p> <p>Displays when the contents of a driver or buffer memory are referenced. No data may be displayed according to the type of the source.</p> <p>Displays the details of the next error log information.</p> <p>Display the details of next error log information.</p> <p>Close this dialogue box.</p>
Renew	Updates the data currently being displayed.

8. ACCESSIBLE DEVICES AND RANGES

This chapter describes the devices and ranges that can be accessed during CC-Link communication.

8.1 Accessible Devices

The following lists the devices that can be accessed during CC-Link communication.

Point
The "Batch" in the following table indicates Batch Read and Batch Write. The "Random" in the table indicates Random Read, Random Write, Bit Set, or Bit Reset.

8.1.1 Host (personal computer (local station equivalent))

Device		Accessible/not accessible
X (RX)	Batch	○
	Random	
Y (RY)	Batch	○
	Random	
SB	Batch	○
	Random	
SW	Batch	○
	Random	
Ww (RWw)	Batch	○
	Random	
Wr (RWr)	Batch	○
	Random	
SPB (Host buffer memory)	Batch	○
	Random	
MRB (Host random access buffer)	Batch	○
	Random	

8.1.2 Other station

Device		Access destination						
		A1N	A0J2H A1S (-S1) A1SC24-R2 A1SH A1SJ (-S3) A1SJH (-S8) A2C (J) A2CC24 (-PRF) A2S (-S1) A2SH (-S1)	A2A (-S1) A2U (-S1) A2AS (-S1/S30) A2USH-S1 Q02 (H) -A Q06H -A	A3N A3A A3U	A4U	Q2A (-S1) Q3A Q4A Q4AR Q2AS (-S1) Q2ASH (-S1) Q02 (H) Q06H Q12H Q25H	Personal computer
X	Batch	○	○	○	○	○	○	×
	Random	○	○	○	○	○	○	×
Y	Batch	○	○	○	○	○	○	×
	Random	○	○	○	○	○	○	×
L	Batch	○	○	○	○	○	○	×
	Random	○	○	○	○	○	○	×
M	Batch	○	○	○	○	○	○	×
	Random	○	○	○	○	○	○	×
Special M (SM), SB	Batch	○	○	○	○	○	○	×
	Random	○	○	○	○	○	○	×
F	Batch	○	○	○	○	○	○	×
	Random	○	○	○	○	○	○	×
T (contact)	Batch	○	○	○	○	○	○	×
	Random	○	○	○	○	○	×	×
T (coil)	Batch	○	○	○	○	○	○	×
	Random	○	○	○	○	○	×	×
C (contact)	Batch	○	○	○	○	○	○	×
	Random	○	○	○	○	○	×	×
C (coil)	Batch	○	○	○	○	○	○	×
	Random	○	○	○	○	○	×	×
T (present value)	Batch	○	○	○	○	○	○	×
	Random	○	○	○	○	○	○	×
C (present value)	Batch	○	○	○	○	○	○	×
	Random	○	○	○	○	○	○	×
D	Batch	○	○	○	○	○	○	×
	Random	○	○	○	○	○	○	×
Special D (SD), SW	Batch	○	○	○	○	○	○	×
	Random	○	○	○	○	○	○	×
T (set value main)	Batch	○	○	○	○	○	×	×
	Random	×	×	×	×	×	×	×
T (set value sub 1)	Batch	×	×	○*1	○	○	×	×
	Random	×	×	×	×	×	×	×
T (set value sub 2)	Batch	×	×	×	×	○	×	×
	Random	×	×	×	×	×	×	×
T (set value sub 3)	Batch	×	×	×	×	○	×	×
	Random	×	×	×	×	×	×	×

*1 : A2A(-S1) cannot be accessed.

Device		Access destination						
		A1N	A0J2H A1S (-S1) A1SC24-R2 A1SH A1SJ (-S3) A1SJH (-S8) A2C (J) A2CC24 (-PRF) A2S (-S1) A2SH (-S1)	A2A (-S1) A2U (-S1) A2AS (-S1/S30) A2USH-S1 Q02 (H) -A Q06H -A	A3N A3A A3U	A4U	Q2A (-S1) Q3A Q4A Q4AR Q2AS (-S1) Q2ASH (-S1) Q02 (H) Q06H Q12H Q25H	Personal computer
C (set value main)	Batch	○	○	○	○	○	x	x
	Random	x	x	x	x	x		
C (set value sub 1)	Batch	x	x	○ *1	○	○	x	x
	Random			x	x	x		
C (set value sub 2)	Batch	x	x	x	x	○	x	x
	Random					x		
C (set value sub 3)	Batch	x	x	x	x	○	x	x
	Random					x		
A	Batch	○	○	○	○	○	x	x
	Random	○	○	○	○	○		
Z	Batch	○	○	○	○	○	○	x
	Random	○	○	○	○	○		
V (index register)	Batch	○	○	○	○	○	x	x
	Random	○	○	○	○	○		
R (file register)	Batch	x	○	○	○	○	○	x
	Random	x	○	○	○	○		
ER (extended file register)	Batch	x	○	○	○	○	○	x
	Random	x	○	○	○	○		
B	Batch	○	○	○	○	○	○	x
	Random	○	○	○	○	○		
W	Batch	○	○	○	○	○	○	x
	Random	○	○	○	○	○		
Q/QnA link special relay (within Q/QnA CPU)	Batch	x	x	x	x	x	○	x
	Random	x	x	x	x	x		
Retentive timer (contact)	Batch	x	x	x	x	x	○	x
	Random	x	x	x	x	x	x	
Retentive timer (coil)	Batch	x	x	x	x	x	○	x
	Random	x	x	x	x	x	x	
Q/QnA link special register (within Q/QnA CPU)	Batch	x	x	x	x	x	○	x
	Random	x	x	x	x	x		
Q/QnA edge relay (within Q/QnA CPU)	Batch	x	x	x	x	x	○	x
	Random	x	x	x	x	x		
Host random-access buffer	Batch	x	x	x	x	x	x	x
	Random	x	x	x	x	x		
Retentive timer (present value)	Batch	x	x	x	x	x	○	x
	Random	x	x	x	x	x		
Host link register (for transmission)	Batch	x	x	x	x	x	x	x
	Random	x	x	x	x	x		
Host link register (for reception)	Batch	x	x	x	x	x	x	x
	Random	x	x	x	x	x		
Q/QnA SEND function (Arrival acknowledgment)	Batch	x	x	x	x	x	x	x
	Random	x	x	x	x	x		

*1 : A2A(-S1) cannot be accessed.

Device		Access destination						
		A1N	A0J2H A1S (-S1) A1SC24-R2 A1SH A1SJ (-S3) A1SJH (-S8) A2C (J) A2CC24 (-PRF) A2S (-S1) A2SH (-S1)	A2A (-S1) A2U (-S1) A2AS (-S1/S30) A2USH-S1 Q02 (H) -A Q06H -A	A3N A3A A3U	A4U	Q2A (-S1) Q3A Q4A Q4AR Q2AS (-S1) Q2ASH (-S1) Q02 (H) Q06H Q12H Q25H	Personal computer
Q/QnA SEND function (Arrival acknowledgment)	Batch							
	Random	x	x	x	x	x	x	x
Direct link input	Batch	x	x	x	x	x	○	x
	Random							
Direct link output	Batch	x	x	x	x	x	○	x
	Random							
Direct link relay	Batch	x	x	x	x	x	○	x
	Random							
Direct link register	Batch	x	x	x	x	x	○	x
	Random							
Direct link special relay (network module side)	Batch	x	x	x	x	x	○	x
	Random							
Direct link special register (network module side)	Batch	x	x	x	x	x	○	x
	Random							
Special direct buffer register	Batch	x	x	x	x	x	○	x
	Random						x	
Other station buffer memory *1	Batch	○	○	○	○	○	○	○
	Random	x	x	x	x	x	x	x
Other station random access buffer	Batch	○	○	○	○	○	○	○
	Random	x	x	x	x	x	x	x
Other station RX *1	Batch	○	○	○	○	○	○	○
	Random	x	x	x	x	x	x	x
Other station RY *1	Batch	○	○	○	○	○	○	○
	Random	x	x	x	x	x	x	x
Other station link register	Batch	○	○	○	○	○	○	○
	Random	x	x	x	x	x	x	x
Other station SB *1	Batch	○	○	○	○	○	○	○
	Random	x	x	x	x	x	x	x
Other station SW *1	Batch	○	○	○	○	○	○	○
	Random	x	x	x	x	x	x	x

*1 : Access to the CC-Link (intelligent device station) module buffer memory installed into each CPU.

8.2 Accessible Range

The range of access during CC-Link communication includes only the module master station, local station PLC and the intelligent device station for the CC-Link connected by the I/F board, and PC with I/F board installed.

9. MELSEC DATA-LINK LIBRARY

This chapter describes the functional overview of the functions included in the library.

9.1 Overview of the MELSEC Data-Link Library

These functions are used when creating a user program that communicates with a PLC CPU. With the functions, the user can perform communication without being conscious of the hardware type on the opposite side or the communication protocol.

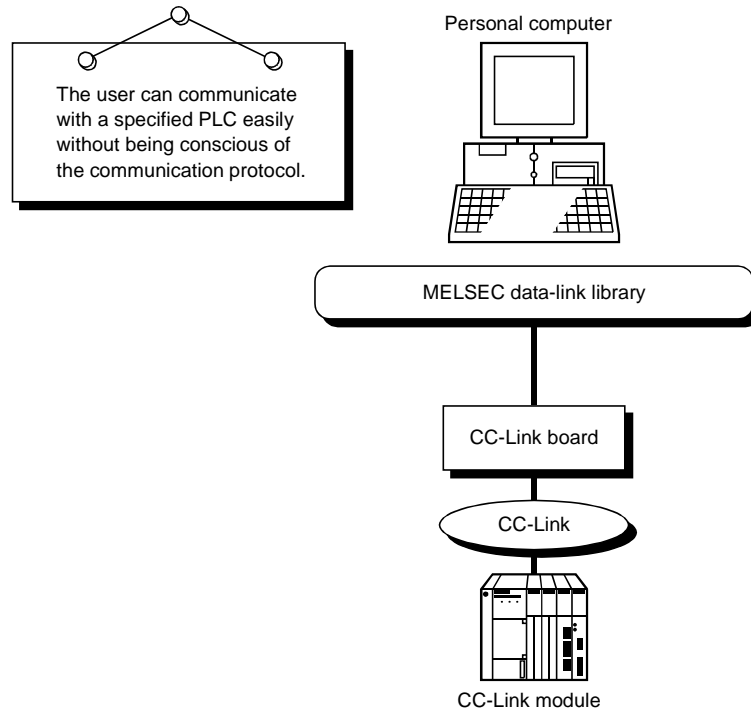

9.2 Function List

The following table lists the functions comprising the MELSEC data-link library that is provided with the software package.

Function name	Description
mdOpen	Opens a communication line.
mdClose	Closes a communication line.
mdSend	Performs batch write of devices.
mdReceive	Performs batch read of devices.
mdRandW	Writes devices randomly.
mdRandR	Reads devices randomly.
mdDevSet	Sets a bit device.
mdDevRst	Resets a bit device.
mdTypeRead	Reads the type of PLC CPU.
mdControl	Remote RUN/STOP/PAUSE
mdInit	Refreshes the PLC device address.
mdBdRst	Resets the board itself.
mdBdModSet	Sets the board itself.
mdBdModRead	Reads the board itself.
mdBdLedRead	Reads the LED information of the board itself.
mdBdSwRead	Reads the switch status of the board itself.
mdBdVerRead	Reads the version information of the board itself.

Point

For details of the functions, see HELP on MELSEC communication functions provided in the software package.

The HELP on MELSEC communication functions can be found in the following directory.

```

C:\ —— <MELSEC>
      |
      |—— <DrvCommon>
            |
            |—— <Help> —— Mdfunc.hlp
  
```

9.3 Settings for Using Functions

This section explains the setting procedure in order to use functions.

9.3.1 When using Visual Basic 5.0 and Visual Basic 6.0

The following describes the setting procedure when using Visual Basic 5.0 and Visual Basic 6.0.

1. Start Visual Basic 5.0 and Visual Basic 6.0 and select [Project] – [Add standard module] menu.
2. Select the "Existing files" tab and select "MDFUNC.BAS."
"MDFUNC.BAS" has been saved in the following directory during installation:
<User-specified folder> – <COMMON> – <INCLUDE>

9.3.2 When using Visual C++ 5.0 and Visual C++ 6.0

The following describes the setting procedure when using Visual C++ 5.0 and Visual Basic 6.0.

(1) When setting an include file

1. Start Visual C++ 5.0 and Visual C++ 6.0 and select [Tool] – [Option] menu.
2. Select the "Directory" tab and set the directory type to "Include files."
3. Double-click the item to set and reference the include file.
"MDFUNC.H" has been saved in the following directory during installation:
<User-specified folder> – <COMMON> – <INCLUDE>
4. Add "#include<mdfunc.h>" at the beginning of your program.

(2) When setting a library file

1. Start Visual C++ 5.0 and Visual C++ 6.0 and select [Tool] – [Option] menu.
2. Select the "Directory" tab and set the directory type to "Library files" in the same manner as in (1).
3. Open the workspace to create and select [Project] – [Set].
4. Select the "Link" tab, set "General" as the category, then type "mdfunc32.lib" in the object/library module field.

9.4 Procedure for Programming

The following describes the procedure for programming using the MELSEC data-link library. In this section, it is assumed that the software package has already been installed.

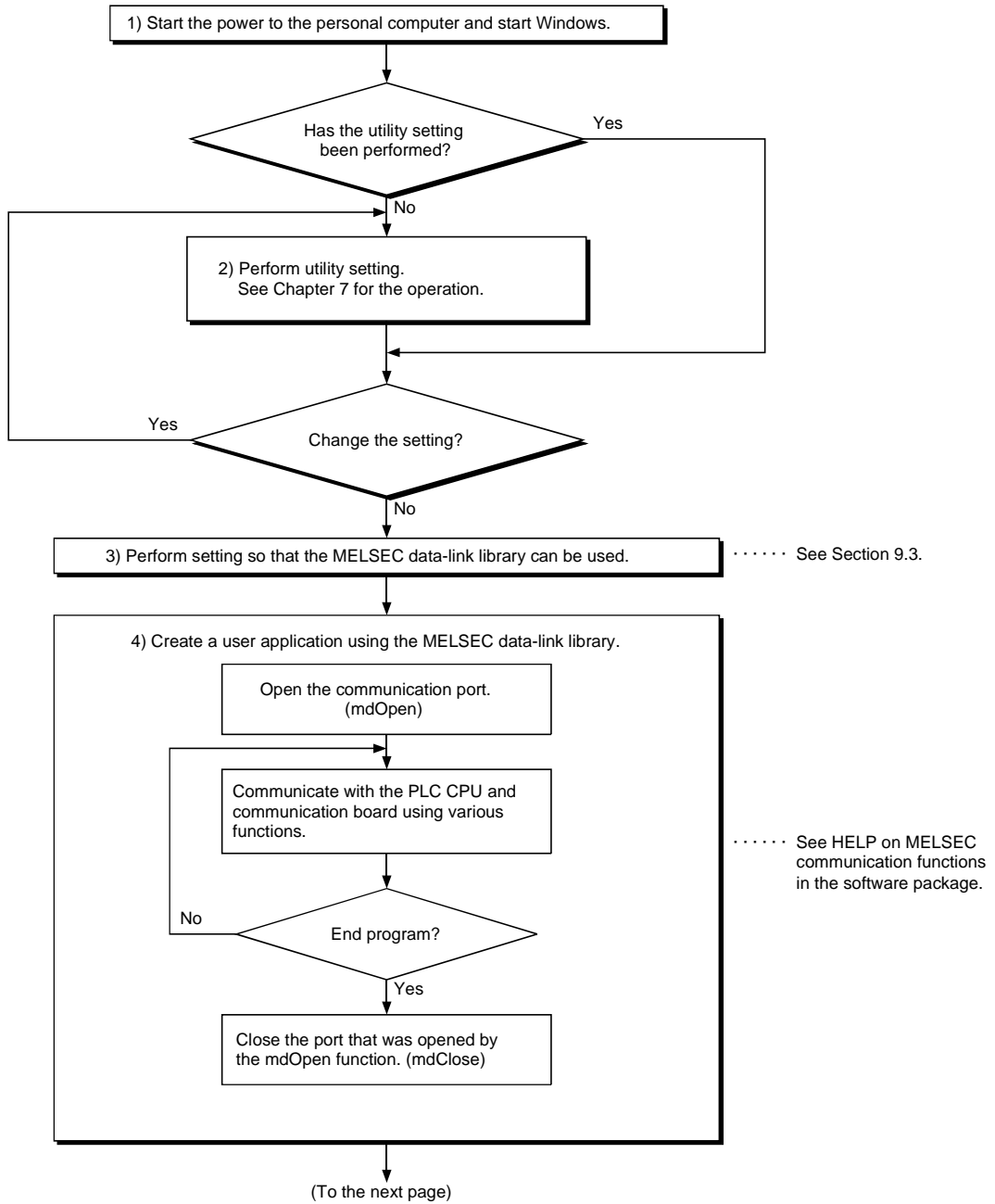

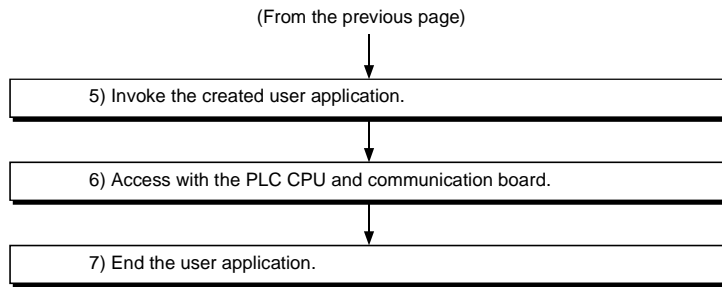

Point	<p>Perform the processing for opening and closing a communication line (mdOpen / mdClose) only once at the beginning and end of a program. Repeating opening and closing of a communication line for each transaction will degrade the communication performance.</p> <p>When accessing the PLC CPU and communication board again with the user created application program, they can be accessed by performing steps 5) to 7) only.</p>
--------------	---

9.5 Channel

The following is the channel used by the MELSEC data library:

Number	Channel name	Description
81 to 84	CC-Link (1st board to 4th board)	This is used when communication via the CC-Link board. This is set using the BD No. DIP switch on the back of the CC-Link board. The following will be set using the SW1 and SW2 settings. 81: OFF, OFF 82: ON, OFF 83: OFF, ON 84: ON, ON

9.6 Station Number Settings

The following lists the station numbers specified via functions.

Communication	Station number specification
CC-Link	Host: 255 (0xFF) Other station: 0 to 64(0x40) *3

9.7 Device Types

Either code number or device name can be specified for functions as the device type.

(1) Only when via I/F board

The following table shows the CC-Link dedicated device type when accessing to the device via I/F board.

Device type			Device
Code specification		Device name specification	
Decimal	Hexadecimal		
1	1H	Dev X	Host RX
2	2H	Dev Y	Host RY
5	5H	Dev SM	Host SB (link special B for CC-Link)
14	EH	Dev SD	Host SW (link special W for CC-Link)
33	21H	Dev MRB	Host random access buffer
36	24H	Dev Ww	Host link register (for transmitting)
37	25H	Dev Wr	Host link register (for receiving)
50	32H	Dev SPB	Host buffer memory
32768	8000H	Dev RBM	Other buffer memory *1
32800	8020H	Dev RAB	Other random access buffer *1
32801	8021H	Dev RX	Other RX *1
32802	8022H	Dev RY	Other RY *1
32804	8024H	Dev RW	Other link register *1
32867	8063H	Dev SB	Other SB (link special; B for CC-Link) *1
32868	8064H	Dev SW	Other SW (link special; W for CC-Link) *1

*1 : Cannot use with mdRandR, mdRandW, mdDevSet and mdDevRst functions.

(2) Common

The following table shows the common device type for all communication course.

Device type			Device
Code specification		Device name specification	
Decimal	Hexadecimal		
1	1 _H	DevX	X
2	2 _H	DevY	Y
3	3 _H	DevL	L
4	4 _H	DevM	M
5	5 _H	DevSM	Special M (SM), SB (link special B for MNET/10)
6	6 _H	DevF	F
7	7 _H	DevTT	T (contact)
8	8 _H	DevTC	T (coil)
9	9 _H	DevCT	C (contact)
10	A _H	DevCC	C (coil)
11	B _H	DevTN	T (present value)
12	C _H	DevCN	C (present value)
13	D _H	DevD	D
14	E _H	DevSD	Special D (SD), SW (link special W for MNET/10)
15	F _H	DevTM	T (set value main)
16	10 _H	DevTS	T (set value sub 1)
16002	3E82 _H	DevTS2	T (set value sub 2)
16003	3E83 _H	DevTS3	T (set value sub 3)
17	11 _H	DevCM	C (set value main)
18	12 _H	DevTS	C (set value sub 1)
18002	4652 _H	DevTS2	C (set value sub 2)
18003	4653 _H	DevTS3	C (set value sub 3)
19	13 _H	DevA	A
20	14 _H	DevZ	Z
21	15 _H	DevV	V (index register)
22	16 _H	DevR	R (file register)
22001 to 22256	55F1 _H to 56F0 _H	DevER to DevER256	ER (extension file register)
23	17 _H	DevB	B
24	18 _H	DevW	W
25	19 _H	DevQSB	Q/QnA link special relay (within the Q/QnA CPU)
26	1A _H	DevSTT	Retentive timer (contact)
27	1B _H	DevSTC	Retentive timer (coil)
28	1C _H	DevQSW	Q/QnA link special register (within the Q/QnA CPU)
30	1E _H	DevQV	Q/QnA edge relay (within the Q/QnA CPU)

Device type			Device
Code specification		Device name specification	
Decimal	Hexadecimal		
33	21 _H	DevMRB	Host random access buffer *1
35	23 _H	DevSTN	Retentive timer (present value)
36	24 _H	DevWw	Host link register (for transmitting) *1
37	25 _H	DevWr	Host link register (for receiving) *1
40	28 _H	DevFS	FXCPU S-device
50	32 _H	DevSPB	Host buffer memory *1
101	65 _H	DevMAIL	Q/QnA SEND/RECV function (Arrival acknowledgment)
102	66 _H	DevMAILNC	Q/ QnA SEND/RECV function (No arrival acknowledgment)
1001 to 1255	3E9 _H to 4E7 _H	DevLX1 to DevLX255	Direct link input
2001 to 2255	7D1 _H to 8CF _H	DevLY1 to DevLY255	Direct link output
23001 to 23255	59D9 _H to 5AD7 _H	DevLB1 to DevLB255	Direct link relay
24001 to 24255	5DC1 _H to 5EBF _H	DevLW1 to DevLW255	Direct link register
25001 to 25255	61A9 _H to 62A7 _H	DevLSB1 to DevLSB255	Direct link special relay (network module side)
28001 to 28255	6D61 _H to 6E5F _H	DevLSW1 to DevLSW255	Direct link special register (network module side)
29000 to 29255	7148 _H to 7247 _H	DevSPGO to DevSPG255	Special direct buffer register
31000 to 31255	7918 _H to 7A17 _H	DevEMO to DevEM255	EM (shared device)
32000 to 32255	7D00 _H to 7DFF _H	DevEDO to DevED255	ED (shared device)

*1 : Dedicated device for accessing the buffer memory for the I/F board (host).

10. ERROR CODE

An error code is returned as the return value when a function is executed.

The error definition and corrective action that correspond to each error code are described.

Return value (HEX)	Error definition	Corrective action
0	Normal completion	
1	Driver not started The driver has not been started. The interrupt number/I/O address are overlapping with other board.	Correct the error occurred during driver startup. Check the board setting.
2	Board response error Time out has occurred while waiting for a response to the corrective action.	Check the operation status of the access station(s) and loading condition of the board(s). Retry in an application program.
65 (41)	Channel error An unregistered channel number was specified.	Check the channel number.
66 (42)	OPEN error The specified channel has already been opened.	Open only once.
67 (43)	CLOSE error The specified channel has already been closed.	Close only once.
68 (44)	PATH error A path other than the opened line was set.	Specify the station with an open path.
69 (45)	Processing code error An unsupported processing code was issued.	Use the supported processing code.
70 (46)	Station specification error The specified station is incorrect. A process that should have been requested to other station was requested to the host. Or, the station number corresponds to the host (0xFF) but the network number is not 0.	Correct the specification of the station number in the application program.
71 (47)	Reception data error (during RECV request) Data has not been received.	Wait until data is received.
72 (48)	Waiting for mode setting Mode setting has not been performed.	Perform mode setting.
73 (49)	Mode error Processing was requested to other station when the mode setting was not online.	Set the mode to online. Or, cancel the request.
	Interrupt number error The interrupt number is overlapping with other board.	Check the board setting.
	I/O address error The I/O address is overlapping with other board.	
77 (4D)	Memory error Enough memory could not be secured.	Terminate other application(s) currently running. Check if the system is operating normally. Reboot the system.
78 (4E)	Time out error during mode setting Mode setting was attempted but failed due to time out.	Restart after checking that the dual-port memory is not overlapping with other board. Hardware fault.
79 (4F)	S/W setting data error Incorrect data was found in the argument parameter when setting S/W.	Check the argument parameter of S/W setting data.
80 (50)	Unsuccessful mapping of common memory address.	Check if the common address is overlapping with other I/F board.
81 (51)	Channel response error at source (When a SEND request is issued) Received an abnormal response to the SEND request.	Retry. Check if the system is operating normally. Reboot the system.
85 (55)	Channel number error (during RECV request) A channel number error.	Check the channel number used during the RECV request.
100 (64)	Accessing host board An access request was issued to the host board while the host board is being accessed.	Retry.
101 (65)	Routing parameter error The routing parameter is not set.	Correct the routing parameter.
102 (66)	Data transmission error Data transmission has failed.	Retry. Check if the system is operating normally. Reboot the system.

Return value (HEX)	Error definition	Corrective action
103 (67)	Data receiving error Data receiving has failed.	Retry. Check if the system is operating normally. Reboot the system.
129 (81)	Device type error The specified device type is invalid.	Check the device type.
130 (82)	Device number error The specified device number is out of range. When specifying the bit device, the device number is not a multiple of 8.	Check the device number.
131 (83)	Device points error The specified number of points is out of device range. When specifying the bit device, the device number is not a multiple of 8.	Check the size.
132 (84)	Number of bytes written error The specified number of bytes written is out of range.	Set a number of bytes written that is within the range.
133 (85)	Link parameter error The link parameter is corrupt. The total number of slave station is 0.	Reset the link parameter.
136 (88)	Random write specification error A value other than 0 through 2 was specified for random write.	Set a new value between 0 and 2.
215 (D7)	Reception data length error The length of reception data or byte length is out of range.	Retry. Check the cable.
	Request data buffer length over The length of request data is out of request data area.	Reduce the request data size.
216 (D8)	Protocol error The communication procedure is abnormal. The requested code does not exist.	Check the cable.
217 (D9)	Address error The address is out of access range.	Check the request data.
219 (DB)	Write error Unable to write.	Check the request data.
224 (E0)	PC number error The destination station does not exist.	Correct the station number.
225 (E1)	Processing mode error A processing code that cannot be processed by the destination ACPU was set. (It is checked by the destination ACPU.)	Check the destination ACPU and processing code.
226 (E2)	Special module specification error The specified special module is not a module that can be processed.	Correct the Y number.
227 (E3)	Other data error Incorrect data was found in the address, head step or shift value of the request data.	Correct the request data.
228 (E4)	Link specification error A processing code that cannot be processed by the destination station was set. (It is checked by the destination link module.)	Check the destination station number and processing code.
232 (E8)	Remote error The keyword did not match for the remote RUN/STOP/PAUSE request. Check the destination station number and processing code.	Check the destination station number and processing code.
233 (E9)	Link time over The destination disconnected the link while processing.	Check the hardware of the special module.
234 (EA)	Special module BUSY Either the receive buffer is full at the destination due to transmission of general data, or preparation for receiving data has not been completed.	Check the hardware of the special module.
236 (EC)	Destination BUSY Either the receive buffer is full at the destination due to transmission of general data, or preparation for receiving data has not been completed.	Execute the request when the destination can receive data.
240 (F0)	Link error A request was issued to a disconnected link station.	Return the link.
241 (F1)	Special module bus error Processing preparation has not been completed for the specified special module.	Check the hardware of the special module.

Return value (HEX)	Error definition	Corrective action
242 (F2)	Special module time over No response from the specified special module.	Check the hardware of the special module.
	No response from the MELSENET (II) board.	Check the hardware of the MELSENET (II) board.
1280 (500)	Host board memory access error	Check the switch setting on the host board and move the memory address to the area that is not effected by other board. Change the memory access setting to 16 bit if it is set to 8 bit.
1281 (501)	Unable to access I/O port	Check the I/O port address setting. Perform a board self-loopback test and check the hardware.
16386 (4002)	A request that cannot be processed was received.	Change the request destination.
16432 (4030)	The specified device type does not exist.	Check the specified device type.
16433 (4031)	The specified device number is out of range	Check the specified device number.
16448 (4040)	The module does not exist.	Do not issue a request that generated an error to the specified special module.
16449 (4041)	The number of device points is out of range.	Check the head address and number of access points and access within the existing range.
16450 (4041)	Corresponding module error	Check if the specified module is operating normally
16451 (4043)	The module does not exist at the specified location.	Check the head I/O number of the specified module.
40577 (9E81)	Device type error The device type specified for the destination station is invalid. (It is checked by the destination link module).	Check the device type.
40578 (9E82)	Device number error The device number specified for the destination station is out of range. When specifying the bit device, the device number is not a multiple of 8. (It is checked by the destination link module).	Check the device number.
40579 (9E83)	Devices points error The number of points specified for the destination station is out of range. When specifying the bit device, the device number is not a multiple of 8. (It is checked by the destination link module).	Check the size.
-1 (FFFF)	Path error The specified path is invalid.	Check the bus that was returned by the mdOpen function.
-2 (FFFE)	Device number error The specified device number is out of range. When specifying the bit device, the device number is not a multiple of 8.	Check the head device number for the specified device.
-3 (FFFD)	Device type error The specified device type is invalid.	Check if the device type used is in the device list.
-4 (FFFC)	CPU error An invalid station was specified.	Check the status of the communication station. Check the specified station number.
-5 (FFFB)	Size error The device number and size are over the device range. Access was attempted using an odd device. The device number and size are over the range for the same block.	Check the specified device size. Check the device number and size.
-6 (FFFA)	Number of block error The number of blocks specified in dev[0] for device random read/write is out of range.	Check the number of blocks specified in dev [0].
-8 (FFF8)	Channel number error The channel number specified in the mdOpen function is invalid.	Check the specified channel number.

Return value (HEX)	Error definition	Corrective action
-11 (FFF5)	Insufficient buffer area The read area size of the read data storage array variable is too small.	Check the read size and read data destination size.
-12 (FFF4)	Block error The specified block number of the extension file register is invalid.	Check the block number (device type) of the extension file register.
-13 (FFF3)	Write protect error The specified block number of the extension file register is overlapping with the write protect area of the memory cassette.	Check the block number (device type) of the extension file register. Check the write protect DIP switch of the accessed memory cassette.
-14 (FFF2)	Memory cassette error No memory cassette is loaded to the accessed CPU, or an incorrect memory cassette is loaded.	Check the accessed memory cassette.
-15 (FFF1)	Read area length error The read area size of the read data storage array variable is too small.	Check the read size and read data destination size.
-16 (FFF0)	Station number/network number error The station number/network number is out of range.	Check the specified station number/network number
-17 (FFEF)	All-station/group number specification error A function that does not support all-station specification/group-number specification was specified.	Check if all-station specification/group number specification is enabled for the function.
-18 (FFEE)	Remote instruction error A code that is not designated was specified.	Check the specified code.
-19 (FFED)	SEND/RECV channel number error The channel number specified with the SEND/RECV function is out of range.	Check the specified channel number.
-21 (FFEB)	Error in gethostbyname (•) An error occurred in the function, gethostbyname (•).	Check if the specified host name exists in the HOSTS file.
-24 (FFE8)	Time out error in select (•) A time out error occurred in the function, select (•).	Check if MGW server service has been started on the server machine.
-25 (FFE7)	Error in sendto (•) An error occurred in the function, sendto (•).	Check if normal Ethernet communication can be performed with the server machine.
-26 (FFE6)	Error in recvfrom (•) An error occurred in the function, recvfrom (•).	
-28 (FFE4)	Error response reception An error response was received.	
-29 (FFE3)	Reception data length over Too much data was received.	
-30 (FFE2)	Sequence number error The received sequence number is abnormal.	
-31 (FFE1)	DLL load error An attempt to load a DLL, which is necessary to execute the function, has failed.	Setup the package again.
-32 (FFE0)	Other task/thread is occupying the resource and the resource is not released within 30 seconds.	Retry. There may be a problem of insufficient memory. Terminate other application(s) currently running. Check if the system is operating normally. Reboot the system.
-33 (FFDF)	Incorrect access destination The setting for the communication destination is incorrect.	Check if the communication destination is correctly set by the utility.
-34 (FFDE)	Registry error An attempt to open the registry has failed.	

Return value (HEX)	Error definition	Corrective action
-35 (FFDD)	Registry read error An attempt to read from the registry has failed.	Check if the communication destination is correctly set by the utility.
-36 (FFDC)	Registry write error An attempt to write to the registry has failed.	
-37 (FFDB)	Communication initialization setting error An attempt to perform initial setting for communication has failed.	Retry. There may be a problem of insufficient memory. Terminate other application(s) currently running. Check if the system is operating normally. Reboot the system.
-38 (FFDA)	Ethernet communication error An attempt to set for Ethernet communication has failed.	Retry. Check if the communication destination is correctly set by the utility. There may be a problem of insufficient memory. Terminate other application(s) currently running. Check if the system is operating normally. Reboot the system.
-39 (FFD9)	COM communication setting error An attempt to set for COM communication has failed.	
-41 (FFD7)	COM control error Control cannot be performed properly during COM communication.	Retry. Check if the system is operating normally. Reboot the system.
-42 (FFD6)	Close error Communication cannot be closed.	
-43 (FFD5)	ROM operation error A TC setting value was written to the CPU during ROM operation.	Change the TC setting value during RAM operation.
-44 (FFD4)	LLT communication setting error An attempt to set for LLT communication has failed.	Retry. Check if the communication destination is correctly set by the utility. There may be a problem of insufficient memory. Terminate other application(s) currently running.
-45 (FFD3)	Ethernet control error Control cannot be performed properly during Ethernet communication.	
-46 (FFD2)	USB open error Failed to initialize and open the USB port.	There may be a problem of insufficient memory. Terminate other application (s) currently running. Check if the system is operating normally. Reboot the system.
-47 (FFD1)	Random read condition disable error The random read condition is not enabled and random read cannot be performed.	A conditional random read has been set via a switch such as GPPW. Wait until the condition is enabled. Alternatively, cancel the condition.
-50 (FFCE)	Opened path maximum value over The number of open paths exceeds the maximum value (32).	Close several paths.
-51 (FFCD)	Exclusive control error An error occurred in the exclusive control.	Retry. Check if the system is operating normally.
-2174 (F782)	Destination station number specification error The destination station number for the processing request is specifying the host.	Check the destination station number.
-16386 to -20222 (B102 to BFFE)	See AJ61QBT11/A1SJ61QBT11 CC-Link system master local module user's manual.	Same as left.
-18560 (B780)	Transient was issued to the remove I/O.	Check the destination station to request.
-18575 (B771)	A device for other station only was accessed to the host.	Check the device type.
-24957 (9E83)	Device points error The number of points specified for the destination station is out of device range. When specifying the bit device, the device number is not a multiple of 8. (It is checked by the destination link module.)	Check the size.
-24958 (9E82)	Device number error The device number specified for the destination station is out of range. When specifying the bit device, the device number is not a multiple of 8. (It is checked by the destination link module.)	Check the device number.
-24959 (9E81)	Device type error The device type specified for the destination station is invalid. (It is checked by the destination link module.)	Check the device type.

Return value (HEX)	Error definition	Corrective action
-25056 (9E29)	Processing code error A processing code that cannot be processed by the destination station was set. (It is checked by the destination link module.)	Check the destination station number and processing code.
-26333 (9923)	The ROM version of the I/F board does not match the QCPU (Q mode).	Access a CPU other than the QCPU (Q mode). Use the I/F board supplied with the module (ROM version: "W" or later) after the SW3DNF-CCLINK.
-26334 (9922)	Board reset error Other process has executed a board reset using the same channel while other station is being accessed.	Retry.
-26336 (9920)	Request error for other loop Routing to other loop was performed.	Change the routing destination to AnUCPU or QnACPU.
-28150 (920A)	Data link disconnecting error	A host link device was accessed while the data link is being disconnected.
-28151 (9209)	APS No. error. An incorrect response data was received.	Change the equipment at the process request destination.
-28156 (9204)	Dual-port hand-shake error	Remove other optional board.
-28158 (9202)	WDT error	Reset the board. Reboot the PC.

11 . TROUBLESHOOTING

This chapter describes how to determine the cause of trouble that may occur during system construction as well as appropriate corrective actions.

11.1 When Performing Troubleshooting

Ideally occurrence of trouble should be kept to a minimum in order to startup the system effectively. However, once an error occurs, it is important that we identify the cause as quickly as possible. The followings are the three basic points that must be kept in mind when performing troubleshooting.

(1) Visual check

Check the following points.

- 1) Movement of the external device (status when stopped or during operation)
- 2) On/off status of power supply
- 3) Wiring condition (cable)
- 4) LED display status (power supply display LED)
- 5) Checks whether the PC is one suitable for the operating environment

After checking 1) through 5), connect the external device and check the operation of the user program.

(2) Confirming the error

Examine how the error status changes by the following operation.

- 1) Change the input status and check if the change can be read correctly using the test program.
- 2) Repeat on/off of output and check if the status of the external device changes accordingly.

(3) Narrowing the range

Based on the steps 1) and 2) above, deduce the range of error location as one of the following.

- 1) PC side or external device side
- 2) PC main body or board
- 3) Cable
- 4) User program

11.2 Troubleshooting Table by the Type of Error Occurring

When trouble occurs, refer to the methods in Table 11.1 for determining the cause of the trouble.

Table 11.1 Troubleshooting table by the type of error occurring

No.	[Error content]	[Cause determination method]
1	An I/F board did not operate normally upon startup.	See the flowchart found in Section 11.3 for when the board and PC do not operate.
2	There was no data linking although the master station and other station were connected to the I/F board.	See the flowchart found in Section 11.4 for when the data link could be completed.
3	When an error occurs during the data link 1) An unexpected value is entered in the special device. 2) The device is being accessed using a function in the user program, but data cannot be read or written. 3) Communication stops occasionally while the user program is executing. 4) The system goes down (blue screen) or resets while the user program is executing in Windows NT 4.0 or Windows 95/98.	See the flowchart found in Section 11.5 for when an error occurs during data linking.

11.3 Flowchart to Use when the Board or PC do not Operate

The following indicates a check procedure in the PC unit when the I/F board does not run normally during startup.

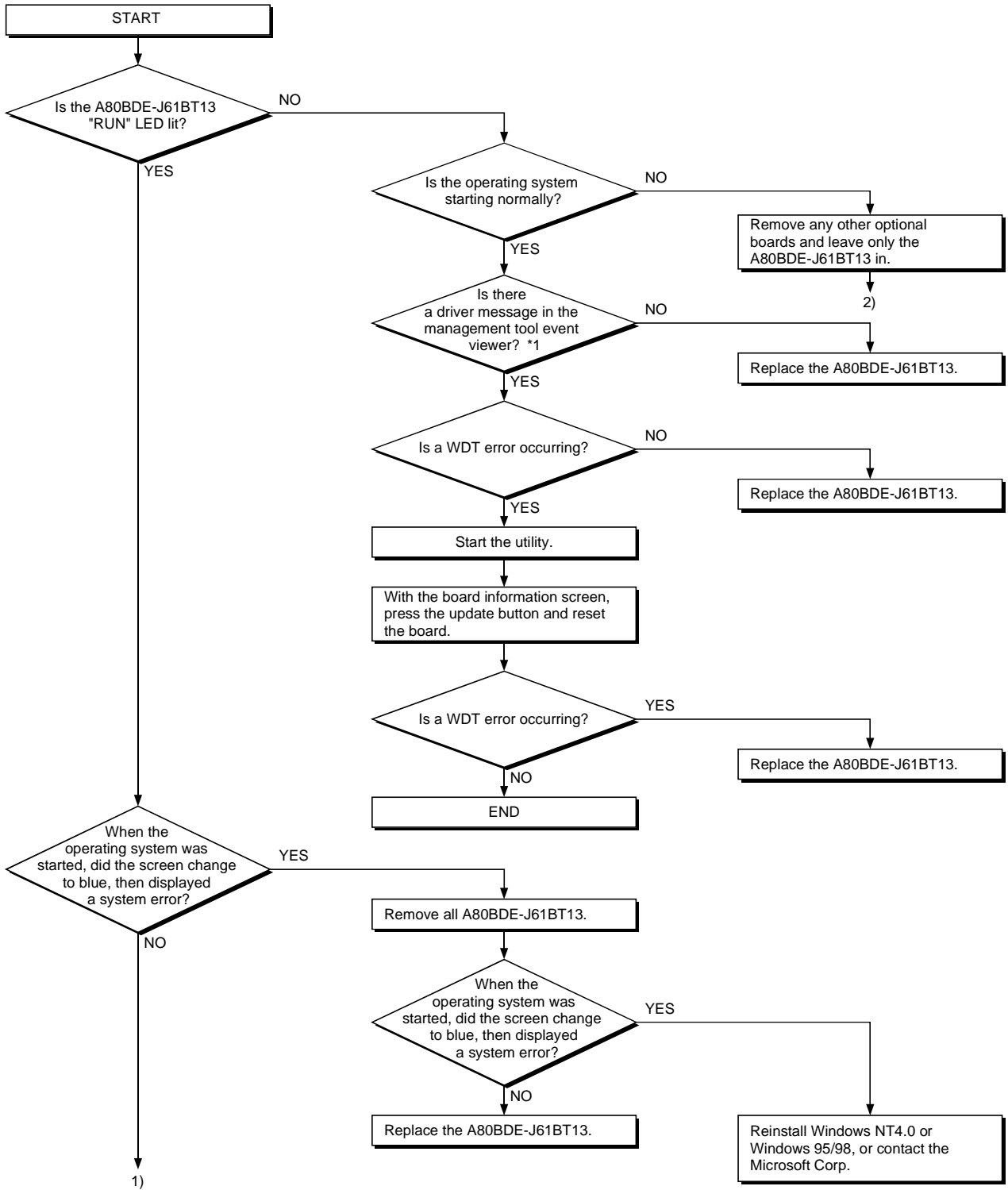

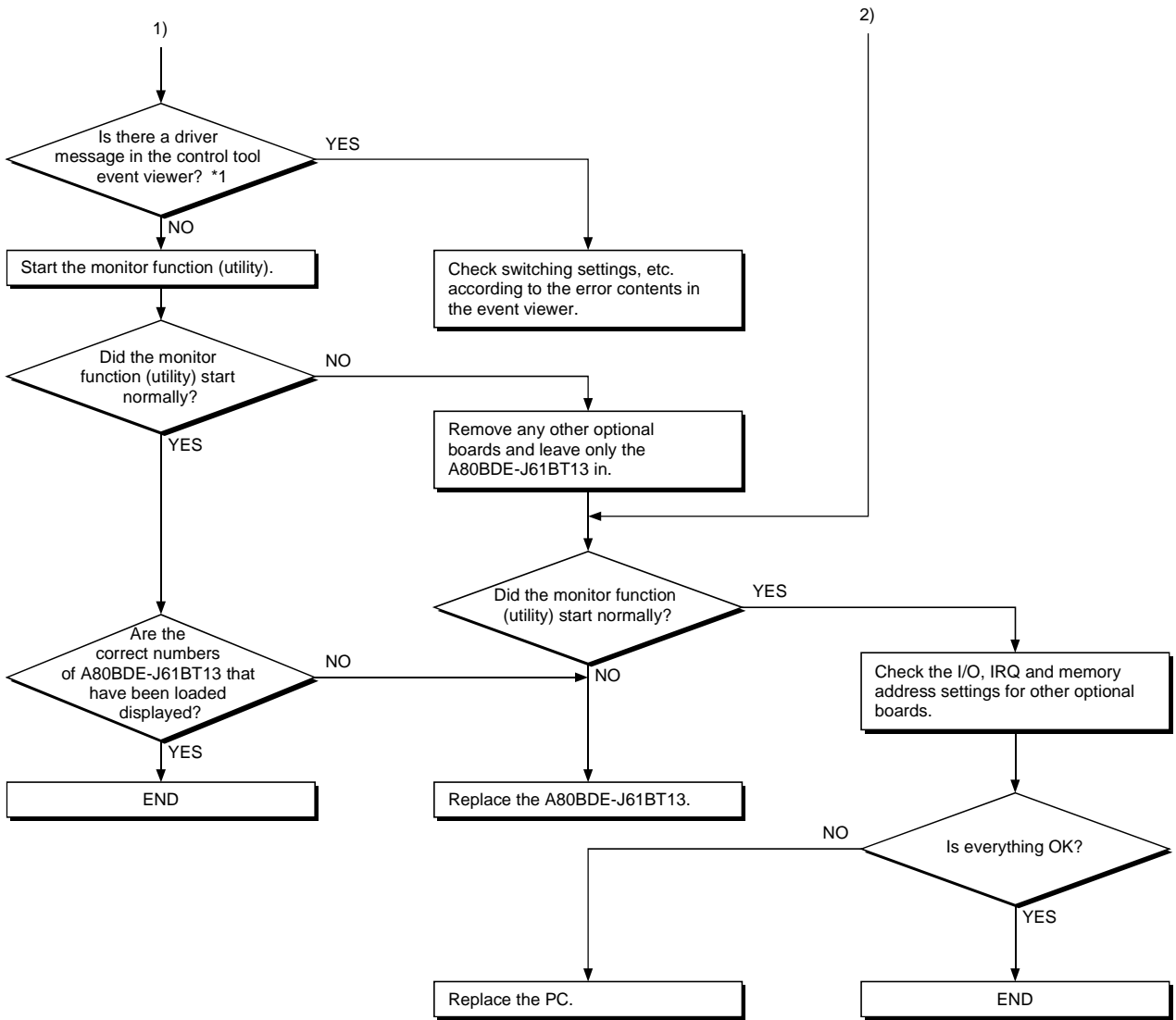

*1 : With Windows 95 or 98, check the driver message in the error viewer.

11.3.1 Table of error event messages that may occur during driver startup

The table below lists the errors displayed in the event viewer/error viewer.

Event ID (HEX)	Error content	Corrective action
256 (100)	The driver could not be executed because an error occurred during driver startup.	Reinstall the driver package. If the error occurs again, reinstall Windows NT 4.0 or Windows 95/98.
257 (101)	The I/F board could not be detected.	Check the installation status of the I/F board.
258 (102)	No response from hardware.	Replace the I/F board.
259 (103)	The number of boards detected exceeds the maximum number that can be loaded.	Remove boards until the number falls within the maximum limit.
262 (106)	An attempt to link the device name has failed.	Reinstall Windows NT 4.0 or Windows 95/98.
268 (10C)	An error occurred during receiving process. (The request packet is incorrect).	Check the PC and PLC program for which the processing is being requested to this PC.
269 (10D)	An error occurred during transmission process.	
279 (117)	An error occurred when writing to the registry.	Reinstall the software package.
280 (118)	A request that cannot be processed was received from other station. (A request for which a response request cannot be processed was received)	Check the PC and PLC program for which the processing is being requested to this PC.
282 (11A)	Mapping of the I/O port has failed.	The I/O port is overlapping with another resource. Remove other optional boards.
283 (11B)	The shared memory area of the I/F board is overlapping with other hardware.	Remove other optional boards.
284 (11C)	The I/F board IRQ is overlapping with other hardware.	Remove other optional boards.
285 (11D)	It is possible the I/F board will not operate normally, since it detected a temperature abnormality.	Install the PC in a location with a suitable temperature.
286 (11E)	Failed to secure the memory area required to start the driver.	Increase system memory.
288 (120)	A WDT error occurred.	Remove other optional boards.
289 (121)	Handshaking with the shared memory area has failed.	Reset the board. If the error occurs again, replace the board.
290 (122)	The board number of the I/F board is a duplicate.	Reset so there are no duplicate board numbers.
291 (123)	Failed in mapping the shared memory area.	Remove other optional boards.
293 (125)	Interrupt registration has failed.	Remove other optional boards.
294 (126)	The I/O port for the I/F board is overlapping with other hardware.	Remove other optional boards. *1

Event ID (HEX)	Error content		Corrective action	
1281 (501)		DUMP value	Error contents (details)	_____
	Initiali- zation of the I/F board has failed.	01h	There is no response from the hardware.	Replace the I/F board.
		02h	The IRQ or memory is overlapping. *2	Remove other optional boards.
		03h	There is no response from the hardware.	Replace the I/F board.
		04h	Handshaking with the shared memory area has failed.	Restart. If the error occurs again, replace the board.
		66h	There is no response from the hardware.	Replace the I/F board.

DUMP value..... Value of the 1 byte at the head of the data contents details area

*1 : If this event error occurs in the Windows NT 4.0 event viewer, restart the PC that has the BIOS setup shown below after setting the "Plug & Play O/S" in [No] and "Reset Configuration Data" in [Yes] as in the following example.

Example)
BIOS Setup Utility

Set Plug & Play O/S : [YES] → [No]
Reset Configuration Data: [No] → [YES]

Then restart.

*2 : This event error may occur when the PCI bus controller is not operating correctly.
When the PC being used comes pre-installed with Windows 95/98, use the drivers for Windows 95/98 and the PCI bus controller that come in the PC unit.
If Windows 95/98 have been purchased separately, obtain the drivers for the PCI bus controller suggested by the PC manufacturer and install.

11.4 Flowchart to Use when the Data Link could not be Completed

The following flowchart indicates when the data link could not be completed even though the I/F board was connected to another station.

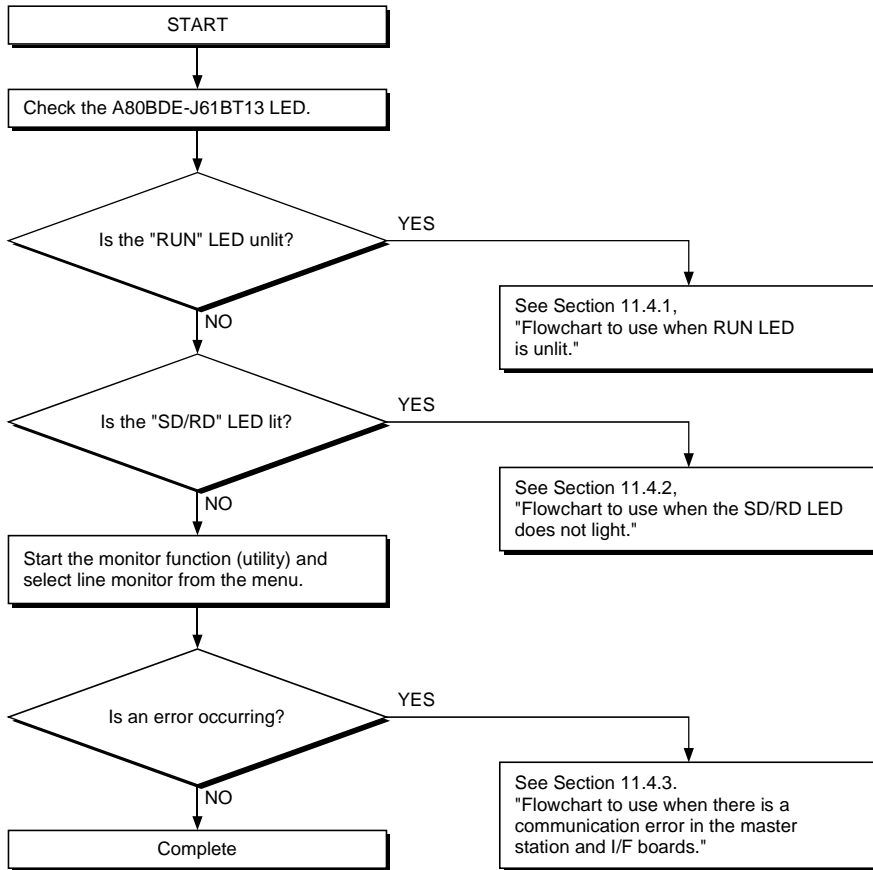

11.4.1 Flowchart to use when RUN LED is unlit

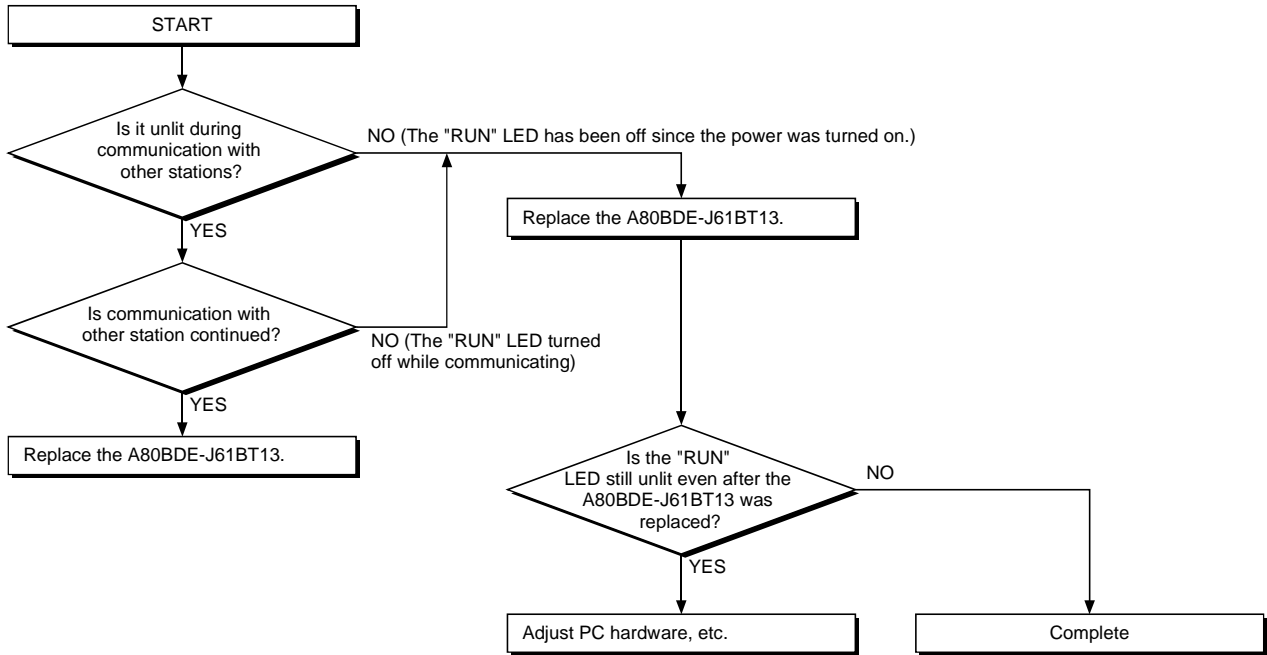

11.4.2 Flowchart to use when SD/RD LED does not turn on

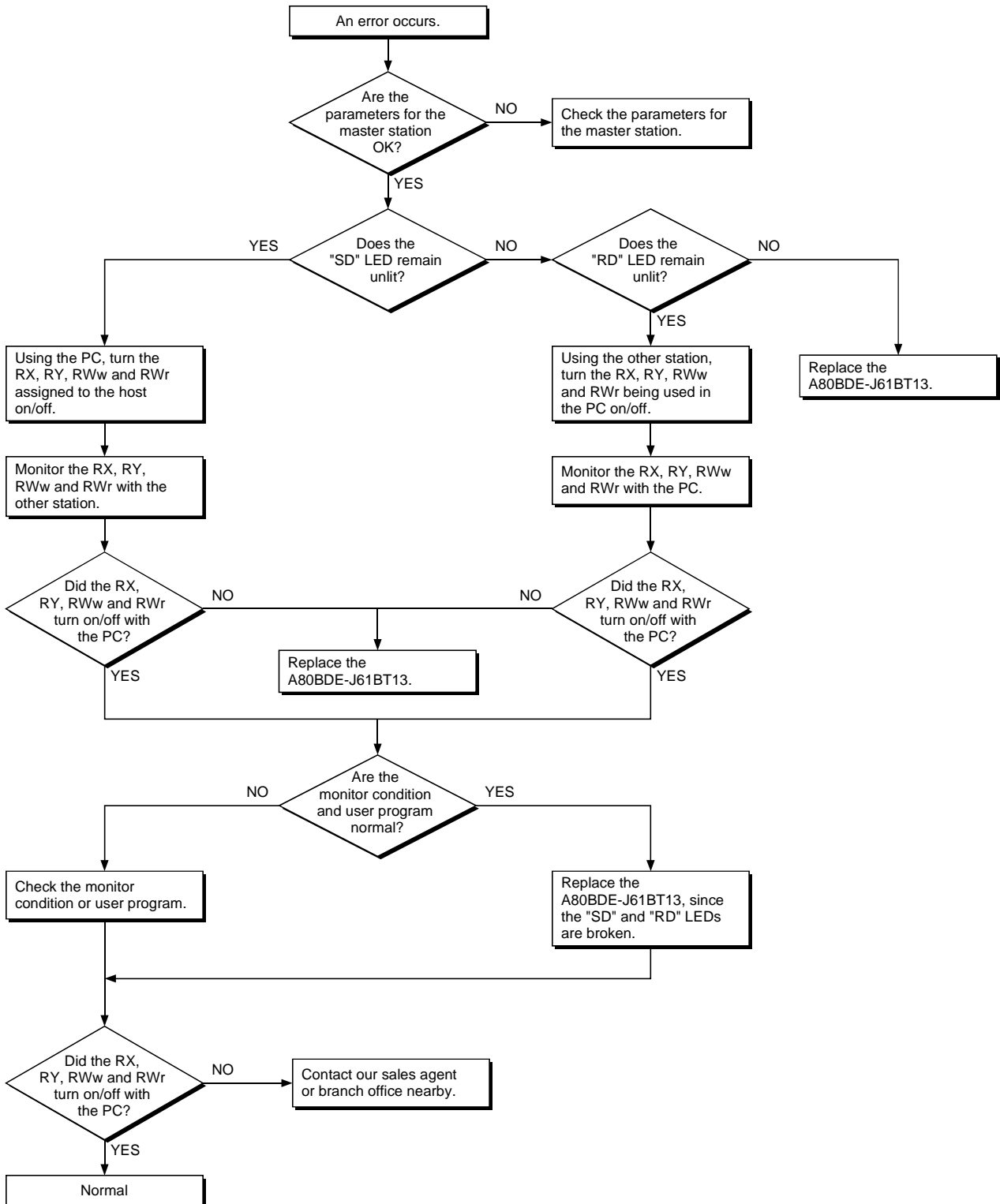

11.4.3 Flowchart to use when there is a communication error between the master station and I/F board

When a station number duplicate bit turns on in the link special register SW0098 to SW009B (station number duplicate status), check the I/F board of the relevant station number using the following procedure.

Troubleshooting flowchart when the "ERR." LED for the master station is flashing



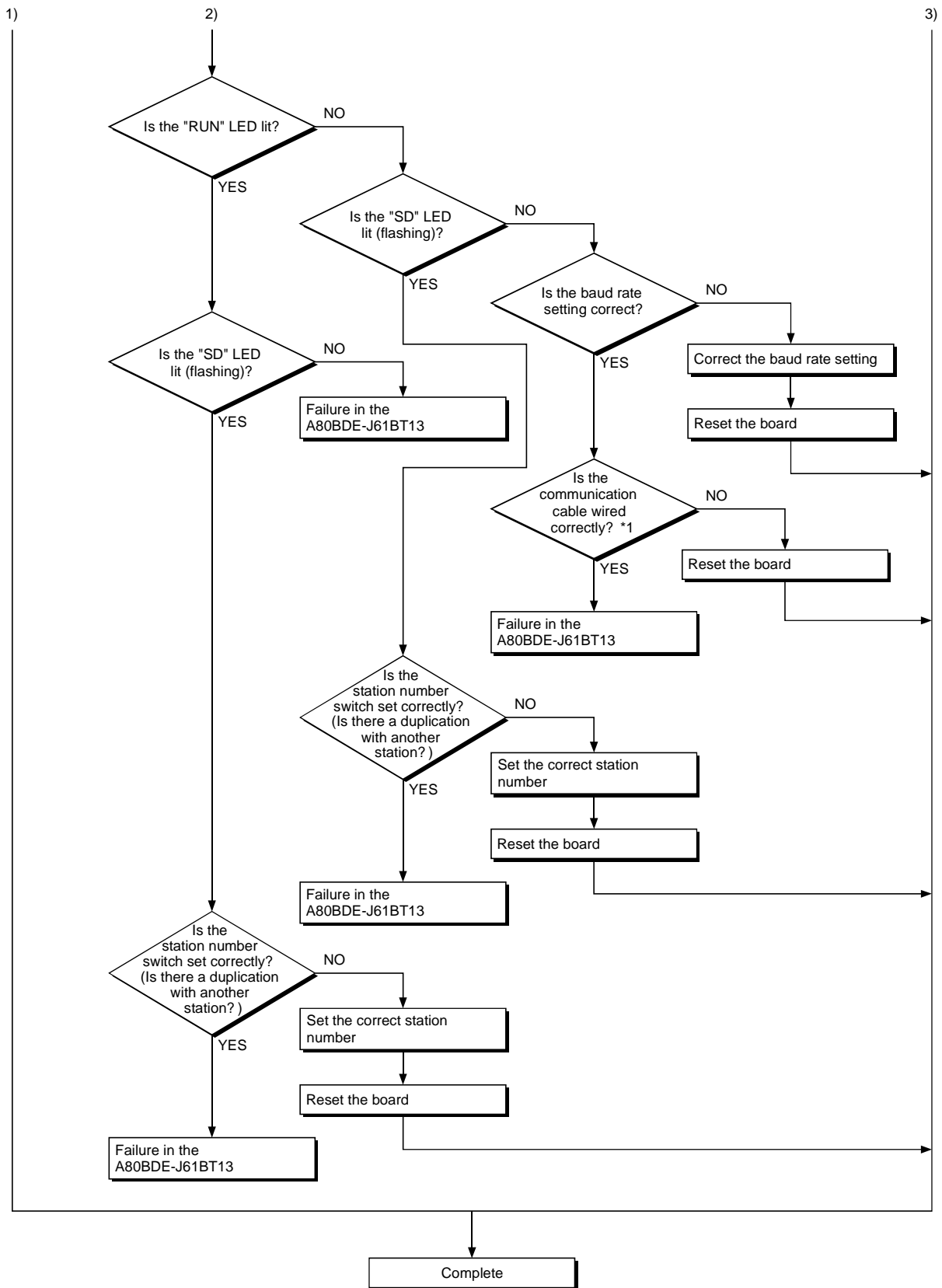

*1 : Check for shorts, reversed connection, broken connection, terminal resistor, FG connection, total extended distance, and distance between stations

11.5 Flowchart to Use when an Error Occurs During Data Linking

The following flowchart indicates when an error occurs during data linking is shown.

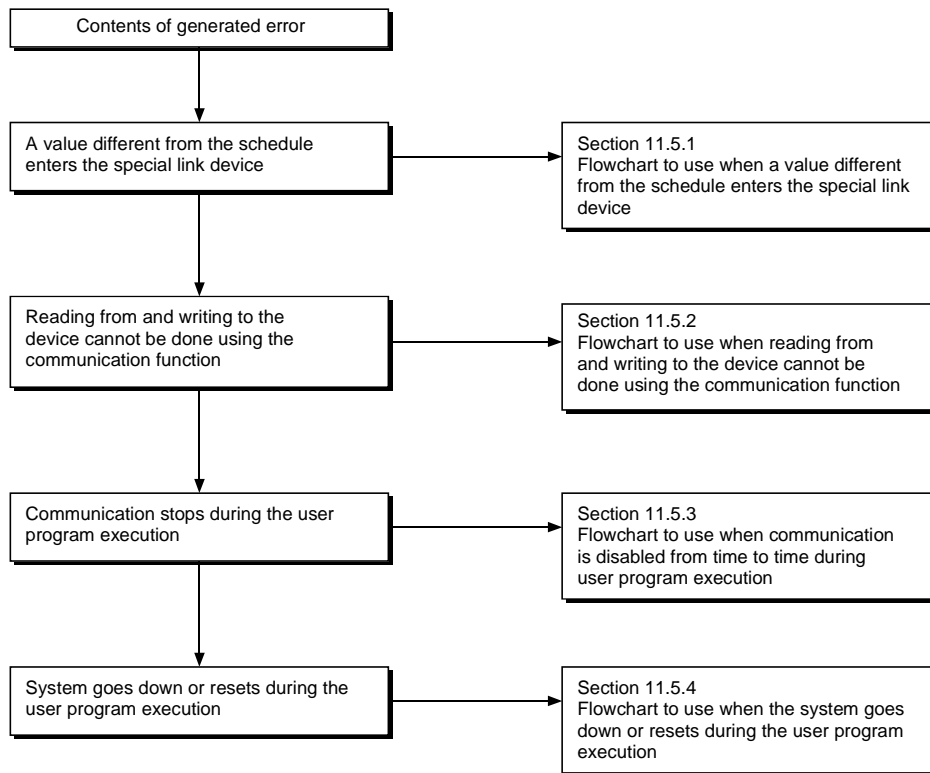

11.5.1 Flowchart to use when unexpected value is input to specific link device

Check the following items.

- 1) Check for a station with link error using the network monitor in the monitoring function.
- 2) Check the link parameter assignment range at the master station.
- 3) Check the device range used in the PLC program at the PLC.
- 4) Check, in the user program, argument data for the communication function accessing the specific link device.

11.5.2 Flowchart to use when reading from and writing to the device cannot be done using the communication function

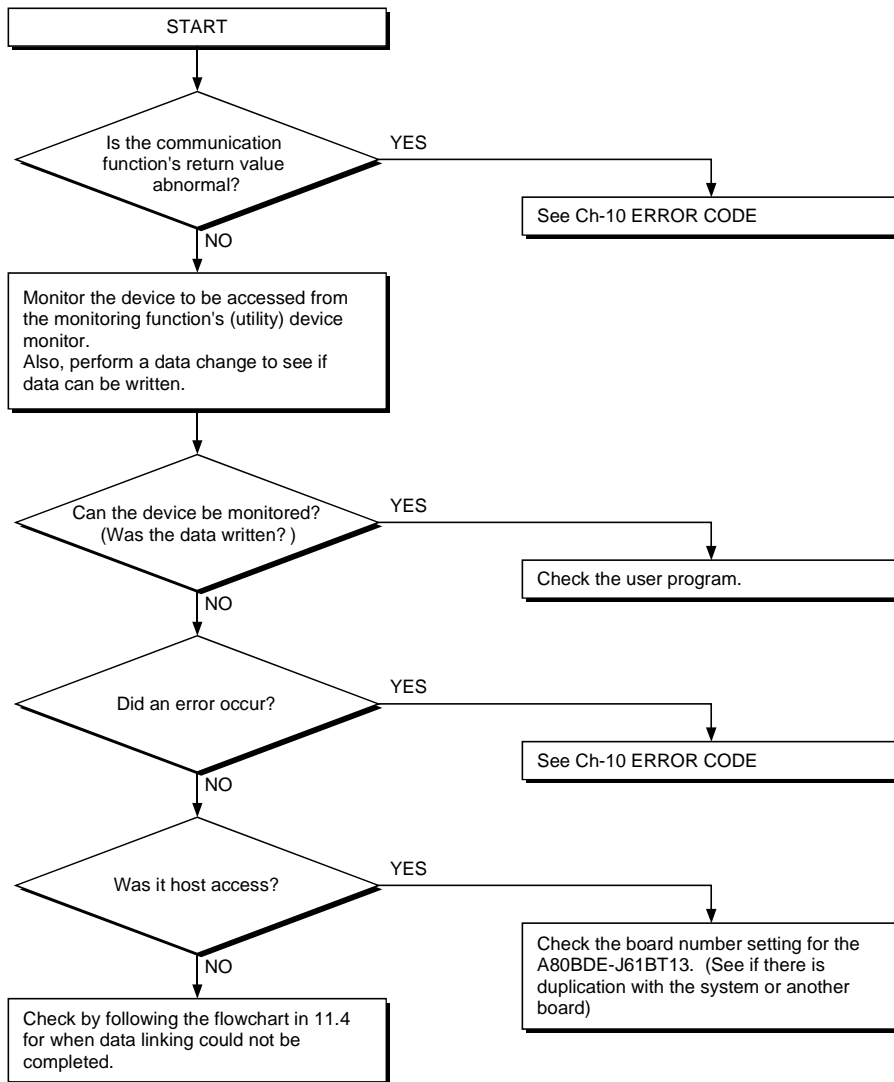

11.5.3 Flowchart to use when communication is disabled from time to time during user program execution

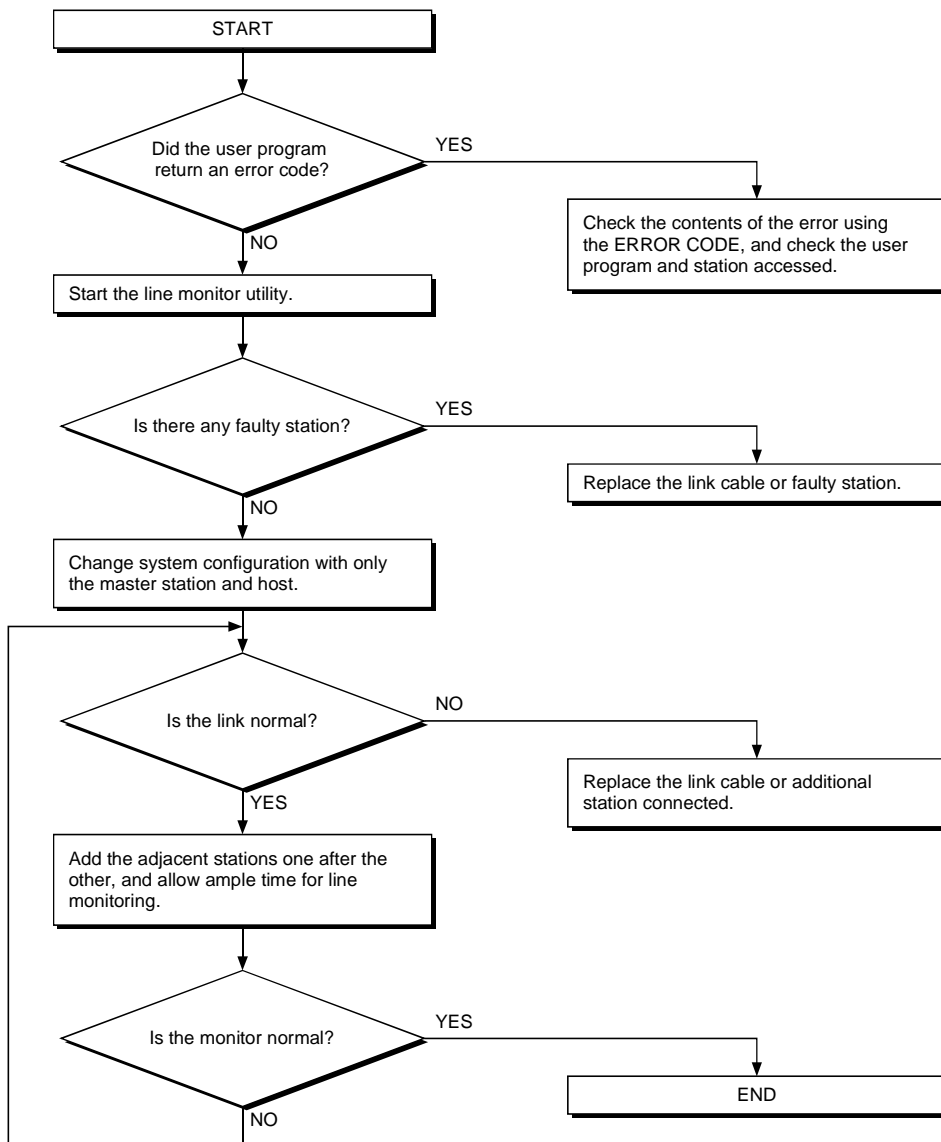

11.5.4 Flowchart to use when the system goes down or resets during the user program execution

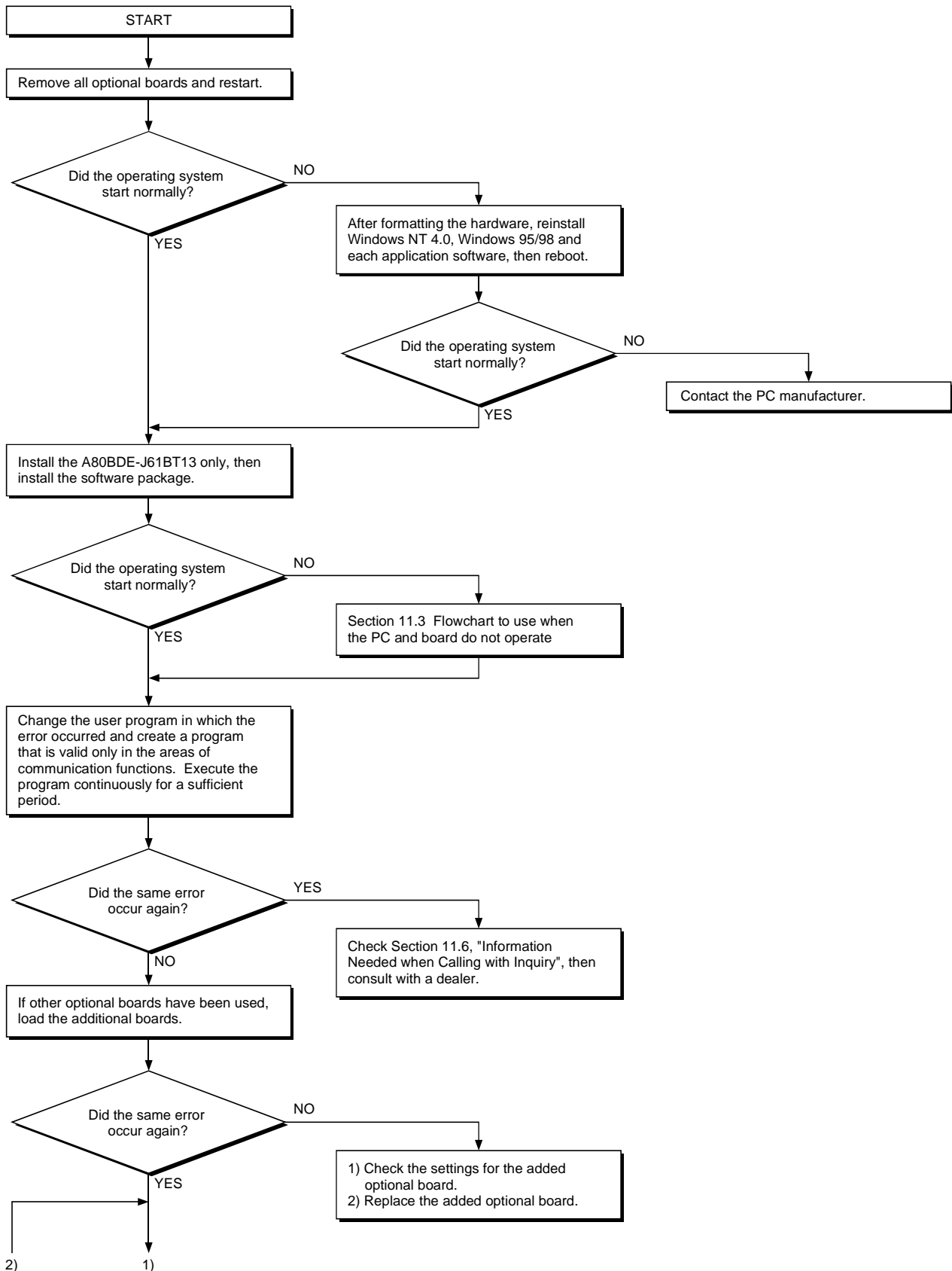

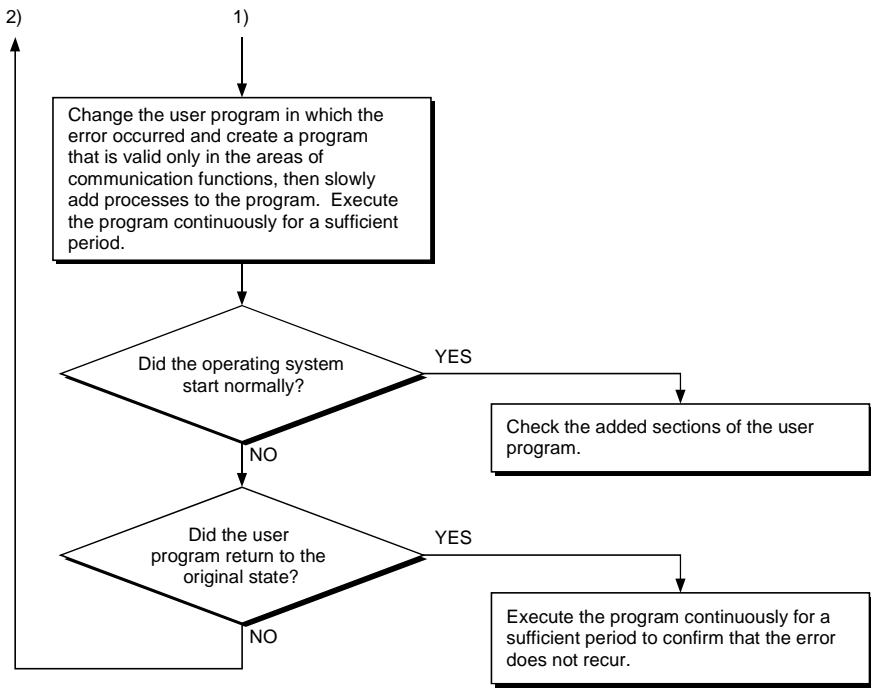

11.6 Information Needed when Calling with Inquiry

The following conditions and status must be reported when calling us with an inquiry regarding a damaged board.

(1) Error state (be specific)

Example) The system does not start during the startup process after turning on the power, displaying a "board Not response" message.

(2) PC manufacturer, PC name/model

(3) Main memory capacity, hard disk capacity, CPU model

(4) OS name : Windows NT Workstation 4.0, Windows 95/98

(5) Position of installation slot, number of boards installed

(6) Use of optional boards made by other companies.

(7) When optional boards made by other companies are installed, have the following items for each board available.

- Board model
- Board manufacturer
- Memory address (head address and occupied size)
- I/O address (head address and occupied size)
- IRQ number, DMA number

(8) Whether a comparison check in another PC has been done

(9) Switch setting

(10) Details of the CC-Link driver error registered in the event viewer (for Windows NT 4.0) or the error viewer (Windows 95/98)

APPENDIX

Appendix 1 External Dimensions

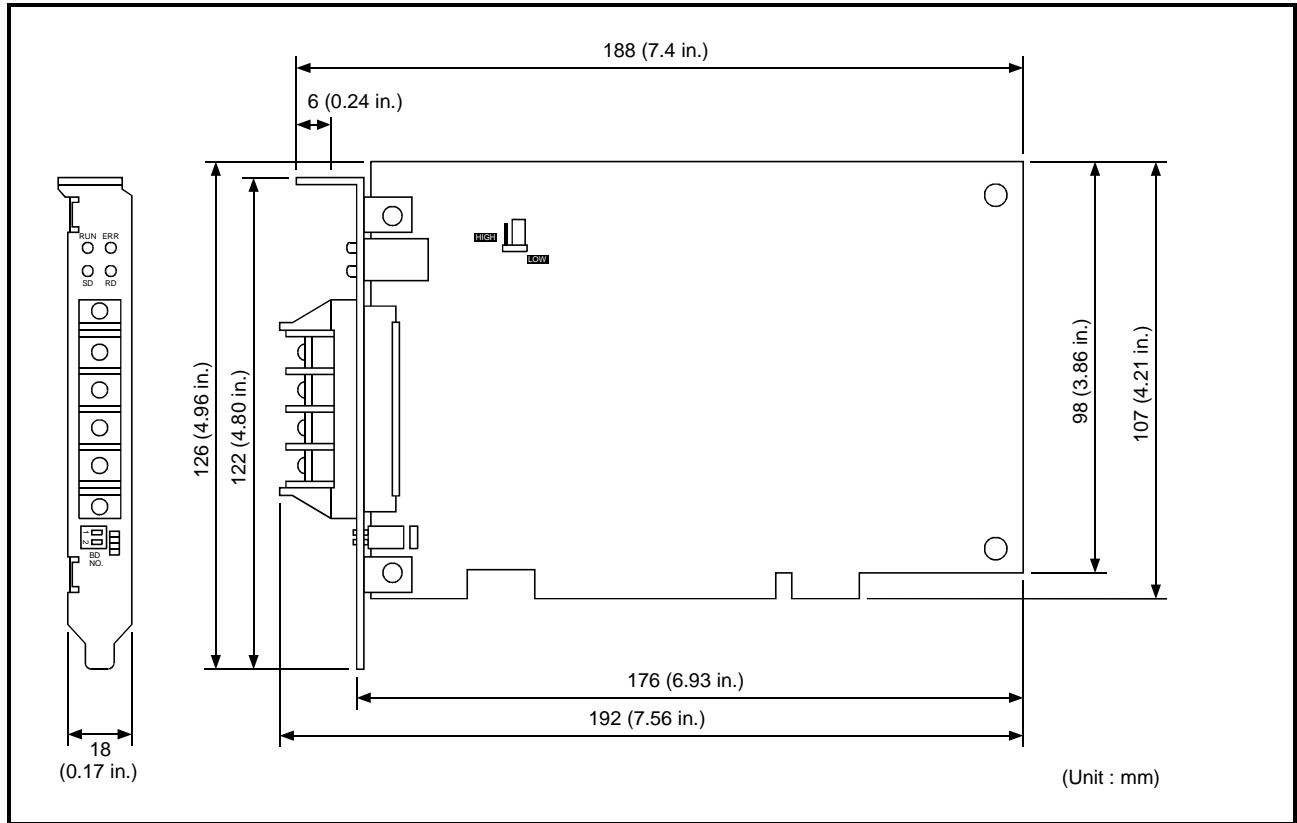

Appendix 2 Measures Regarding Year 2000 Problem

Our software packages are all Y2K ready, being capable of recognizing years prior to 1999 and after 2000 as well as making leap-year date corrections.

The table below shows the Y2K compliance status of our products.

Software Package	OS					
	Windows 95		Windows 98		Windows NT 4.0	
	A	B	A	B	A	B
SW3DNF-CCLINK	○ *1	○	○ *1	○	○	○

A: Normal year transition B: Automatic date correction for leap year
 ○: Y2K-ready x: Countermeasure necessary

*1 : [When personal computer is year 2000 compatible model]
 Measures are not required.

[When personal computer is not year 2000 compatible model]

If continuous operation is being carried out when shifting from the year 1999 to year 2000, the date will be updated and the leap year will be compensated normally.

However, if the system is reset or the power is turned ON again after the year 2000, the date may be illegal depending on the model.

If a log is recorded in the error viewer when the above date data is incorrect (i.e., when a driver error occurs), the log will be recorded with the incorrect date.

<Measures>

When starting up the system for the first time after the year 2000, reset the date with the BIOS setting utility or with "Date/Time" in the Windows 95 or Windows 98 control panel.

WARRANTY

Please confirm the following product warranty details before starting use.

1. Gratis Warranty Term and Gratis Warranty Range

If any faults or defects (hereinafter "trouble") found to be the responsibility of Mitsubishi occurs during use of the product within the gratis warranty term, the product shall be repaired at no cost via the dealer or Mitsubishi Service Company.

Note that if repairs are required at a site overseas, on a detached island or remote place, expenses to dispatch an engineer shall be charged for.

[Gratis Warranty Term]

The gratis warranty term of the product shall be for one year after the date of purchase or delivery to a designated place.

Note that after manufacture and shipment from Mitsubishi, the maximum distribution period shall be six (6) months, and the longest gratis warranty term after manufacturing shall be eighteen (18) months. The gratis warranty term of repair parts shall not exceed the gratis warranty term before repairs.

[Gratis Warranty Range]

- (1) The range shall be limited to normal use within the usage state, usage methods and usage environment, etc., which follow the conditions and precautions, etc., given in the instruction manual, user's manual and caution labels on the product.
- (2) Even within the gratis warranty term, repairs shall be charged for in the following cases.
 1. Trouble occurring from inappropriate storage or handling, carelessness or negligence by the user. Trouble caused by the user's hardware or software design.
 2. Trouble caused by unapproved modifications, etc., to the product by the user.
 3. When the Mitsubishi product is assembled into a user's device, trouble that could have been avoided if functions or structures, judged as necessary in the legal safety measures the user's device is subject to or as necessary by industry standards, had been provided.
 4. Trouble that could have been avoided if consumable parts (battery, backlight, fuse, etc.) designated in the instruction manual had been correctly serviced or replaced.
 5. Trouble caused by external irresistible forces such as fires or abnormal voltages, and trouble caused by force majeure such as earthquakes, lightning, wind and water damage.
 6. Trouble caused by reason unpredictable by scientific technology standards at time of shipment from Mitsubishi.
 7. Any other trouble found not to be the responsibility of Mitsubishi or the user.

2. Onerous repair term after discontinuation of production

- (1) Mitsubishi shall accept onerous product repairs for seven (7) years after production of the product is discontinued. Discontinuation of production shall be notified with Mitsubishi Technical Bulletins, etc.
- (2) Product supply (including repair parts) is not possible after production is discontinued.

3. Overseas service

Overseas, repairs shall be accepted by Mitsubishi's local overseas FA Center. Note that the repair conditions at each FA Center may differ.

4. Exclusion of chance loss and secondary loss from warranty liability

Regardless of the gratis warranty term, Mitsubishi shall not be liable for compensation to damages caused by any cause found not to be the responsibility of Mitsubishi, chance losses, lost profits incurred to the user by troubles in Mitsubishi products, damages and secondary damages caused from special reasons regardless of Mitsubishi's expectations, compensation for accidents, and compensation for damages to products other than Mitsubishi products and other duties.

5. Changes in product specifications

The specifications given in the catalogs, manuals or technical documents are subject to change without prior notice.

6. Product application

- (1) In using the Mitsubishi MELSEC programmable logic controller, the usage conditions shall be that the application will not lead to a major accident even if any trouble or fault should occur in the programmable logic controller device, and that backup and fail-safe functions are systematically provided outside of the device for any trouble or fault.
- (2) The Mitsubishi general-purpose programmable logic controller has been designed and manufactured for applications in general industries, etc. Thus, applications in which the public could be affected such as in nuclear power plants and other power plants operated by respective power companies, and applications in which a special quality assurance system is required, such as for each Japan Railways company or the Department of Defense shall be excluded from the programmable logic controller applications.

Note that even with these applications, if the user approves that the application is to be limited and a special quality is not required, application shall be possible.

When considering use in aircraft, medical applications, railways, incineration and fuel devices, manned transport devices, pleasure equipment and safety devices, in which human life or assets could be greatly affected and for which a particularly high reliability is required in terms of safety and control system, please consult with Mitsubishi and discuss the required specifications.

Type A80BDE-J61BT13 CC-Link Interface Board

User's Manual (For SW3DNF-CCLINK)

MODEL	A80BD-BT13-SW3-U-E
MODEL CODE	13JL94
IB(NA)0800036-A(9909)MEE	



HEAD OFFICE : MITSUBISHI DENKI BLDG MARUNOUCHI TOKYO 100-8310 TELEX : J24532 CABLE MELCO TOKYO
NAGOYA WORKS : 1-14 , YADA-MINAMI 5 , HIGASHI-KU, NAGOYA , JAPAN

When exported from Japan, this manual does not require application to the Ministry of International Trade and Industry for service transaction permission.

Specifications subject to change without notice.