

MITSUBISHI

D/A Converter Module Type A62DA

User's Manual

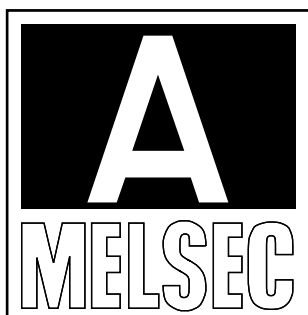
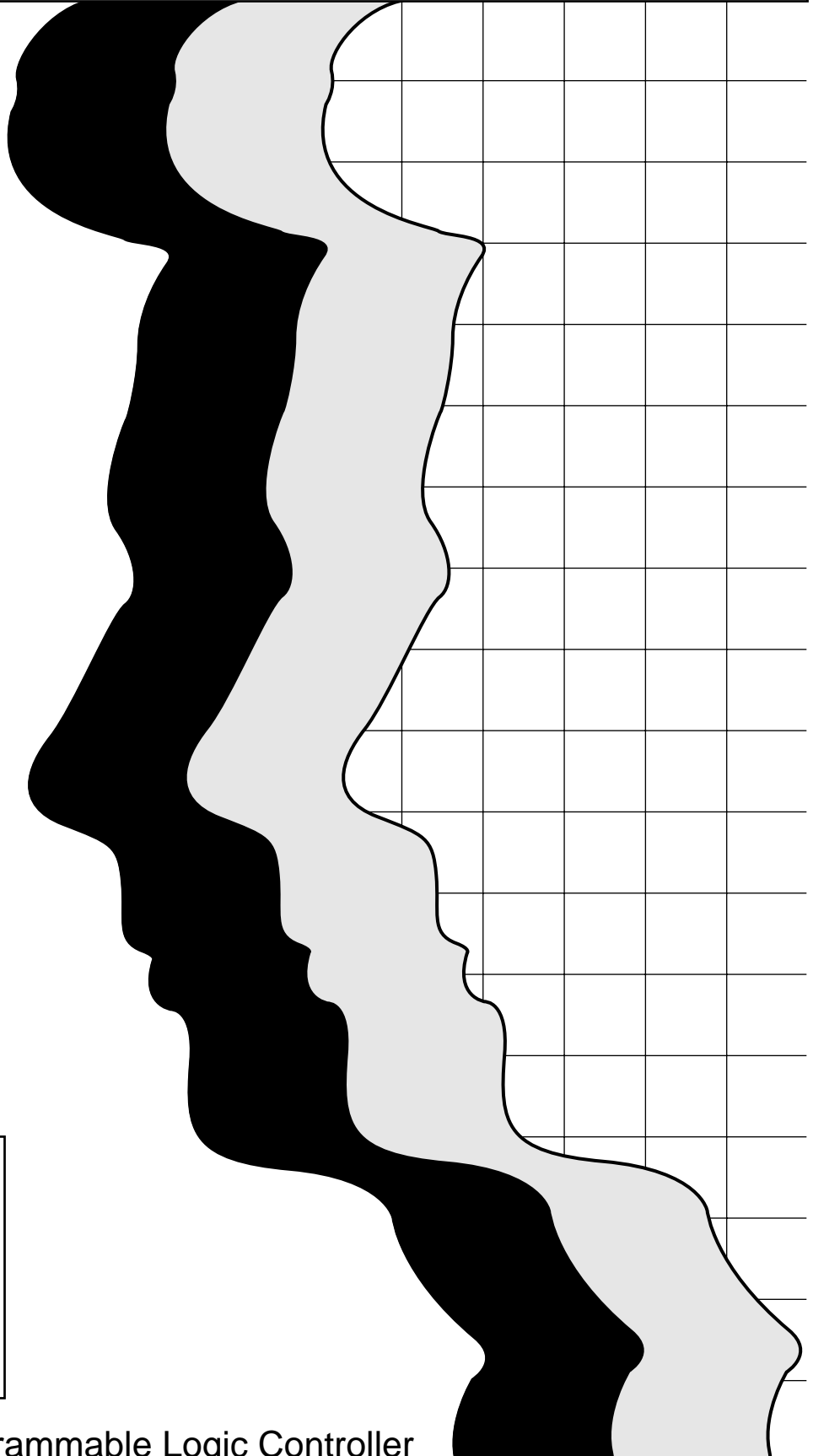

Mitsubishi Programmable Logic Controller

● SAFETY PRECAUTIONS ●

(Always read these instructions before using this equipment.)

Before using this product, please read this manual and the relevant manuals introduced in this manual carefully and pay full attention to safety to handle the product correctly.

The instructions given in this manual are concerned with this product. For the safety instructions of the PLC system, please read the user's manual of the CPU module to use.

In this manual, the safety instructions are ranked as "DANGER" and "CAUTION".



DANGER

Indicates that incorrect handling may cause hazardous conditions, resulting in death or severe injury.



CAUTION

Indicates that incorrect handling may cause hazardous conditions, resulting in medium or slight personal injury or physical damage.

Note that the  **CAUTION** level may lead to a serious consequence according to the circumstances. Always follow the instructions of both levels because they are important to personal safety.

Please save this manual to make it accessible when required and always forward it to the end user.

[DESIGN PRECAUTIONS]

DANGER

- Install a safety circuit external to the PLC that keeps the entire system safe even when there are problems with the external power supply or the PLC module.
Otherwise, trouble could result from erroneous output or erroneous operation.
 - (1) The analog output state will differ according to the setting state of the various functions for controlling the analog output.
Take special care when making the settings.
Refer to section 3.3.2 for details on the analog output state.
 - (2) If there is a fault in the output element or the internal circuit, correct outputs may not be possible or erroneous outputs may be made.
Provide a circuit to externally monitor output signals that could lead to major faults.

CAUTION

- Do not bunch the control wires or communication cables with the main circuit or power wires, or install them close to each other.
They should be installed 100mm (3.94inch) or more from each other.
Not doing so could result in noise that would cause erroneous operation.
- At power ON/OFF, voltage or current may instantaneously be output from the output terminal of this module.
In such case, wait until the analog output becomes stable to start controlling the external device.

[INSTALLATION PRECAUTIONS]

CAUTION

- Use the PLC in an environment that meets the general specifications given in the User's Manual of the CPU module in use.
Using this PLC in an environment outside the range of the general specifications could result in electric shock, fire, erroneous operation, and damage to or deterioration of the product.
- Securely insert the module fixing latch on the module bottom into the fixing holes on the base unit before mounting. Incorrect mounting of the module could lead to erroneous operation, faults or drop.
For use in the environment of frequent vibration, tighten the module with screws.
- Do not directly touch the module's conductive parts or electronic components.
Touching the conductive parts could cause an operation failure or give damage to the module.
- Tighten the terminal screws with the specified torque.
If the terminal screws are loose, it could result in short circuits, fire or erroneous operation.
Overtightening can cause a drop, short circuits or malfunction due to damage to the screw or module.

[WIRING PRECAUTIONS]

CAUTION

- When wiring in the PLC, be sure that it is done correctly by checking the product's rated voltage and the terminal layout.
Connecting a power supply that is different from the rating or incorrectly wiring the product could result in fire or damage.
- Tighten the terminal screws with the specified torque.
If the terminal screws are loose, it could result in short circuits, fire, or erroneous operation.
Overtightening can cause a drop, short circuits or malfunction due to damage to the screw or module.
- Be sure there are no foreign substances such as sawdust or wiring debris inside the module.
Such debris could cause fires, damage, or erroneous operation.

[STARTUP AND MAINTENANCE PRECAUTIONS]

CAUTION

- Do not touching the terminals with power on.
Failure to observe this could lead to erroneous operation.
- Be sure to shut off all phases of the external power supply before cleaning or retightening the terminal screws.
Not doing so can cause a module failure or malfunction.
If the terminal screws are loose, it could result in short circuits, fire or erroneous operation.
Overtightening can cause a drop, short circuits or malfunction due to damage to the screw or module.
- Do not disassemble or modify the module.
Doing so could cause trouble, erroneous operation, injury, or fire.

[STARTUP AND MAINTENANCE PRECAUTIONS]

 **CAUTION**

- Be sure to shut off all phases of the external power supply used by the system before mounting or removing the module.
If you do not switch off the external power supply, it will cause failure or malfunction of the module.
- Before handling the module, always touch grounded metal, etc. to discharge static electricity from the human body.
Failure to do so can cause the module to fail or malfunction.

[DISPOSAL PRECAUTIONS]

 **CAUTION**

- When disposing of the product, handle it as industrial waste.

REVISIONS

※The manual number is given on the bottom left of the back cover.

Print Date	*Manual Number	Revision
Nov., 1986	IB (NA) 66053-A	First edition
Jan., 1989	IB (NA) 66053-B	<div style="border: 1px solid black; padding: 2px; width: fit-content; margin-bottom: 5px;">Correction</div> CONTENTS, Page 1-1, 2-2, 2-3, 3-1, 3-2, 3-4, 3-6, 3-8, 4-1, 4-2, 6-2, 6-4, 7-1, 8-1, 8-2, 8-3, 8-4, APP-1 <div style="border: 1px solid black; padding: 2px; width: fit-content; margin-bottom: 5px;">Addition</div> Page 6-1 <div style="border: 1px solid black; padding: 2px; width: fit-content; margin-bottom: 5px;">Deletion</div> Section 2.4 "Instructions for Strategic Materials" added
May, 2000	IB (NA) 66053-C	<div style="border: 1px solid black; padding: 2px; width: fit-content; margin-bottom: 5px;">Addition</div> SAFETY PRECAUTIONS, Section 2.3, WARRANTY <div style="border: 1px solid black; padding: 2px; width: fit-content; margin-bottom: 5px;">Correction</div> Chapter 1, Chapter 2, Section 2.2, 3.1, 3.2.1, 3.2.2, 4.1, 5.2, 5.2.1, 5.2.4
July, 2003	IB (NA) 66053-D	<div style="border: 1px solid black; padding: 2px; width: fit-content; margin-bottom: 5px;">Correction</div> SAFETY PRECAUTIONS, Chapter 1, Section 2.2, 4.2, 4.3.2 <div style="border: 1px solid black; padding: 2px; width: fit-content; margin-bottom: 5px;">Addition</div> Conformation to the EMC Directive and Low Voltage Instruction
Nov., 2004	IB (NA) 66053-E	<div style="border: 1px solid black; padding: 2px; width: fit-content; margin-bottom: 5px;">Correction</div> SAFETY PRECAUTIONS, Section 3.1, 3.4.2, 4.1 <div style="border: 1px solid black; padding: 2px; width: fit-content; margin-bottom: 5px;">Addition</div> Section 5.1

INTRODUCTION

Thank you for choosing the Mitsubishi MELSEC-A Series of General Purpose Programmable Controllers. Please read this manual carefully so that the equipment is used to its optimum. A copy of this manual should be forwarded to the end User.

CONTENTS

1. GENERAL DESCRIPTION	1-1
2. SYSTEM CONFIGURATION	2-1 ~ 2-2
2.1 Overall Configuration	2-1
2.2 Applicable System.....	2-2
2.3 Precautions for Using Two Channels with A62DA.....	2-2
3. SPECIFICATIONS	3-1 ~ 3-12
3.1 General Specifications	3-1
3.2 Performance Specifications	3-2
3.2.1 Performance specifications	3-2
3.2.2 I/O conversion characteristics	3-3
3.3 I/O List with Respect to Programmable Controller CPU	3-9
3.3.1 I/O list	3-9
3.3.2 I/O signals and analog output	3-10
3.4 Buffer Memory.....	3-11
3.4.1 Assignment of buffer memory	3-11
3.4.2 Contents and data configuration of buffer memory.....	3-11
4. HANDLING	4-1 ~ 4-3
4.1 Handling Instructions.....	4-1
4.2 Nomenclature.....	4-2
4.3 Wiring	4-3
4.3.1 Wiring instructions.....	4-3
4.3.2 Unit connection example.....	4-3
4.4 Maintenance and Inspection	4-3
5. PROGRAMMING	5-1 ~ 5-5
5.1 Initial Setting.....	5-1
5.2 Programs.....	5-2
5.2.1 Basic programs for read and write	5-2
5.2.2 Write to digital value.....	5-3
5.2.3 Reset of check codes.....	5-4
5.2.4 Application circuit examples.....	5-4

6. TEST OPERATION AND ADJUSTMENTS	6-1 ~ 6-4
6.1 Offset/Gain Setting.....	6-1
6.2 Check Points before Start of Operation	6-4
7. TROUBLESHOOTING	7-1 ~ 7-4
7.1 Troubleshooting Flow Chart.....	7-1
7.2 Flow Chart Used When "RUN" LED Has Flickered or Turned Off.....	7-2
7.3 Flow Chart Used When Analog Output Is Not Provided Properly.....	7-3
APPENDIX	APP-1
External View	APP-1

Conformation to the EMC Directive and Low Voltage Instruction

For details on making Mitsubishi PLC conform to the EMC directive and low voltage instruction when installing it in your product, please see Chapter 3, "EMC Directive and Low Voltage Instruction" of the User's Manual (Hardware) of the PLC CPU to use.

The CE logo is printed on the rating plate on the main body of the PLC that conforms to the EMC directive and low voltage instruction.

By making this product conform to the EMC directive and low voltage instruction, it is not necessary to make those steps individually.

1. GENERAL DESCRIPTION

This User's Manual describes the specifications, handling, programming procedures, etc. of the A62DA digital-analog converter module (hereinafter referred to as "A62DA") which is used in combination with the MELSEC-A series CPU module.

The CPU types are generically labeled as follows in this User's Manual.

(1) PLC CPU

A0J2(H)CPU
A1CPU, A2CPU(S1), A3CPU
A1NCP, A2NCP(S1), A3NCP
A2ACP(S1), A3ACP
A2UCP(S1), A3UCP, A4UCP
Q2ACP(S1), Q3ACP, Q4ACP,
A3HCP, A3MCP, K2ACP

(2) Building-block type CPU

A1CPU, A2CPU(S1), A3CPU
A1NCP, A2NCP(S1), A3NCP
A2ACP(S1), A3ACP
A2UCP(S1), A3UCP, A4UCP
Q2ACP(S1), Q3ACP, Q4ACP
A3HCP, A3MCP, K2ACP

(3) Compact-type CPU

A0J2(H)CPU

(4) ACP

A1CPU, A2CPU(S1), A3CPU
A1NCP, A2NCP(S1), A3NCP
A2ACP(S1), A3ACP
A2UCP(S1), A3UCP, A4UCP
Q2ACP(S1), Q3ACP, Q4ACP
A3HCP, A3MCP

Refer to the User's Manual, Programming Manual and Data Link Reference Manual for each CPU module as required when using the A62DA.

POINT

In this manual, the I/O assignment numbers of the A62DA with respect to the programmable controller CPU assume that the A62DA is loaded into slot No. 0 of the main base unit. When the A62DA is loaded into a slot other than slot No.0, determine the assignment number according to the I/O assignment method as given in the Programming Manual.

2. SYSTEM CONFIGURATION

2.1 Overall Configuration

The overall configuration of A series equipped with the A62DA is shown in Fig. 2.1.

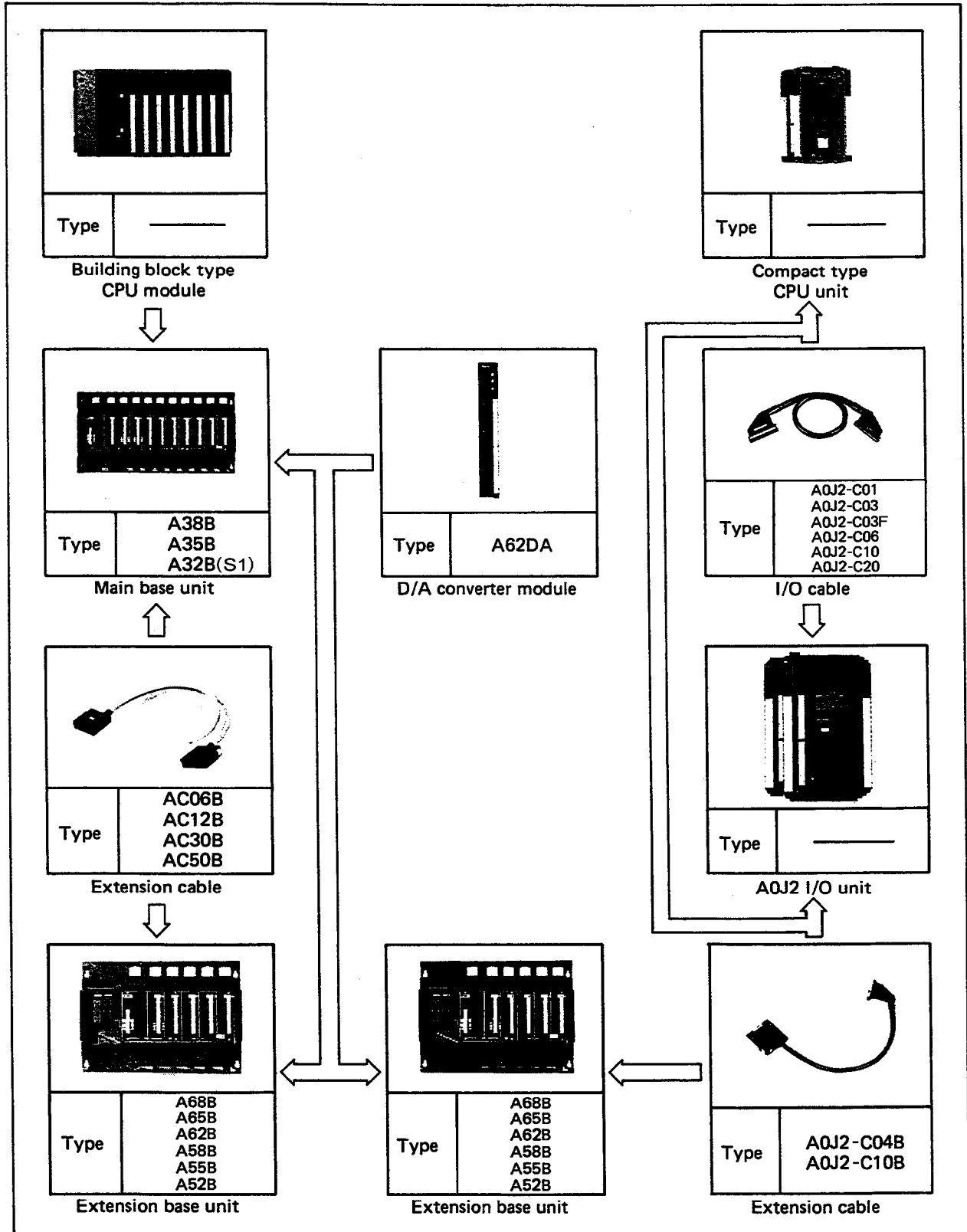

2. SYSTEM CONFIGURATION

2.2 Applicable System

The A62DA can be used for the following CPU modules:

Applicable models	A0J2CPU	A0J2HCPU	A1CPU	A2ACPU
	A2CPU	A2ACPU-S1	A2CPU-S1	A3ACPU
	A3CPU	A2UCPU	A1NCP	A2UCPU-S1
	A2NCP	A3UCPU	A2NCP-S1	A4UCPU
	A3NCP	Q2ACPU	A3HCP	Q2ACPU-S1
	A3MCP	Q3ACPU	K2ACPU	Q4ACPU

The A62DA can be loaded into any slot of the base unit except in the following cases:

- (1) Avoid loading the A62DA into an extension base (Type A5 □ extension base unit) without a power supply module because power capacity may become insufficient. If the A62DA is loaded into such an extension base, refer to Section 3.4 to Section 3.5 of CPU User's Manual for data on the selection of power supply module and extension cable.
- (2) For the processing time (read and write) with the A62DA in a data link system, refer to the data link User's Manual.

Master station	A0J2HCPUP21/R21	A1CPUP21/R21	A2CPU21/R21
	A2CPUP21/R21-S1	A3CPUP21	A1NCPUP21(S3)/R21
	A2NCPUP21(S3)/R21	A2NCPUP21-S1(S4)/R21-S1	A3NCPUP21(S3)/R21
	A2ACPUP21(S3)/R21	A2ACPUP21-S1(S4)/R21-S1	A3ACPUP21(S3)/R21
	A2UCPU	A2UCPU-S1	A3UCPU
	A4UCPU	Q2ACPU	Q2ACPU-S1
	Q3ACPU	Q4ACPU	A3HCPUP21/R21
	A3MCPUP21/R21	A73CPUP21/R21	
Master station	A0J2CPUP23/R23	A1CPUP21/R21	A2CPU21/R21
	A0J2HCPUP21/R21	A3CPUP21	A1NCPUP21(S3)/R21
	A2CPUP21/R21-S1	A2NCPUP21-S1(S4)/R21-S1	A3NCPUP21(S3)/R21
	A2NCPUP21(S3)/R21	A2ACPUP21-S1(S4)/R21-S1	A3ACPUP21(S3)/R21
	A2ACPUP21(S3)/R21	A2UCPU-S1	A3UCPU
	A2UCPU	Q2ACPU	Q2ACPU-S1
	A4UCPU	Q4ACPU	A3HCPUP21/R21
	Q3ACPU	A73CPUP21/R21	
	A3MCPUP21/R21		
Remote station	AJ71P25/R25		

- (3) When use with A3CPU(P21/R21), cannot installed at final slot of the 7th extension base.

Refer to the Data Link System User's Manual for details on the processing time (reading, writing) when using the A62DA in the data link system.

2.3 Precautions for Using Two Channels with A62DA

The output terminal and PLC power supply are insulated with photo couplers for the A62DA. However, the analog output ground is connected internally. Thus, the "-V" and "-I" for each channel will have the same level.

3. SPECIFICATIONS

This chapter describes the general specifications and performance specifications of the A62DA.

3.1 General Specifications

The general specifications of A62DA are indicated in Table 3.1.

Item	Specifications					
Operating ambient temperature	0 to 55°C					
Storage ambient temperature	-20 to 75°C					
Operating ambient humidity	10 to 90%RH, non-condensing					
Storage ambient humidity	10 to 90%RH, non-condensing					
Vibration resistance	Conforming to JIS B 3502, IEC 61131-2		Frequency	Acceleration	Amplitude	Sweep count 10 times each in X, Y, Z directions (for 80 min.)
		Under intermittent vibration	10 to 57 Hz	—	0.075 mm (0.003 in.)	
			57 to 150 Hz	9.8m/s ²	—	
		Under continuous vibration	10 to 57 Hz	—	0.035 mm (0.001 in.)	
57 to 150 Hz	4.9m/s ²		—			
Shock resistance	Conforming to JIS B 3502, IEC 61131-2 (147m/s ² , 3 times each in X, Y, Z directions)					
Noise durability	By noise simulator of 1500Vpp noise voltage, 1 μs noise width and 25 to 60Hz noise frequency					
Dielectric withstand voltage	1500V AC for 1 minute across AC external terminals and ground					
Insulation resistance	5MΩ or larger by 500V DC insulation resistance tester across AC external terminals and ground					
Operating ambience	No corrosive gas					
Operating height *3	2000 m (6562 ft.) max.					
Installation location	Inside the control panel					
Overvoltage category *1	II or less					
Pollution rate *2	2 or less					
Cooling method	Self-cooling					

Table 3.1 General Specifications

- *1: Indicates the distribution area where the device is assumed to be connected, from the public power distribution network to the local machine device.
Category II is applied to the devices to which the power is supplied from a fixed equipment.
The surge resistance voltage of a rated 300 V device is 2500 V.
- *2: This is an index which Indicates the occurrence rate of the conductive object in the anvironment where the device is used.
Pollution rate II indicates that only non-conductive pollution may occur with a possiblility of generating temporary conductivity due to accidental condensation.
- *3: Do not use or store the PLC under pressure higher than the atmospheric pressure of altitude 0m.
Doing so can cause a malfunction.
When using the PLC under pressure, please contact your sales representative.

3.2 Performance Specifications

This section describes the performance specifications and I/O conversion characteristics of A62DA.

3.2.1 Performance specifications

The performance specifications of A62DA are indicated in Table 3.2.

Table 3.2 Performance Specifications

Item	Specifications																				
Digital input	Voltage output, digital setting range: ± 2000 Current output, digital setting range: ± 1000 For data configuration and setting procedure, refer to Section 3.4.2 (page 3-10).																				
Analog input	Selectively used depending on output terminals. Voltage: -10 to 0 to $+10V$ DC (External load resistance: 500Ω to $1M\Omega$) Current: $+4$ to $+20mA$ DC (External load resistance: 0Ω to 600Ω) -20 to 0 to $+20mA$ can also be used for current output.																				
I/O characteristics	<table border="1"> <thead> <tr> <th rowspan="2">Digital Input</th> <th colspan="2">Analog Output</th> </tr> <tr> <th>Voltage</th> <th>Current</th> </tr> </thead> <tbody> <tr> <td>+2000</td> <td>+10V</td> <td>—</td> </tr> <tr> <td>+1000</td> <td>+5V</td> <td>+20mA</td> </tr> <tr> <td>0</td> <td>0V</td> <td>+4mA</td> </tr> <tr> <td>-1000</td> <td>-5V</td> <td>-12mA</td> </tr> <tr> <td>-2000</td> <td>-10V</td> <td>—</td> </tr> </tbody> </table> <p>For details, refer to Section 3.2.2 (page 3-3).</p>	Digital Input	Analog Output		Voltage	Current	+2000	+10V	—	+1000	+5V	+20mA	0	0V	+4mA	-1000	-5V	-12mA	-2000	-10V	—
Digital Input	Analog Output																				
	Voltage	Current																			
+2000	+10V	—																			
+1000	+5V	+20mA																			
0	0V	+4mA																			
-1000	-5V	-12mA																			
-2000	-10V	—																			
Maximum resolution	Voltage: $5mV$ ($1/2000$) Current: $20\mu A$ ($1/1000$)																				
Overall accuracy*	$\pm 1\%$ (voltage: $\pm 0.1V$, current: $\pm 0.2mA$)																				
Maximum conversion speed	Within $15ms/2$ channels (Time for 1 channel is also the same.) <i>Note: Time from when digital input is written to when analog voltage (current) changes from $-10V$ ($-20mA$) to $+10V$ ($+20mA$).</i>																				
Absolute maximum output	Voltage: $\pm 12V$ <i>Note: Max. output voltage and current restricted by output protection circuit.</i> Current: $\pm 28mA$																				
Number of analog output points	2 channels/module																				
Insulation method	Photocoupler insulation between output terminals and PC power (Non-insulated between channels)																				
Number of I/O occupying points	Special 32 points																				
Connection terminal	20-point terminal block																				
Applicable wire size	0.75 to $2mm^2$ (Applicable tightening torque: 39 to $59N\cdot cm$)																				
Applicable solderless terminal	V1.25-3, V1.25-YS3A, V2-S3, V2-YS3A																				
Internal current consumption (5V DC)	0.6A																				
External supply power	Voltage	21.6 to $26.4V$ DC																			
	Current consumption	0.35A																			
	Inrush current	2.4A																			
Weight	0.5kg (1.1lb)																				

* This is the accuracy in respect to the maximum analog output value.

POINT

The analog output ranges for maximum resolution and maximum overall accuracy, is from -10 to 0 to $+10V$ or from -20 to 0 to $+20mA$.

3.2.2 I/O conversion characteristics

I/O conversion characteristics are indicated by an inclination which is connected between an offset value and a gain value set in the test mode. Fig. 3.1 shows an example at the time of voltage output.

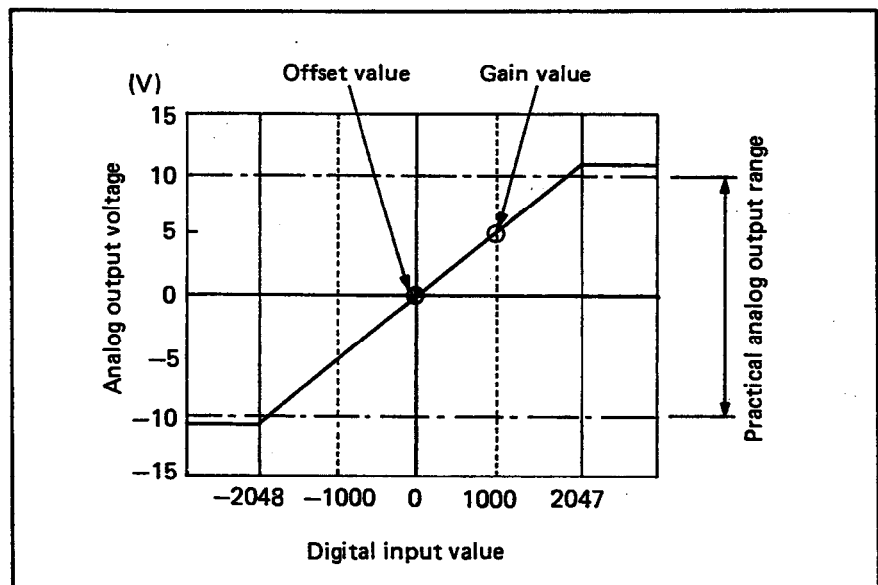

Fig. 3.1 I/O Conversion Characteristics

REMARKS

1. The offset value is the analog output voltage or current which is provided when the digital input value is 0. Set the offset value in test mode.
2. The gain value is the analog output voltage or current which is provided when the digital input value is 1000. Set the gain value in test mode.

(1) Voltage output characteristic

Fig. 3.2 shows a voltage output characteristic example for several offset/gain settings.

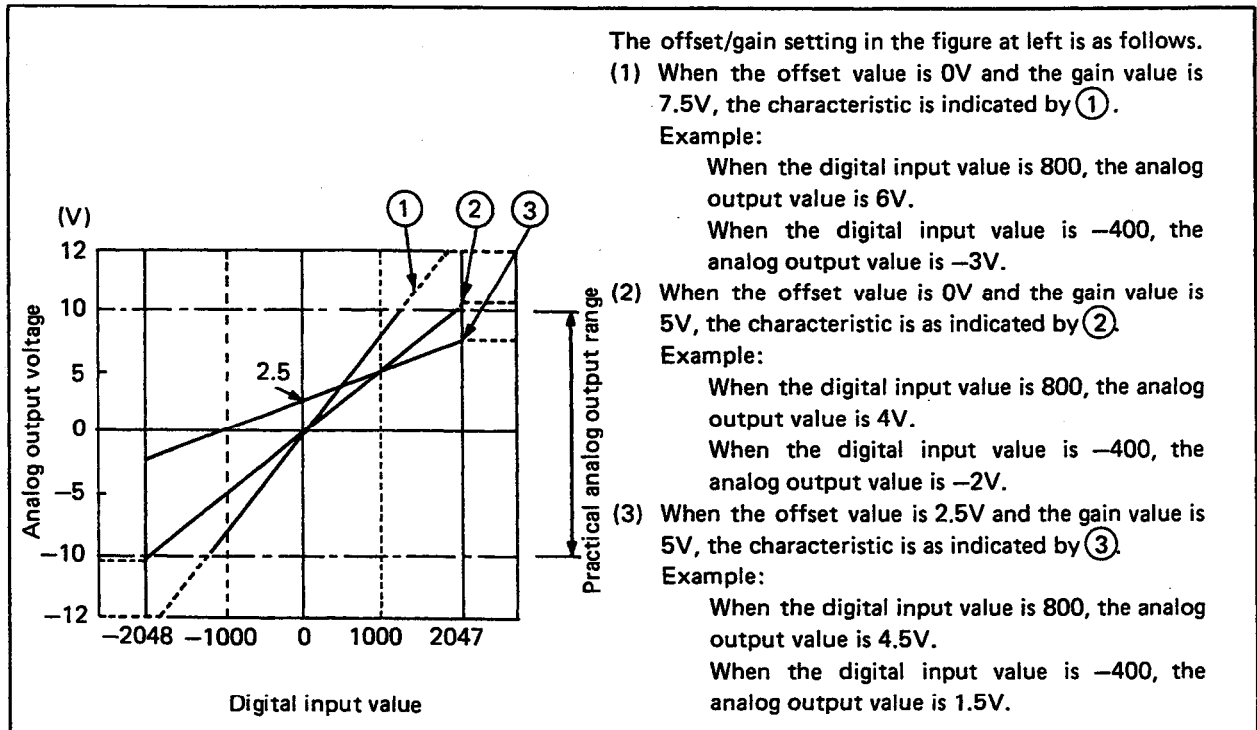

Fig. 3.2 Voltage Output Characteristic

POINT

- The maximum resolution and overall accuracy are within the range of performance specifications when the working analog output range is -10 to 0 to +10V. Avoid use outside the above indicated range (dotted line on the voltage output characteristic graph in Fig. 3.2).
If the unit is used outside the practical analog output range, note the following:
 - Prolonged use may lead to excessive rise in temperature and failure of the module.
 - Accuracy may not be within the range of performance specifications.
- When the digital input value has been set to less than -2048 or more than +2047, analog output is provided with the digital input value regarded as -2048 or +2047.
- The A62DA limits the maximum output voltage to -12 or +12V to protect against short circuit at the outputs. Therefore, even if the digital input value is set outside the range of output voltage limits, the output signal is limited to the maximum indicated.

(2) Current output characteristic

Fig. 3.3 shows a current output characteristic graph for several offset/gain settings.

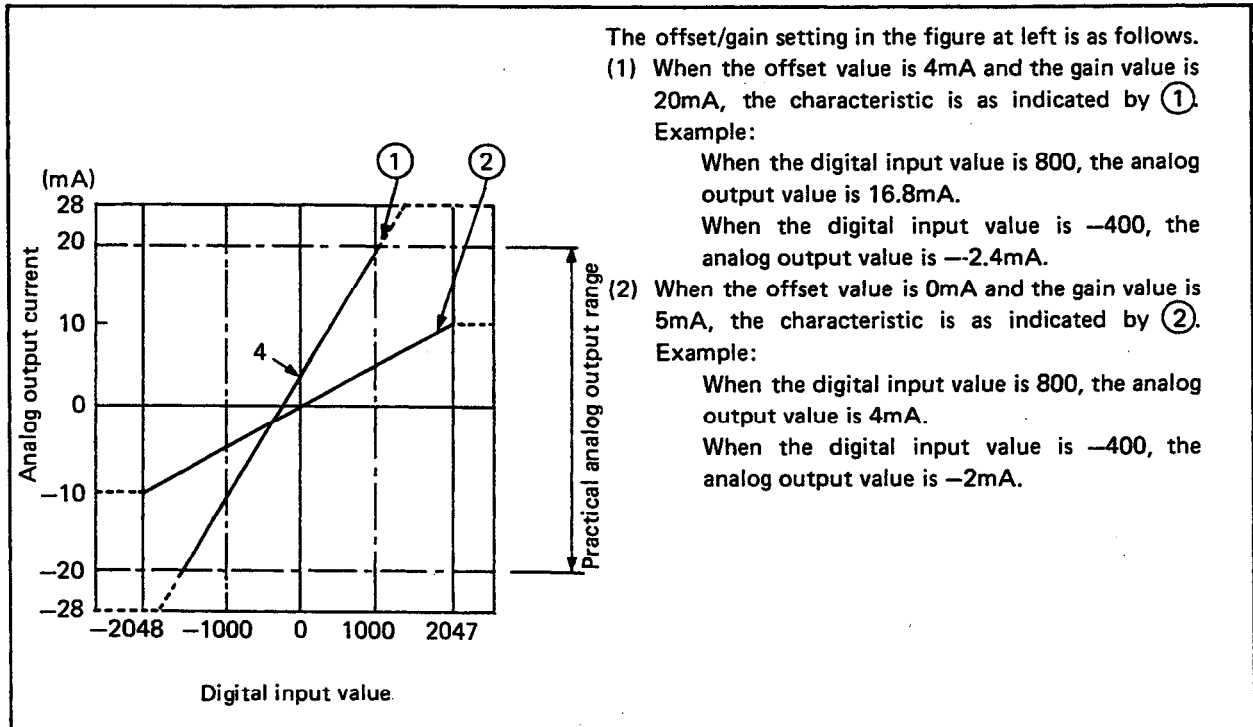

Fig. 3.3 Current Output Characteristic

POINT

1. The maximum resolution and overall accuracy are within the range of performance specifications when the working analog current range is -20 to 0 to +20mA. Avoid use outside the above indicated range (dotted line on the current output characteristic graph in Fig. 3.3).
 If the unit is used outside the practical analog output range, note the following:
 - 1) Prolonged use may result in excessive rise of temperature and failure of the module.
 - 2) Accuracy may not be within the range of performance specifications.
2. When the digital input value has been set to less than -2048 or more than +2047, analog output is provided with the digital input value regarded as -2048 or +2047.
3. The A62DA limits the maximum output current to -28mA or +28mA to protect against short circuits at the outputs. Therefore, even if the digital input value is set outside the range of output current limits, the output signal is limited to the maximum indicated.

(3) Relation between offset/gain setting and analog output value

The resolution of the A62DA can be changed by the offset/gain setting. To calculate the resolution and analog output values for various digital input value, use the following expressions.

$$(\text{Resolution}) = \frac{(\text{gain value}) - (\text{offset value})}{1000}$$

$$\begin{aligned} (\text{Analog output}) &= \frac{(\text{gain value}) - (\text{offset value})}{1000} \times (\text{digital input value}) \\ &\quad + (\text{offset value}) \\ &= (\text{resolution}) \times (\text{digital input value}) + (\text{offset value}) \end{aligned}$$

If the resolution is in units of 5mV or 20 μ A, the variation of analog output value differs depending on the setting of offset and gain for a change of 1 in the digital input value.

Fig. 3.4 and 3.5 show the relation between the digital input value and the analog output value when the offset/gain setting is changed. The offset value and gain value are values in the voltage and current output characteristic graphs in Fig. 3.2 and 3.3.

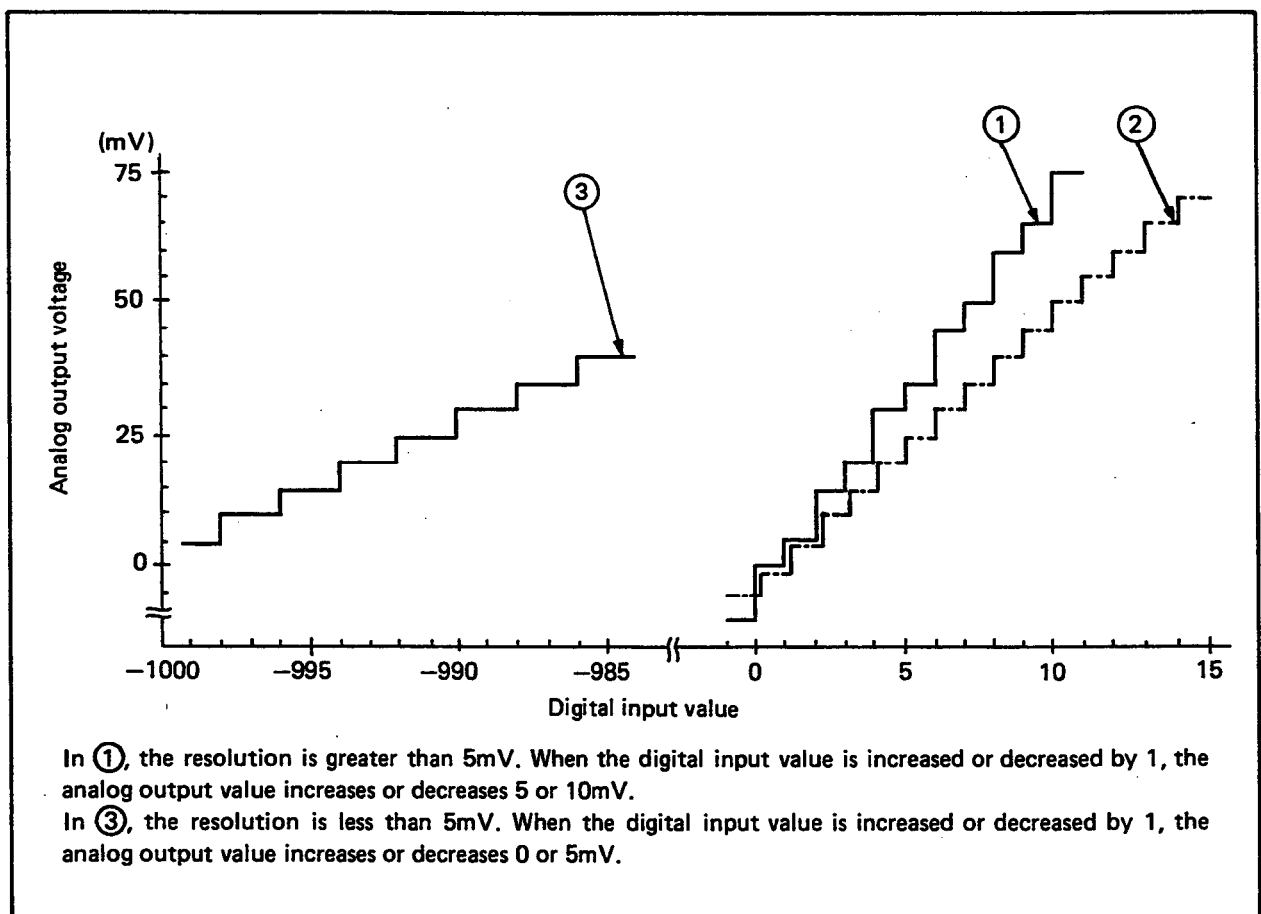

Fig. 3.4 Digital Input Value and Voltage Output

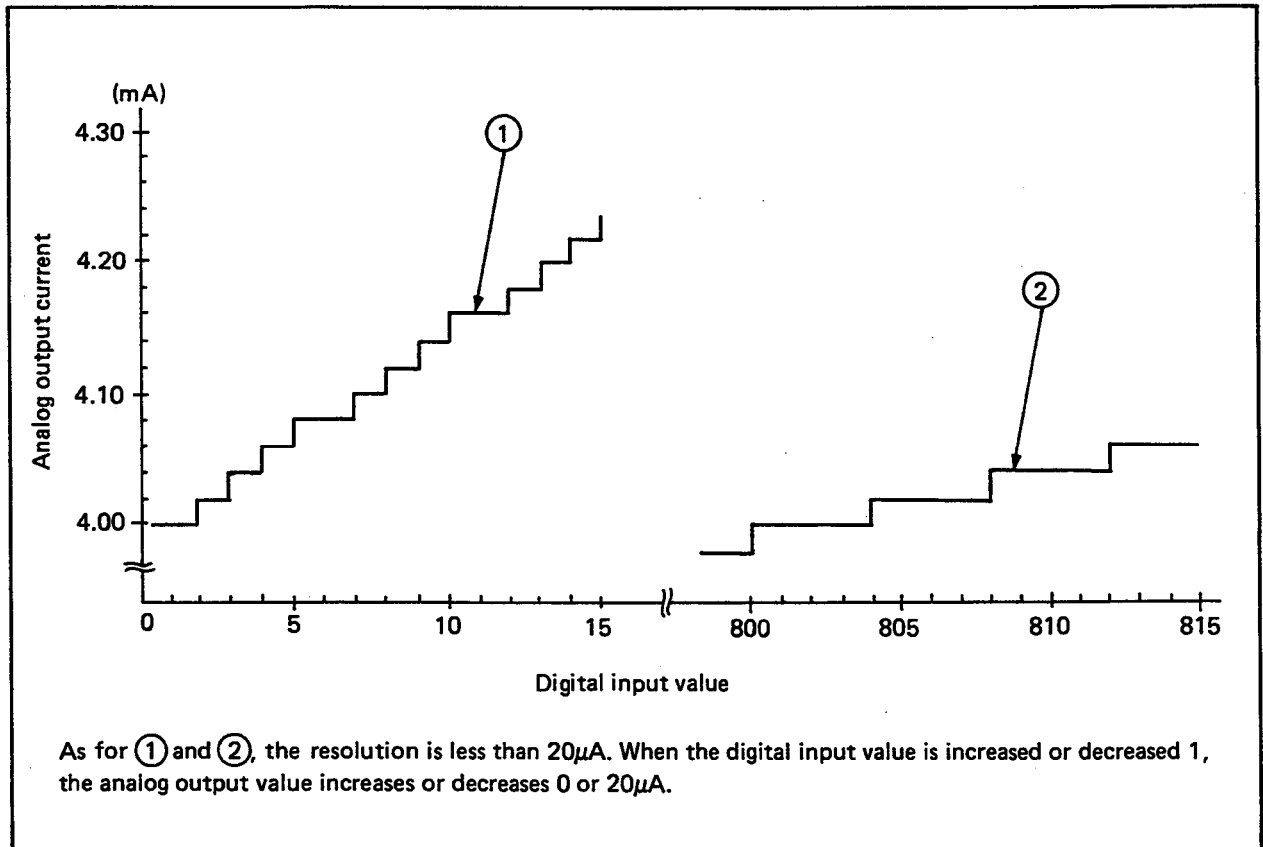

Fig. 3.5 Digital Input Value and Current Output

(4) Overall accuracy

The overall accuracy is the accuracy in respect to the maximum analog output value.

Even if the input characteristics are changed by changing the offset/gain settings, the overall accuracy will not change and will be kept within the range of the performance specifications. The overall accuracies of the power/current output characteristics are shown in Fig. 3.6 and Fig. 3.7.

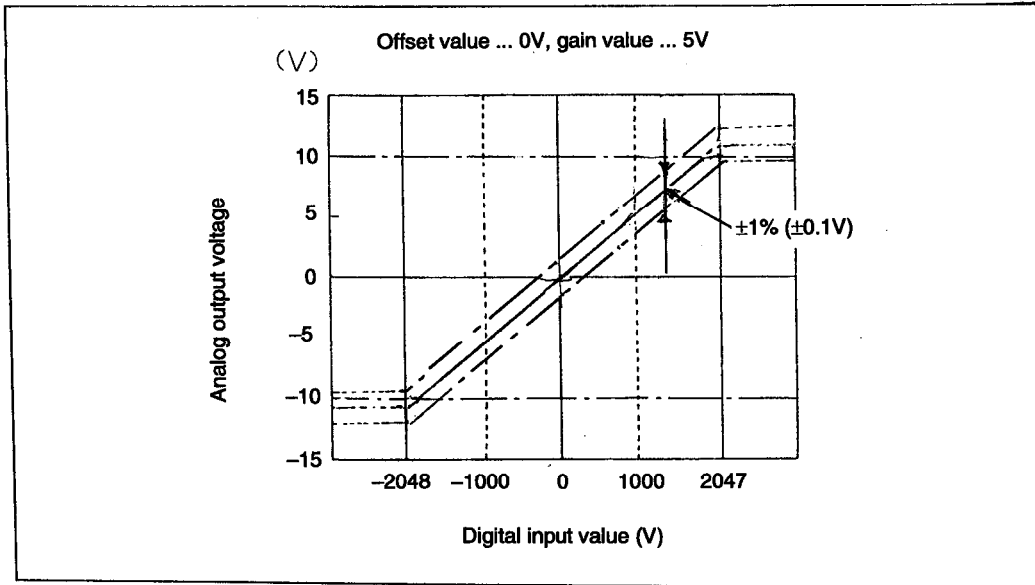

Fig. 3.6 Overall accuracy of voltage output characteristics

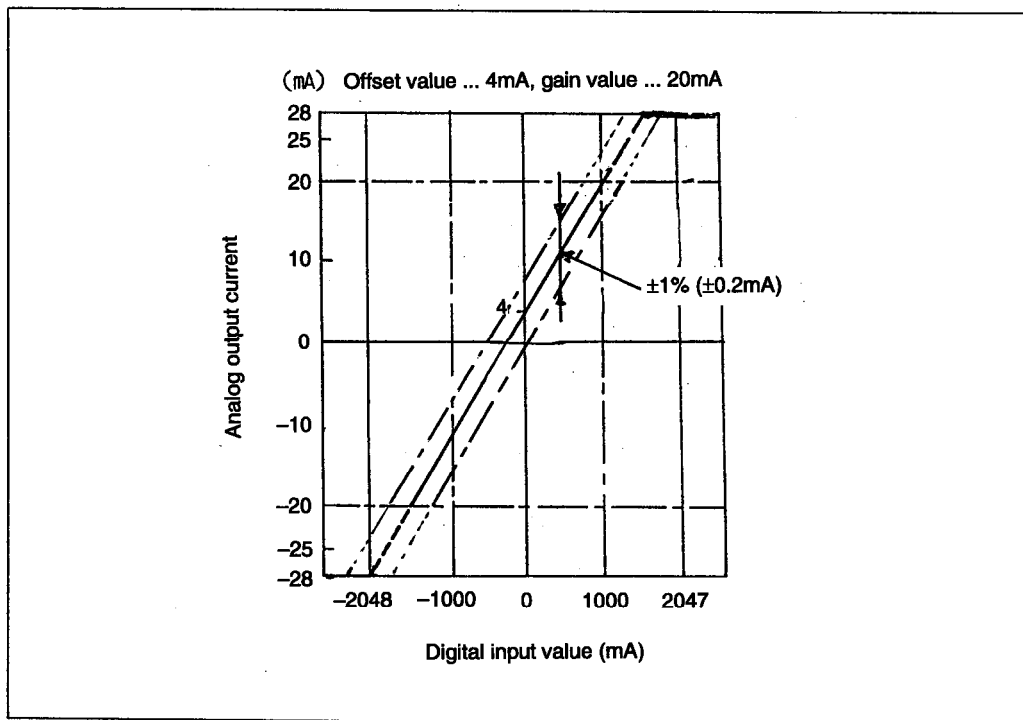

Fig. 3.7 Overall accuracy of current output characteristics

3.3 I/O List with Respect to Programmable Controller CPU

The I/O signals for the A62DA with respect to the programmable controller CPU are as indicated below. Numbers provided for X and Y are determined by the loading position of the A62DA module and the number of points of other I/O units.

The I/O numbers indicated below are used when the A62DA module is loaded into the slot No. 0 of main base unit.

3.3.1 I/O list

(1) Inputs for programmable controller CPU X0 – X1F (32 points).

Input Signal	Description
X0	Watch dog timer error Turns on if a watch dog timer error occurs in the A62DA.
X1	D/A conversion ready (1) Turns on when D/A conversion is ready in normal mode (not in test mode) after the power is turned on or the programmable controller CPU is reset. Turns off when normal mode is changed to test mode. (2) Used as an interlock when read or write is performed from the programmable controller CPU to the A62DA.
X2 to X1F	Not used

(2) Outputs for programmable controller CPU Y0 – Y1F (32 points).

Output Signal	Description
Y0 to Y17	Not used
Y18	CPU select signal (1) OFF a) The digital input of the buffer memory is treated as a 16-bit signed binary and the signs specified by Y19 and Y1A are ignored. (2) ON a) The digital input of the buffer memory is treated as a 16-bit binary and signs are specified by Y19 and Y1A.
Y19	Sign of CH1 digital input
Y1A	Sign of CH2 digital input
Y1B	Output enable Used for both channels 1 and 2. Analog output depends on the signal state. (1) OFF The offset value is output as an analog value. (2) ON The analog value converted from the digital value is output.
Y1C to Y1F	Not used

IMPORTANT

Do not use devices Y0 – Y1A and Y1C – Y1F in the normal sequence program.

Note, however that if the A62DA is used in a remote I/O system, resetting Y0E and Y0F is permitted. For details, refer to the Data Link User's Manual.

3.3.2 I/O signals and analog output

(1) Relation between I/O signals and analog output in normal mode is indicated in the following table.

Output enable Y1B	OFF		ON	
	OFF	ON	OFF	ON
D/A conversion ready X1				
Analog output value	0V	Offset value	0V	The digital value written from the programmable controller CPU, is converted into an analog value which is output.
Remarks		The offset value is output as an analog value.		Until a digital value is written, the offset value is output as an analog value.

(2) In test mode, the D/A conversion ready (X1) signal turns off. Regardless of the digital input value, analog values shown in the following table are output depending on the positions of channel select switch and OFFSET/GAIN select switch.

Position of channel select switch / Channel of analog output		CH1		CH2	
		Channel 1	Channel 2	Channel 1	Channel 2
Position of OFFSET/GAIN select switch	OFFSET position	Offset value of channel 1	Offset value of channel 2	Offset value of channel 1	Offset value of channel 2
	SET position				Gain value of channel 2
	GAIN position	Gain value of channel 1			Gain value of channel 2

3.4 Buffer Memory

The A62DA is equipped with a buffer memory (which is not battery backed) for the communication of data with the programmable controller CPU. The following gives an explanation of the assignment and data configuration of this buffer memory.

For read and write of data by the sequence program, refer to Chapter 6 (page 6-1).

3.4.1 Assignment of buffer memory

The assignment of buffer memory is indicated below.

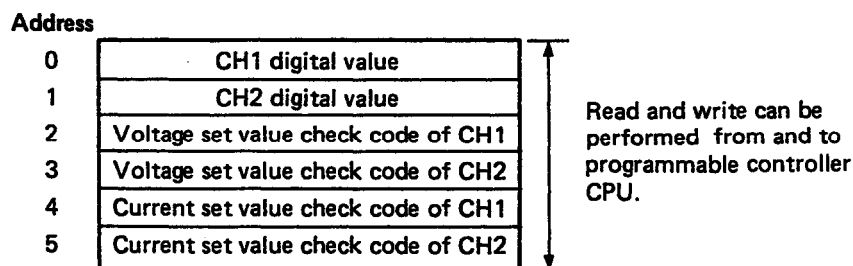

*Each data consists of 16 bits.

3.4.2 Contents and data configuration of buffer memory

This section describes the contents and data configuration of the buffer memory for each item indicated in Section 3.4.1.

(1) Digital value (CH1, CH2)

- a) When the power is turned on and the D/A conversion ready signal is on, the digital value is 0.
- b) For the A series-CPU's (CPU select signal off), set a digital value, -2048 to $+2047$, in 16-bit binary with sign.

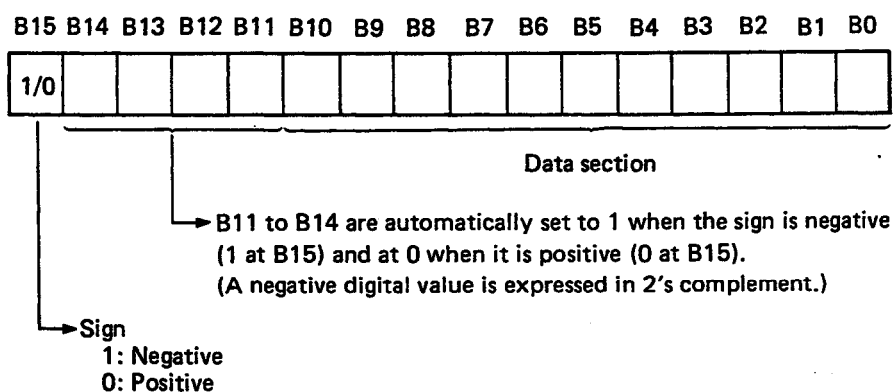

POINT

If the digital value has been set outside its range, D/A conversion is made with the set value regarded as the usable maximum value or minimum value.

Example: When -3000 is set to the A series CPU, the value is treated as -2048 .

When $+3000$ is set, it is treated as $+2047$.

(2) Voltage set value check (CH1, CH2)

When the digital value is set to -2001 or less or to $+2001$ or more, one of the following check codes is set for each channel.

Check Code	Description
000F	The digital value has been set to $+2001$ or more.
00F0	The digital value has been set to -2001 or less.
00FF	The digital value is outside the range -2000 to $+2000$. For example, after setting a digital value of $+2001$ or greater, setting another value of -2001 or less without resetting the check code will store check code 00FF.

*Check codes are expressed in hexadecimal.

(3) Current set value check (CH1, CH2)

When the digital value is set to a negative value or to $+1001$ or more, one of the following check codes is set for each channel.

Check Code	Description
000F	The digital value has been set to $+1001$ or more.
00F0	The digital value has been set to a negative value.
00FF	The digital value is outside the range 0 to $+1000$. For example, after setting a digital value of $+1001$ or greater, setting any negative value without resetting the check code will store check code 00FF.

*Check codes are expressed in hexadecimal.

POINT

1. If the digital value is a negative value or $+1001$ or more in the case of analog voltage output, the current set value check codes will be set to 4 (CH1) and 5 (CH2) of buffer memory.

2. Reset the check codes by use of the sequence program in the programmable controller CPU. For details, refer to Chapter 6 (page 6-1).

4. HANDLING

This chapter describes the handling instructions, nomenclature, maintenance, and inspection of the A62DA.

4.1 Handling Instructions

- (1) Protect the A62DA and its terminal block from impact.
- (2) Do not touch or remove the printed circuit board from the case.
- (3) When wiring, ensure that no wire offcuts enter the module and remove any that do enter.
- (4) Tighten terminal screws as specified below.

Screw	Tightening Torque Range
I/O terminal block terminal screw (M3 screw)	39 to 59 N·cm
I/O terminal block mounting screw (M4 screw)	78 to 118 N·cm

- (5) To load the module onto the base, press the module against the base so that the hook is securely locked. To unload the module, push the catch on the top of the module, and after the hook is disengaged from the base, pull the module toward you.

4.2 Nomenclature

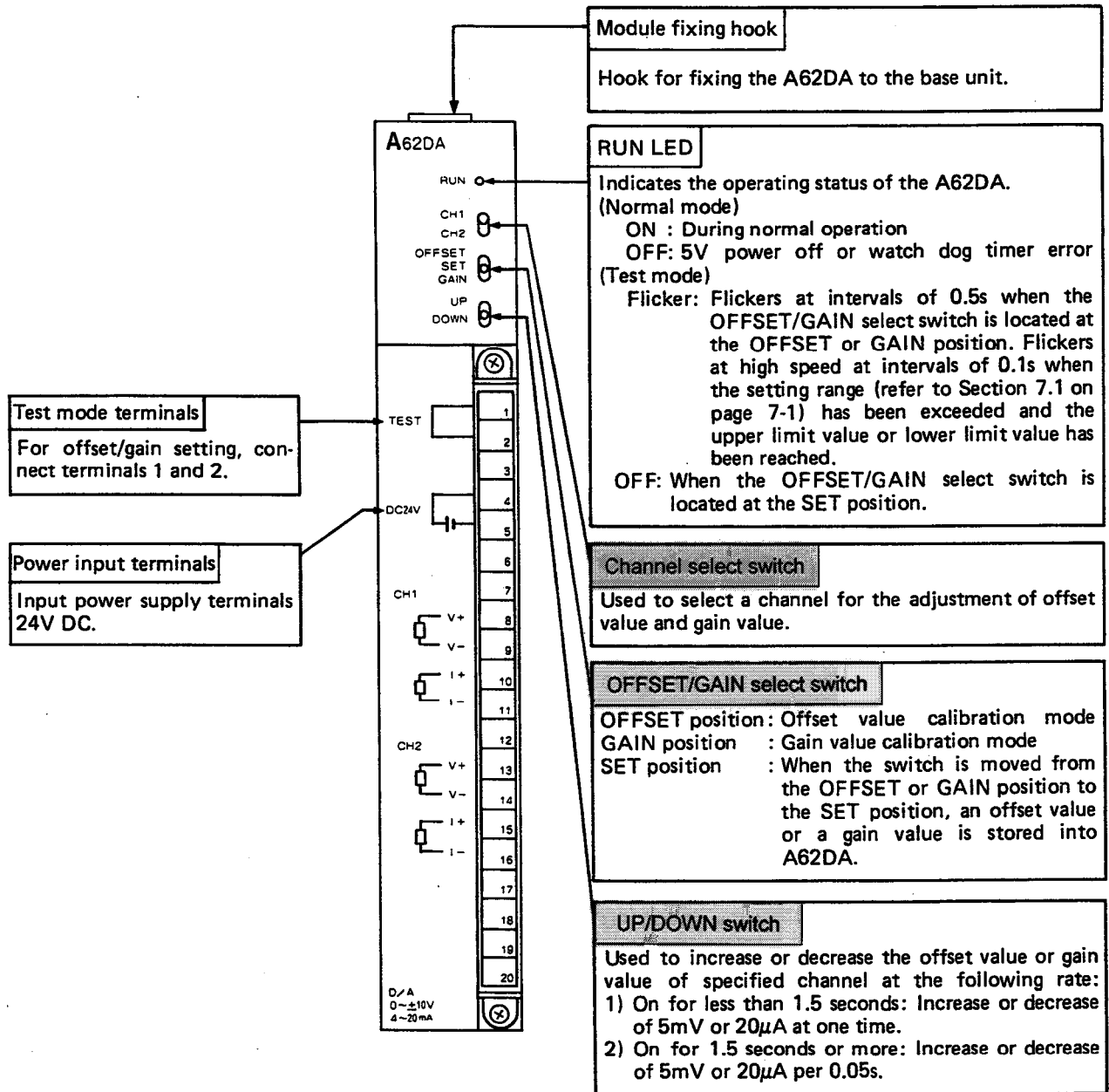

Switches marked  are valid only in test mode. For details, refer to Section 6.1 (page 6-1).

Terminal No.	Signal name	Terminal No.	Signal name	Terminal No.	Signal No.
1	TEST	8	CH1 V+	15	CH2 I+
2	TEST	9	CH1 V-	16	CH2 I-
3	Vacancy	10	CH1 I+	17	Vacancy
4	DC24V+	11	CH1 I-	18	Vacancy
5	DC24V-	12	Vacancy	19	Vacancy
6	Vacancy	13	CH2 V+	20	Vacancy
7	Vacancy	14	CH2 V-	—	—

4.3 Wiring

4.3.1 Wiring instructions

Protect external wiring against noise with the following precautions:

- (1) Separate AC and DC wiring.
- (2) Separate main circuit and/or high voltage wiring from control and signal wiring.
- (3) Where applicable, ground the shielding of all wires to a common ground point.

4.3.2 Unit connection example

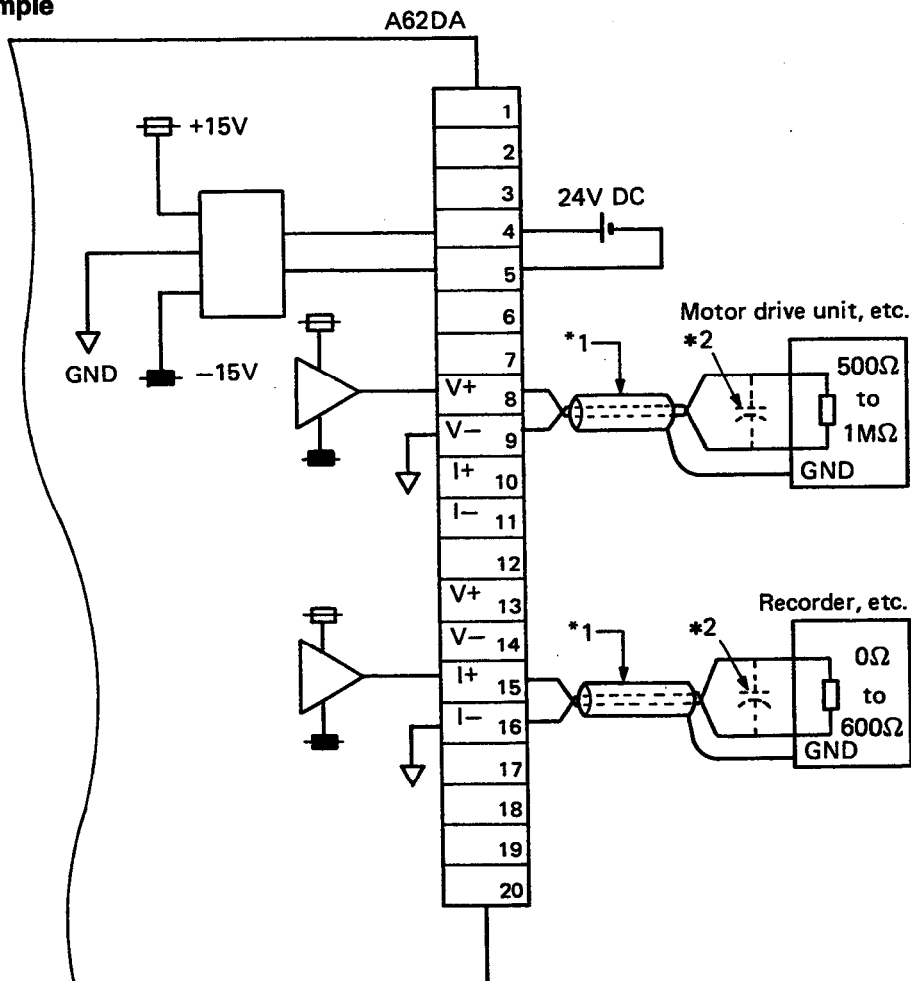

*1: Use two core, shielded wiring (twisted).

*2: If noise or ripple is generated by the external wiring, connect a 0.1 to 0.47μF (25V or more voltage resistance parts.) capacitor to the input terminal of external equipment.

IMPORTANT

A given channel cannot be used for voltage and current outputs at the same time. Only use one set of terminals on each channel.

4.4 Maintenance and Inspection

No special maintenance requirements apply to the A62DA. For general maintenance refer to the ACPU User's Manual.

5. PROGRAMMING

5.1 Initial Setting

This section describes a programming procedure for using the A62DA. Perform the initial setting of A62DA from the programmable controller CPU in the procedure shown in Fig. 6.1.

When applying any of the program examples introduced in this chapter to the actual system, verify the applicability and confirm that no problems will occur in the system control.

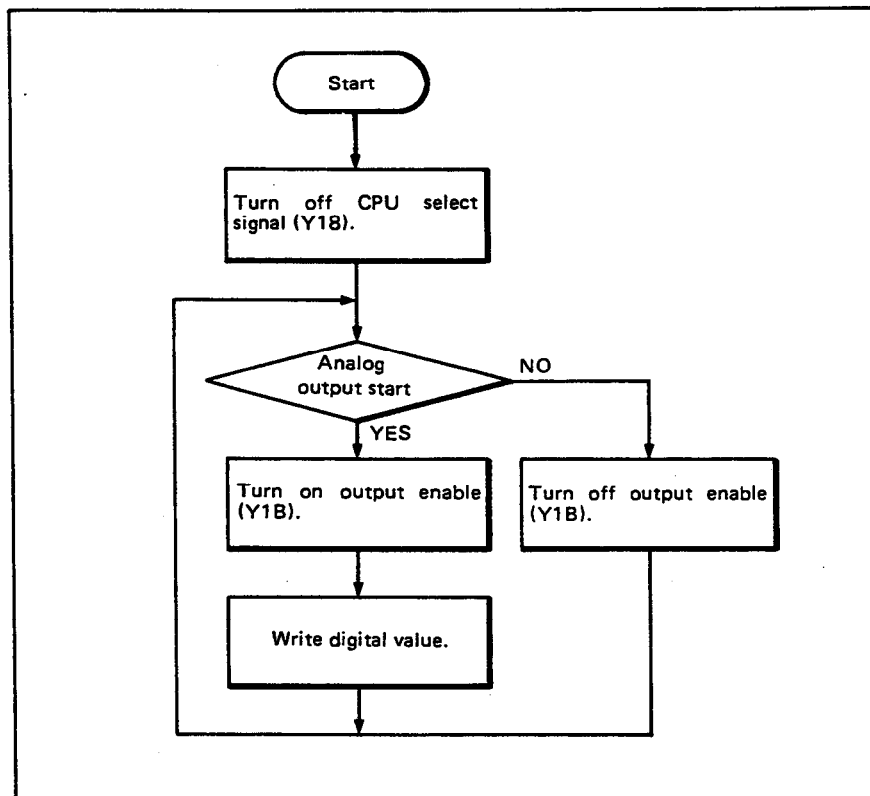

Fig. 5.1 Initial Setting Procedure

I/O numbers shown below are applicable when the A62DA is loaded in slot No. 0 of the main base unit, unless otherwise specified. For I/O numbers with respect to the programmable controller CPU and the assignment of buffer memory, refer to Chapter 3 (page 3-1).

POINT

Determine the interlock conditions in accordance with the system used.

5.2 Programs

Examples of the basic read/write program, reading of the digital value and the application circuit when using the APCU are given in this section.

For details refer to the APCU Programming Manuals or A0J2 Programming Manual. When the module is used for a remote I/O station refer also to the data link User's Manual.

5.2.1 Basic programs for read and write

(1) Read from A62DA: FROM, FROMP, DFRO, DFROP instructions

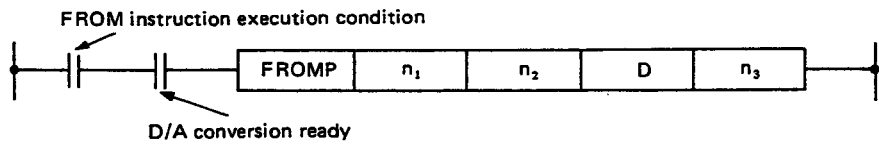

Symbol	Description	Usable Device Number
n ₁	Upper 2 digits of head I/O number assigned to A62DA	K, H
n ₂	Head address of buffer memory which stores data	K, H
D	Head number of device which will store read data	*T,C,D,W,R
n ₃	Number of words of data to be read	K, H

* With the A0J2CPU (P23/R23), only T, C and D can be used.

Example: To read the 2 word data from address 2 of the buffer memory to D0 and 1, with the A62DA assigned to I/O X130 to 14F and Y130 to 14F

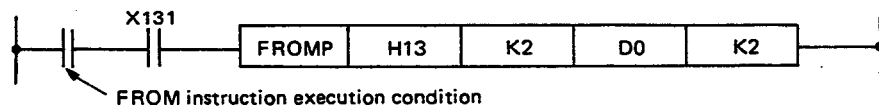

(2) Write to A62DA: TO, TOP, DTO, DTOPT instructions

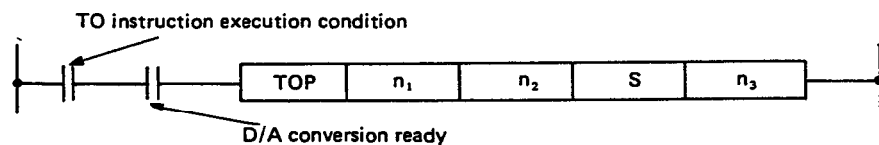

Symbol	Description	Usable Device Number
n ₁	Upper 2 digits of head I/O number assigned to A62DA	K, H
n ₂	Head address of buffer memory which will store data	K, H
D	Head device number or constant where data to be written is stored.	*T, C, D, W R, K, H
n ₃	Number of words of data to be written	K, H

* With the A0J2CPU (P23/R23), only T, C and D can be used.

Example: To write 500 to address 0 of the buffer memory, with the A62DA assigned to I/O X60 to 7F and Y60 to 7F

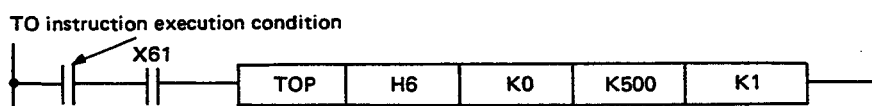

POINT

When using the A0J2CPU (P23/R23), create the program while observing the following points.

- (1) The "FROMP, TOP, DFROP and DTOP" commands cannot be used. Create the pulses using the internal relay (M).
- (2) A constant (K, H) cannot be designated for the TO command. Write the constant by setting data in the T, C and D devices.

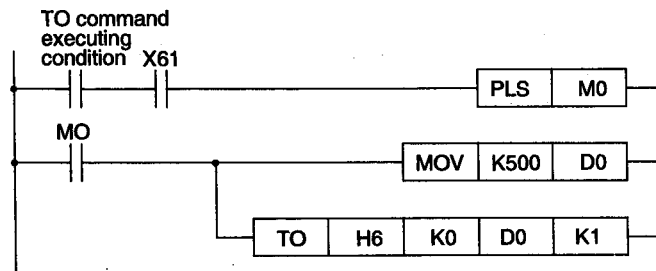

5.2.2 Write of digital value

Writing the contents of data register D5 to channel 1.

(1) Voltage output

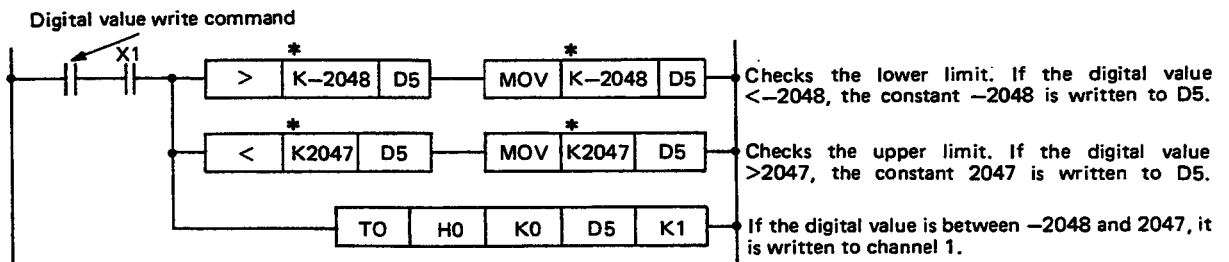

(2) Current output

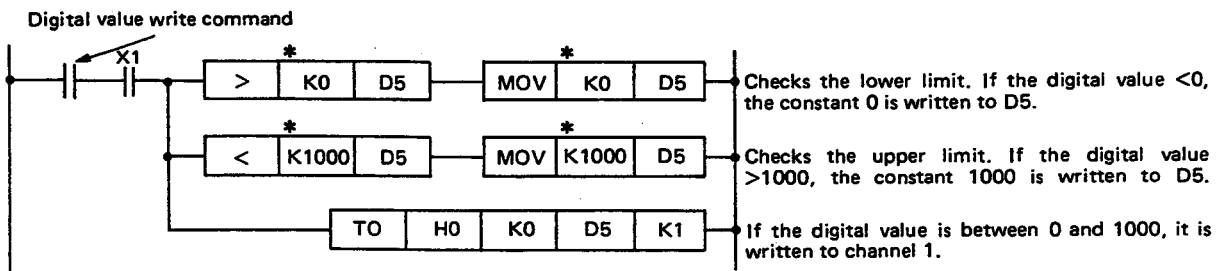

POINT

* Show an example of interlocking within the sequence program. There are many different ways to interlock depending on the program requirements.

5.2.3 Reset of check codes

Batch reset of check codes (addresses 2 to 5 of the buffer memory) of channels 1 and 2.

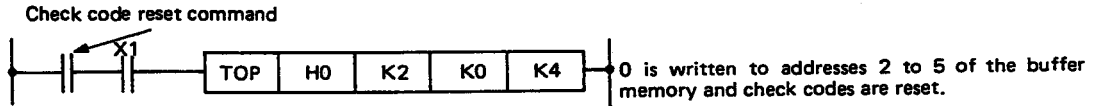

5.2.4 Application circuit examples

An example of the application circuit using the A62DA is shown below.

POINT

The application circuit example is for a basic circuit. Consider the interlock conditions to match the system being used.

- (1) Program giving a voltage analog output from A62DA channel 1 to an inverter for control of 4 set speeds.

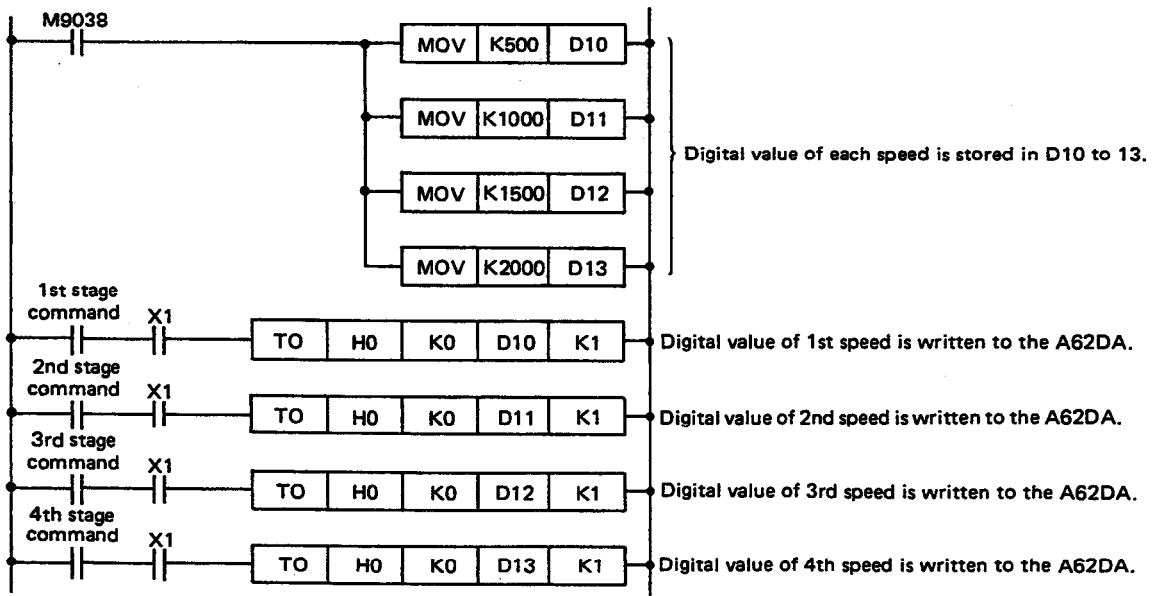

(2) Example which provides output to Y100 and Y101 when a digital value setting error occurs during use of analog current output from channel 1. This example also resets the voltage and current set value check codes of channel 1 when X40 turns on.

Check Code	Y100	Y101
000F	ON	OFF
00F0	OFF	ON
00FF	ON	ON

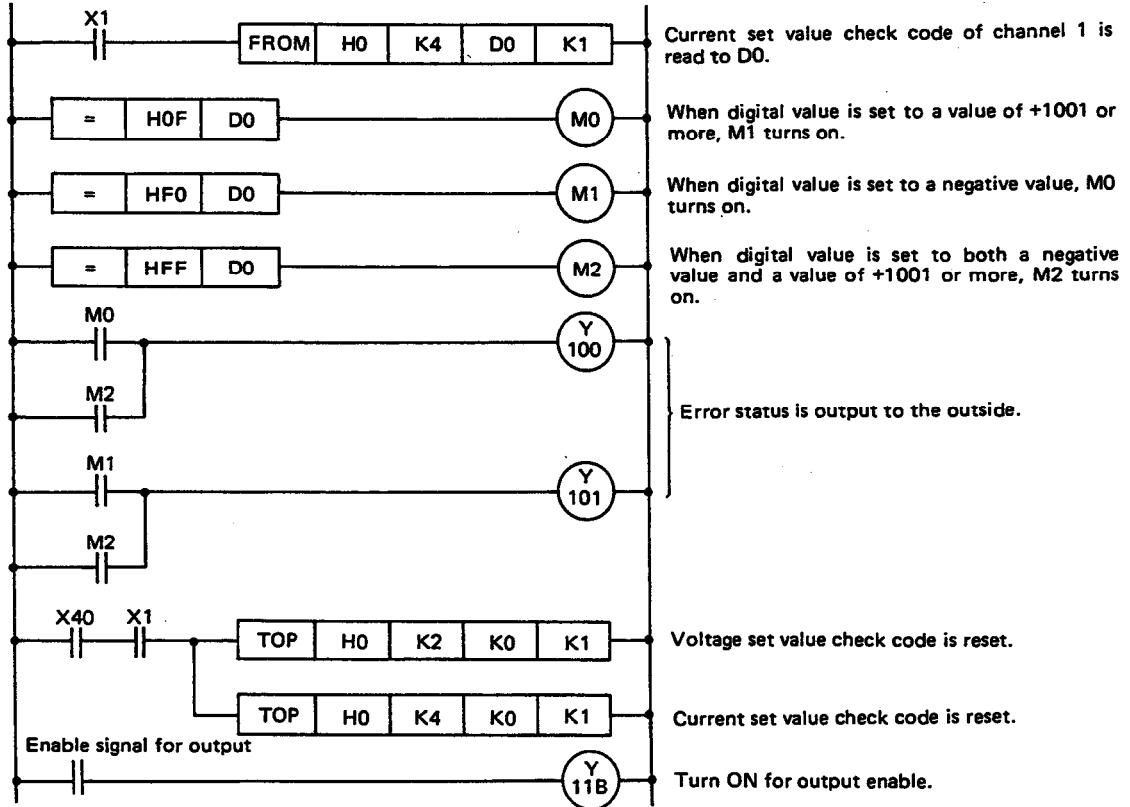

6. TEST OPERATION AND ADJUSTMENTS

6.1 Offset/Gain Setting

The offset/gain setting can be performed in test mode within the following ranges.

	Voltage (V)	Current (mA)
Offset value	-3 to +3 DC	-12 to +12 DC
Gain value	-2 to +10 DC	-8 to +20 DC

Table 7.1 Offset/Gain Setting Range

POINT

1. The setting range of the gain value depends on the offset value as follows:

Gain range = (Offset value + 1) to +10V (Voltage setting)

or

Gain range = (Offset value + 4) to +20mA (Current setting)

Example: If the offset value has been set to 0V, the gain value can be set within the range +1 to +10V.

2. If offset (gain value) adjustment is taken outside the range shown in Table 7.1, the RUN LED flickers faster (0.1sec.)
3. When turn off power, however offset value and gain value are remained internally.

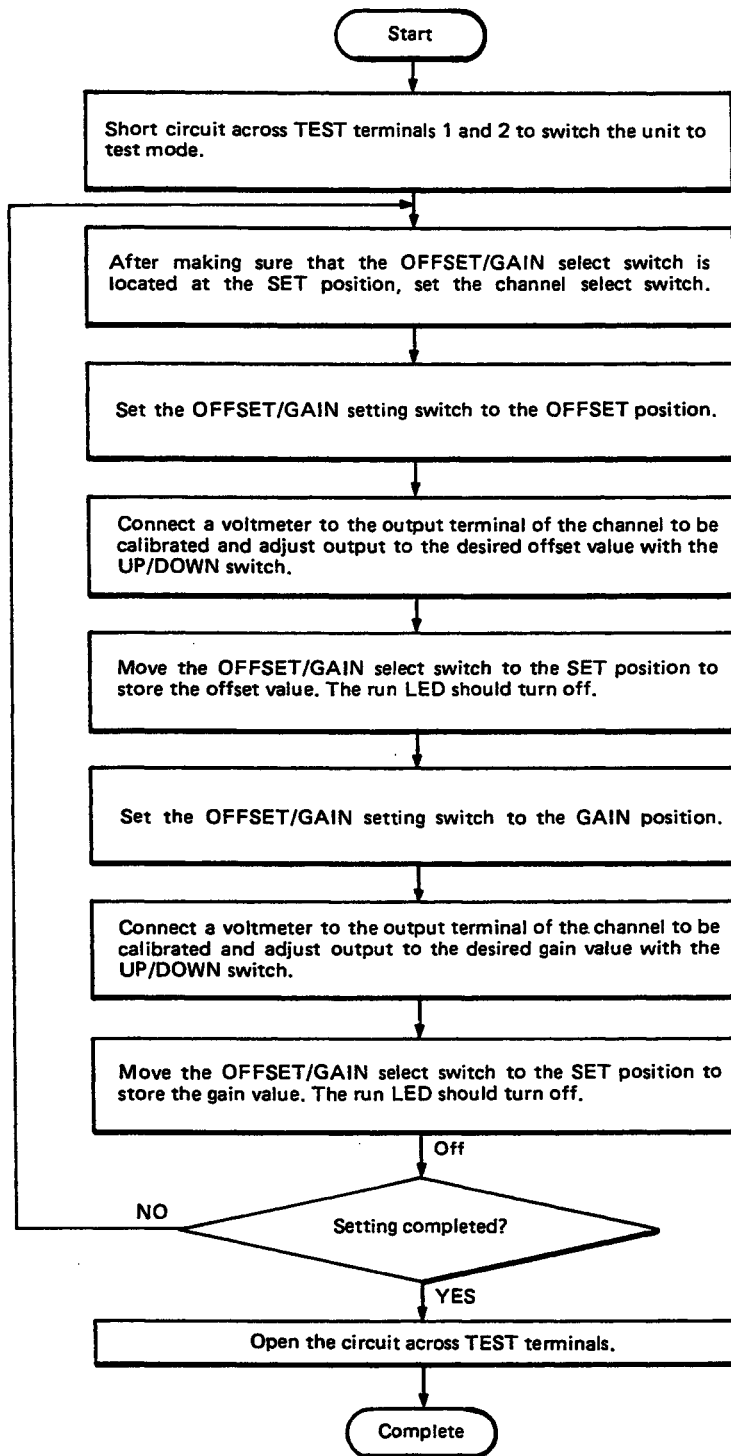

POINT

1. Do not set the A62DA to test mode during its normal control operation. All channels stop D/A conversion in test mode, normal control cannot be performed. By returning the A62DA to normal mode again, D/A conversion is resumed at the newly calibrated gain/offset setting. For the analog output value in test mode, refer to Section 3.3.2 (page 3-9).
2. Set the offset/gain value within the range -10 to 0 to +10V DC or from -20 to 0 to +20mA DC. If setting has been performed outside this range, maximum resolution and overall accuracy may not be within the range of performance specifications.
3. If the RUN LED flickers at high speed (5Hz) when the offset/gain setting range has been exceeded, this excessive value cannot be set into the A62DA and the previously set value is retained.
4. Always switch the OFFSET/GAIN switch to the SET position before switching between channels to prevent accidental over writing of set values.

IMPORTANT

If the CPU is reset in test mode with the OFFSET/GAIN select switch and UP/DOWN switch at the positions described below, proper D/A conversion cannot be made. Therefore, never reset the CPU with the above mentioned switches fixed at such positions. Should the CPU have been reset as described above, restore the system by opening the circuit across the test terminals or by resetting the programmable controller CPU with the switches in their normal positions.

OFFSET/GAIN Select Switch	UP/DOWN Switch	Phenomenon
OFFSET position	DOWN position	Watch dog timer error (X0) signal turns on and analog output is set to 0V (0mA).
GAIN position	DOWN position	Offset/gain setting cannot be performed.

6.2 Check Points before Start of Operation

Number	Checking Point	Description	Check
1	Loading of unit	Is the I/O assignment for the A62DA slot correct?	
2	Offset/gain setting	Has offset/gain setting been performed for all channels used?	
		Check for setting errors.	
		Has the unit been returned to normal mode by opening the circuit across TEST terminals?	
3	Connection to A62DA	Does the cable connected to each terminal of terminal block match a signal? Have cables been connected correctly?	
		Are the terminal screws on the terminal block tightened securely?	
		Is the cable size correct?	
		Is the 24V DC connected correctly?	

Table 7.2 Check Points

7. TROUBLESHOOTING

This chapter describes simple troubleshooting procedures for the A62DA. For the CPU module, refer to the CPU User's Manual.

7.1 Troubleshooting Flow Chart

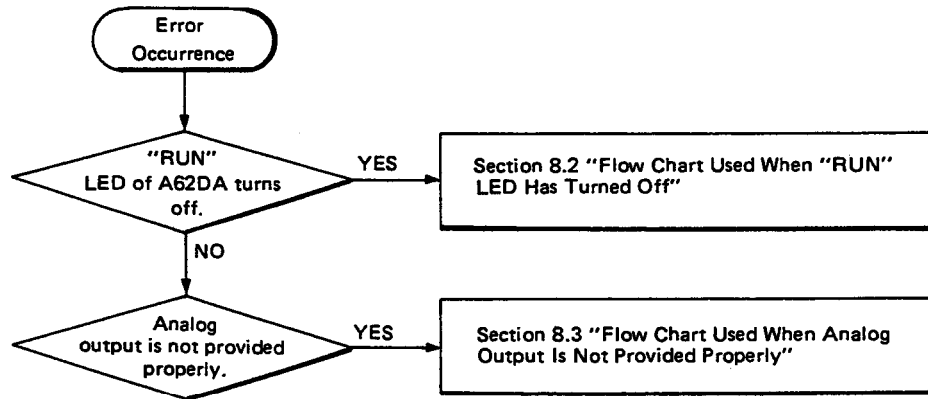

7.2 Flow Chart Used When "RUN" LED Has Flickered or Turned Off

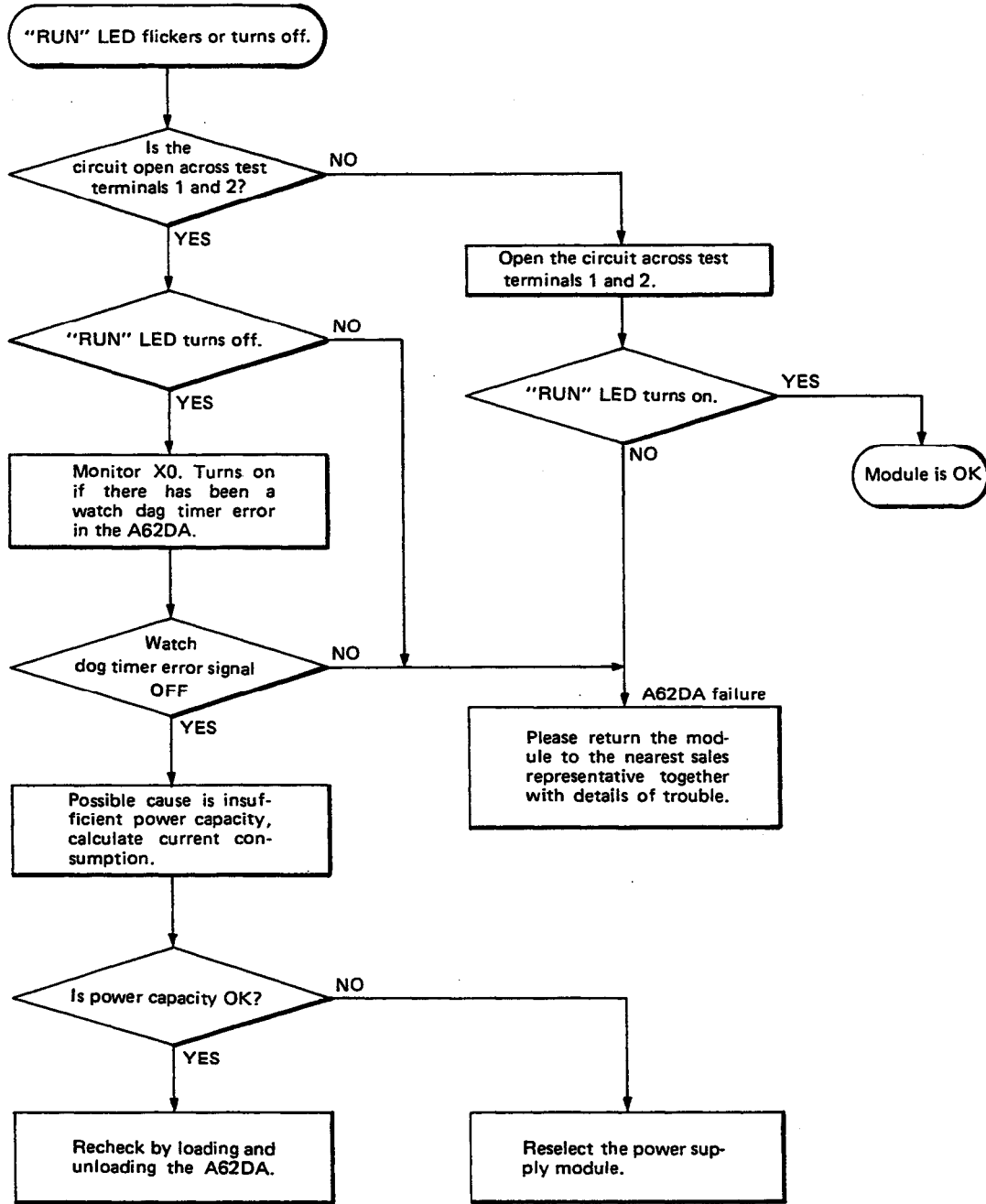

7.3 Flow Chart Used When Analog Output Is Not Provided Properly

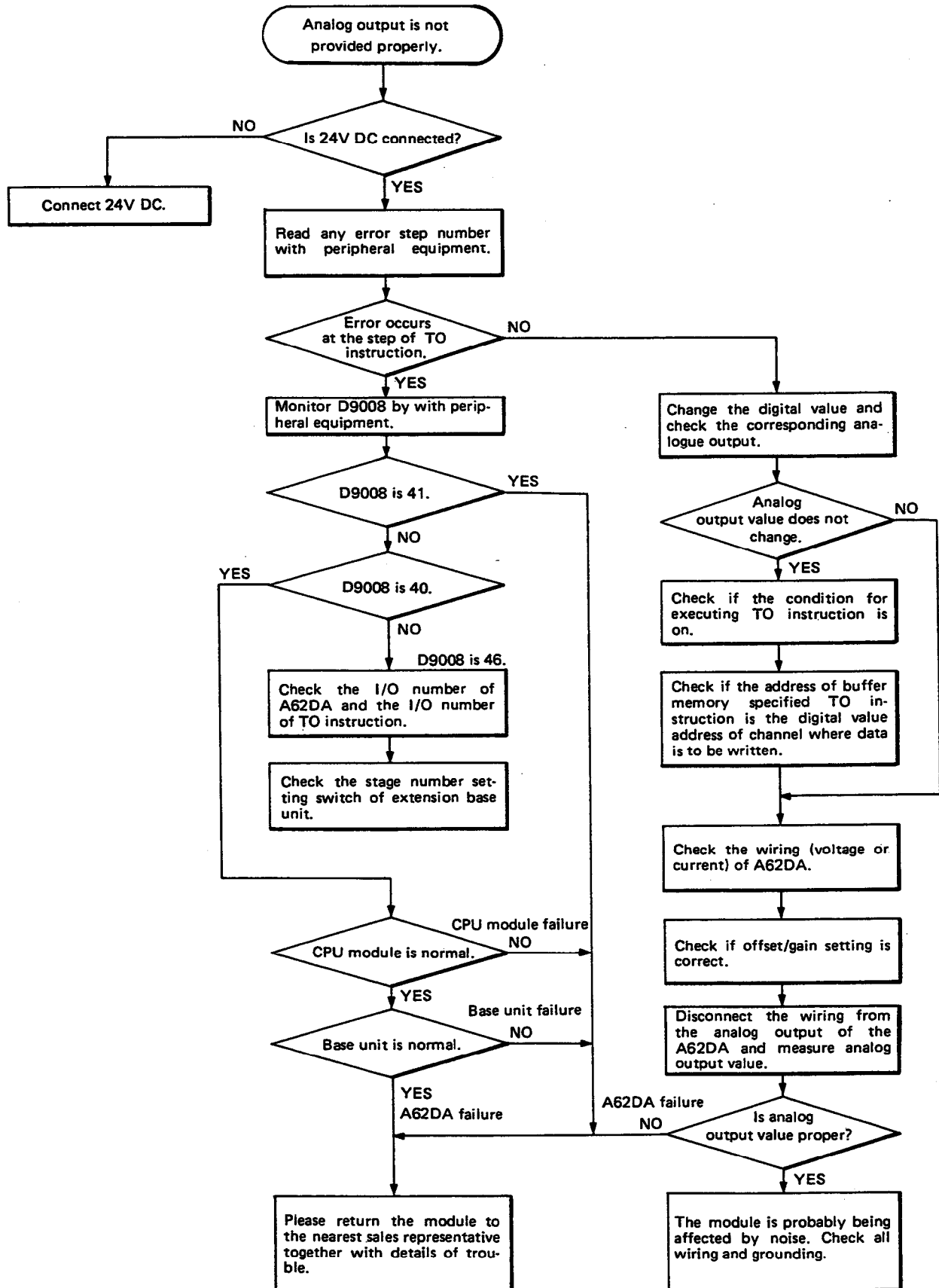

REMARKS

The following contents are written into D9008 when an error has occurred during execution of the FROM or TO instruction.

Content (BIN value) of Special Register D9008	CPU Status	Error and Cause
40	Stop	FROM and TO instructions cannot be executed. Hardware failure of A62DA (special function module), CPU unit, or base unit.
41	Stop	When the FROM or TO instruction has been executed, access has been made to the special function unit but no answer is returned. The accessed A62DA (special function module) has failed.
46	Stop (Continuous operation can be performed by the setting of parameter.)	Access has been made (FROM or TO instruction has been executed) to a slot where the A62DA (special function module) is not loaded. The content of FROM or TO instruction is incorrect or the stage number setting of extension base unit is improper.

APPENDIX

External View

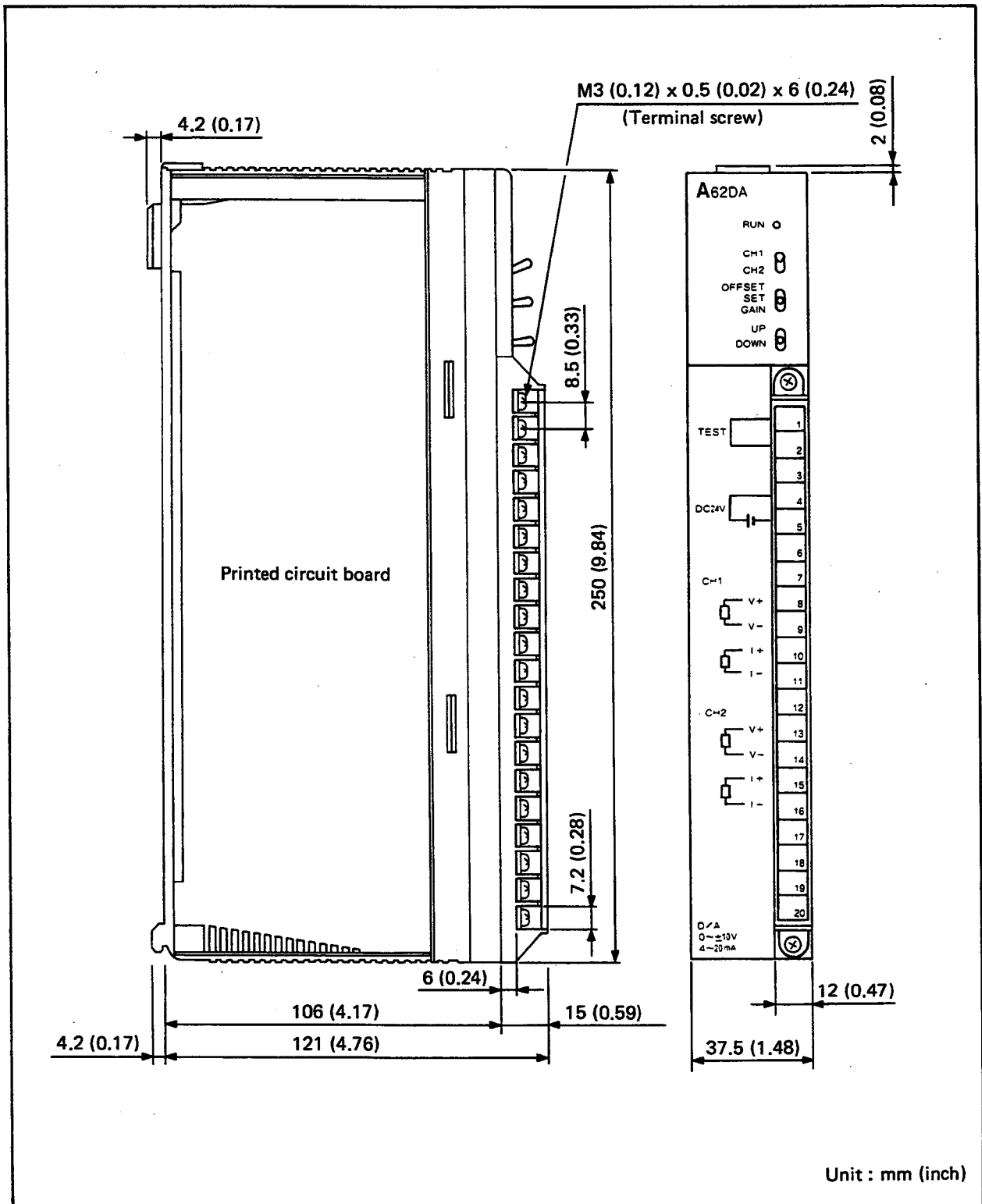

WARRANTY

Please confirm the following product warranty details before using this product.

1. Gratis Warranty Term and Gratis Warranty Range

If any faults or defects (hereinafter "Failure") found to be the responsibility of Mitsubishi occurs during use of the product within the gratis warranty term, the product shall be repaired at no cost via the sales representative or Mitsubishi Service Company.

However, if repairs are required onsite at domestic or overseas location, expenses to send an engineer will be solely at the customer's discretion. Mitsubishi shall not be held responsible for any re-commissioning, maintenance, or testing on-site that involves replacement of the failed module.

[Gratis Warranty Term]

The gratis warranty term of the product shall be for one year after the date of purchase or delivery to a designated place.

Note that after manufacture and shipment from Mitsubishi, the maximum distribution period shall be six (6) months, and the longest gratis warranty term after manufacturing shall be eighteen (18) months. The gratis warranty term of repair parts shall not exceed the gratis warranty term before repairs.

[Gratis Warranty Range]

- (1) The range shall be limited to normal use within the usage state, usage methods and usage environment, etc., which follow the conditions and precautions, etc., given in the instruction manual, user's manual and caution labels on the product.
- (2) Even within the gratis warranty term, repairs shall be charged for in the following cases.
 1. Failure occurring from inappropriate storage or handling, carelessness or negligence by the user. Failure caused by the user's hardware or software design.
 2. Failure caused by unapproved modifications, etc., to the product by the user.
 3. When the Mitsubishi product is assembled into a user's device, Failure that could have been avoided if functions or structures, judged as necessary in the legal safety measures the user's device is subject to or as necessary by industry standards, had been provided.
 4. Failure that could have been avoided if consumable parts (battery, backlight, fuse, etc.) designated in the instruction manual had been correctly serviced or replaced.
 5. Failure caused by external irresistible forces such as fires or abnormal voltages, and Failure caused by force majeure such as earthquakes, lightning, wind and water damage.
 6. Failure caused by reasons unpredictable by scientific technology standards at time of shipment from Mitsubishi.
 7. Any other failure found not to be the responsibility of Mitsubishi or that admitted not to be so by the user.

2. Onerous repair term after discontinuation of production

- (1) Mitsubishi shall accept onerous product repairs for seven (7) years after production of the product is discontinued. Discontinuation of production shall be notified with Mitsubishi Technical Bulletins, etc.
- (2) Product supply (including repair parts) is not available after production is discontinued.

3. Overseas service

Overseas, repairs shall be accepted by Mitsubishi's local overseas FA Center. Note that the repair conditions at each FA Center may differ.

4. Exclusion of loss in opportunity and secondary loss from warranty liability

Regardless of the gratis warranty term, Mitsubishi shall not be liable for compensation of damages caused by any cause found not to be the responsibility of Mitsubishi, loss in opportunity, lost profits incurred to the user by Failures of Mitsubishi products, special damages and secondary damages whether foreseeable or not, compensation for accidents, and compensation for damages to products other than Mitsubishi products, replacement by the user, maintenance of on-site equipment, start-up test run and other tasks.

5. Changes in product specifications

The specifications given in the catalogs, manuals or technical documents are subject to change without prior notice.

6. Product application

- (1) In using the Mitsubishi MELSEC programmable logic controller, the usage conditions shall be that the application will not lead to a major accident even if any problem or fault should occur in the programmable logic controller device, and that backup and fail-safe functions are systematically provided outside of the device for any problem or fault.
- (2) The Mitsubishi programmable logic controller has been designed and manufactured for applications in general industries, etc. Thus, applications in which the public could be affected such as in nuclear power plants and other power plants operated by respective power companies, and applications in which a special quality assurance system is required, such as for Railway companies or Public service purposes shall be excluded from the programmable logic controller applications.

In addition, applications in which human life or property that could be greatly affected, such as in aircraft, medical applications, incineration and fuel devices, manned transportation, equipment for recreation and amusement, and safety devices, shall also be excluded from the programmable logic controller range of applications.

However, in certain cases, some applications may be possible, providing the user consults their local Mitsubishi representative outlining the special requirements of the project, and providing that all parties concerned agree to the special circumstances, solely at the users discretion.

D/A Converter Module Type A62DA

User's Manual

MODEL	A62DA-USERS-E
MODEL CODE	13J608
IB(NA)-66053-E(0411)MEE	

 **MITSUBISHI ELECTRIC CORPORATION**

HEAD OFFICE : 1-8-12, OFFICE TOWER Z 14F HARUMI CHUO-KU 104-6212, JAPAN
NAGOYA WORKS : 1-14 , YADA-MINAMI 5-CHOME , HIGASHI-KU, NAGOYA , JAPAN

When exported from Japan, this manual does not require application to the Ministry of Economy, Trade and Industry for service transaction permission.

Specifications subject to change without notice.