

## Compact, Resistant to Mutual Interference, and Ideal for Picking a Variety of Parts.

- Mounts to a parts rack and uses indicators to show parts picking procedures. Functions as a mistake-proofing Sensor.
- Use either the built-in LED indicators or external picking indicators.



Be sure to read *Safety Precautions* on page 7.

## Features

### Sensing Distance of 3 m

### Selectable Display Mode: All Lighting, All Flashing, Elevator-like Lighting, Accordion-like Lighting

- Six picking indicators provide very clear displays.
- Selectable display speed (slow/fast)

All lit

All flashing

Elevator effect

Accordion effect

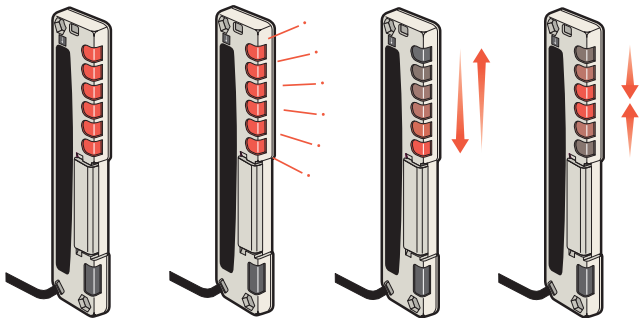

### External Picking Indicators Can Be Connected



An external indicator can be directly connected to the Picking Sensor and mounted in an easy-to-see location.



## Ordering Information

### Sensors

 Infrared LED



Sensing method	Appearance	Connection method (cable length)	Sensing distance		Beams		Sensing width (mm)	Output type	External indicator	Model
					Gap	Qty				
Through-beam		Pre-wired (5 m)		3 m	25 mm	5	100	NPN open collector	---	F3W-D052A *1
									Possible	F3W-D052AP *1
		Pre-wired connector (2 m)	---	F3W-D052B *1, 2						
			Possible	F3W-D052BP *1, 2						

\*1. Models with PNP outputs are also available. To order PNP Models, replace A with C in the model number for a Pre-wired Model and B with D in the model number for a Pre-wired Connector Model (Example: F3W-D052C).

\*2. The XS2F-D521-□G0 is the applicable connector cable. The colors of the external sheathes of the conductors, however, are different. Refer to the XS2.

### Accessories (Order Separately)

#### Mounting Brackets

Appearance	Model	Qty	Remarks
	F39-L10	two per set	L-shaped Mounting Bracket (mounting screws included)
	F39-L11	two per set	Flat Mounting Bracket (mounting screws included)

#### Protective Bracket

Appearance	Model	Qty
	F39-L12	One each for Emitter and Receiver (mounting screws included)

#### Y-shaped Joint Plugs and Sockets (Cable with Connectors on Both Ends)

Appearance	Overall length	Model	Qty
	2 m	XS2R-D526-S001-2	1
	5 m	XS2R-D526-S001-5	1

#### Y-shaped Joint Plugs and Sockets without Cable

Appearance	Model	Qty	Remarks
	XS2R-D526-S003	1	Connecting cable: <ul style="list-style-type: none"> <li>• Cable with connectors on both ends: XS2W Series</li> <li>• Cable with connector on one end: XS2F Series 4-conductor models</li> </ul>

# F3W-D

## Ratings and Specifications

Sensing method		Through-beam	
Item	Model	F3W-D052A (P) *1	F3W-D052B (P) *1
Sensing distance	3 m, switchable between LONG mode (1 to 3 m) and SHORT mode: (0.05 to 1 m), factory-set to SHORT mode.		
Beam gap	25 mm		
Number of beams	5		
Sensing width	100 mm		
Standard sensing object	Opaque, 35 mm dia. min.		
Light source (emission wavelength)	Infrared LED (860 nm)		
Power supply voltage	12 to 24 VDC±10% (ripple (p-p): 10% max.)		
Power consumption	Emitter: 0.6 W max., Receiver: 0.7 W max.		
Control output	NPN open collector with 100 mA max. at 30 VDC NPN open collector output type Dark-ON or Light-ON (selectable)		
Picking instruction indicator input	Open collector with relay or transistor input Indicator ON: Input voltage of 0 to 2 V Indicator OFF: Open (with leakage current of 0.1 mA max.)		
Protection circuits	Reverse-connection protection, output short protection, and mutual interference prevention function (set with frequency switch)		
Response time	Operate/Reset: 10 ms max.		
Indicators	Receiver	Operation indicator (orange), stability indicator (green), and 6 picking indicators (orange), UNI-WIRE Direct Connection Models: Transmission indicator (orange) *2	
	Emitter	Power indicator (green), different frequency indicator (green), and 6 picking indicators (orange), UNI-WIRE Direct Connection Models: Transmission indicator (orange) *2	
Ambient temperature	Operating: -10° to 55°C, Storage: -25° to 70°C (with no icing or condensation)		
Ambient humidity	35% to 85% (with no condensation)		
Insulation resistance	20 MΩ min. (at 500 VDC)		
Dielectric strength	1,000 VAC 50/60 Hz for 1 min		
Vibration resistance (destruction)	10 to 50 Hz, 1.5-mm double-amplitude for 2 hours each in X, Y and Z directions		
Shock resistance (destruction)	500 m/s <sup>2</sup> , 3 times each in X, Y and Z directions		
Degree of protection	IEC60529: IP62 (with the operation cover closed)		
Connection method	Pre-wired Standard cable length: 5 m *3		Pre-wired connector (M12 5-pin connector) Standard cable length: 2 m *3
Weight (packed state)	Approx. 360 g		Approx. 230 g
Materials	Case, indicator windows	ABS resin	
	Lens	Acrylic resin	
	Operation cover	Nylon (PA6)	
Accessories	Instruction manual		

\*1. The F3W-D052□P Emitters are provided with the external picking indicator output line shown in the following table.

Item	F3W-D052AP, F3W-D052BP
Connection method	Pre-wired (standard cable length: 300 mm)
Electrical specifications	Output current: 50 mA max. Output voltage: Fixed at Sensor power supply voltage

\*2. The transmission indicator indicates bus transmission status.

\*3. The following cable lengths are also available.

F3W-D052A (P): 2 m, 7 m  
F3W-D052B (P): 1 m, 3.5 m

# Engineering Data (Typical)

## Parallel Operating Range

### LONG Mode

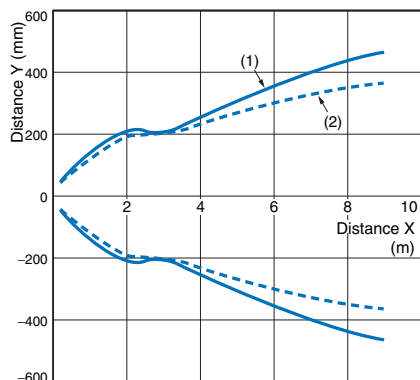

### SHORT Mode

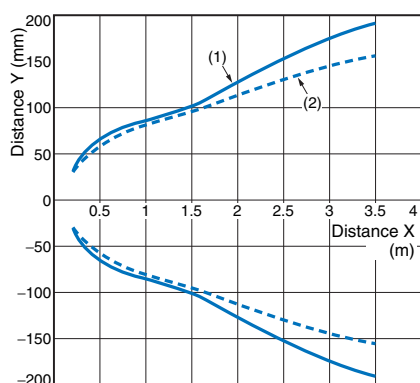

(1) Horizontal Movement Characteristics (2) Vertical Movement Characteristics

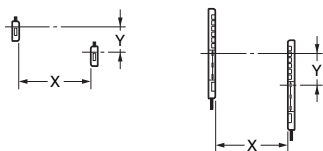

## Angle Characteristics

### LONG Mode: Tilt

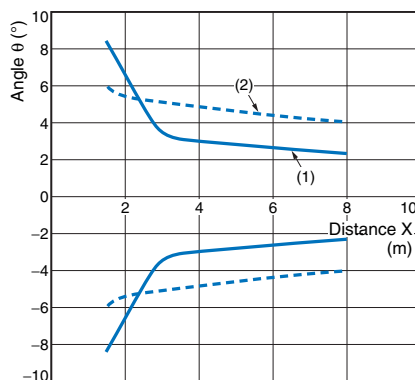

### SHORT Mode: Tilt

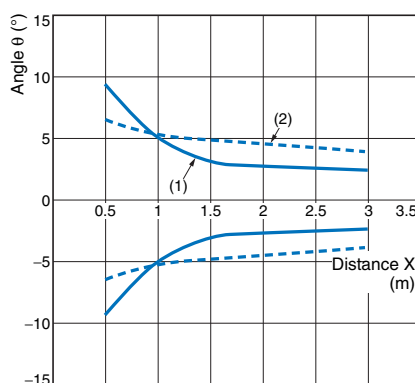

(1) Emitter Angle Characteristics (2) Receiver Angle Characteristics

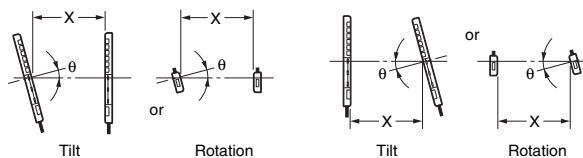

### LONG Mode: Rotation

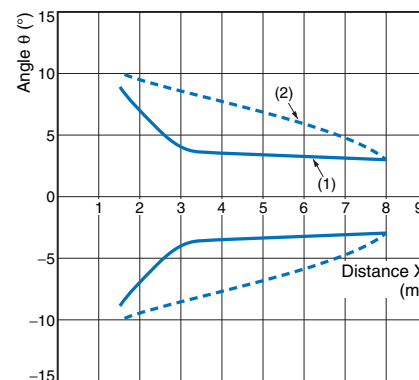

### SHORT Mode: Rotation

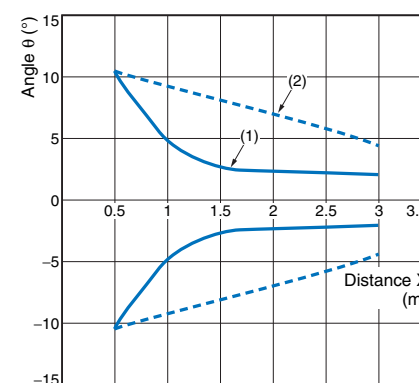

# F3W-D

## I/O Circuits

### NPN Open-collector Outputs

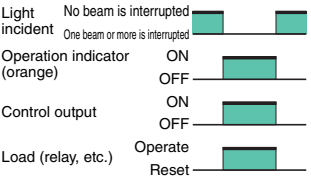
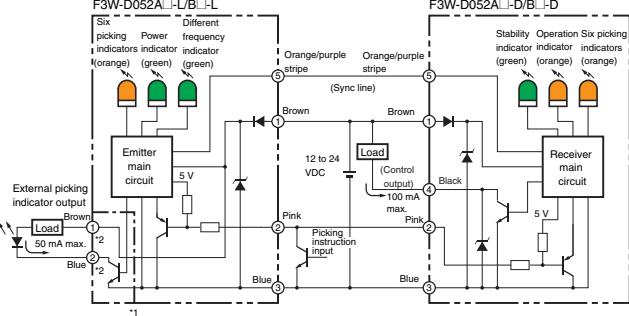
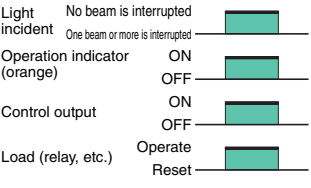
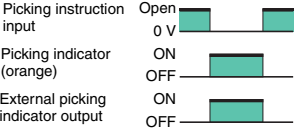
Model	Operation mode	Timing chart	Mode selector switch	Output circuit
F3W -D052A F3W -D052AP F3W -D052B F3W -D052BP	<b>Dark-ON mode</b>  ON: One beam or more is interrupted OFF: No beam is interrupted		<b>D-ON (DARK ON)</b>	 <p>Note: The circled numbers represent the pin numbers for Pre-wired Connector Models.</p> <p>*1. The sections surrounded by single-dashed lines are applicable to the F3W-D052AP-L/BP-L only.</p> <p>*2. The circled numbers represent external picking indicator output pin numbers.</p>
F3W -D052B F3W -D052BP	<b>Light-ON mode</b>  ON: No beam is interrupted OFF: One beam or more is interrupted		<b>L-ON (LIGHT ON)</b>	<p>The following diagram shows the relationship between the picking instruction input, picking indicator status, and external picking indicator output. DIP switch 1 is used to switch the picking display mode between all lighting, all flashing, elevator-like lighting, and accordion-like lighting. It is also possible to switch the external picking indicator display mode between lighting and flashing.</p> 

## Setting Method

### NPN Open-collector Output Models

#### DIP Switch 1 Mode Switching

##### Emitters

DIP switch 1	Function	OFF(left) ( <input type="checkbox"/> )	ON(right) ( <input checked="" type="checkbox"/> )
1	Flash Pattern (picking display mode setting)	See table below. *1	
2	Flash Time *2 (picking indicator flashing speed setting)	Slow	Fast
3	External Flash Pattern (external picking display mode setting) *3	Lit	Flashing
4	Not used.	---	---
5	Frequency Setting *4	A (frequency A)	B (frequency B)



##### Receivers

DIP switch 1	Function	OFF(left) ( <input type="checkbox"/> )	ON(right) ( <input checked="" type="checkbox"/> )
1	Flash Pattern (picking display mode setting)	See table below. *1	
2	Flash Time *2 (picking indicator flashing speed setting)	Slow	Fast
3	Operation mode setting	Dark-ON	Light-ON
4	Sensing distance (sensitivity) setting	LONG mode (1 to 3 m)	SHORT mode (0.05 to 1 m)
5	NC	---	---



\*1. DIP Switch 1 Picking Display Mode Setting

DIP switch 1	SW 1-1	SW 1-2	Display mode
	OFF	OFF	All lighting (All six indicators light.)
	ON	OFF	All flashing (All six indicators flash simultaneously.)
	OFF	ON	Elevator-like lighting (Two adjacent indicators simultaneously light so that lighting moves up and down.)
	ON	ON	Accordion-like lighting (Some or all indicators simultaneously light so that lighting moves like an accordion.)

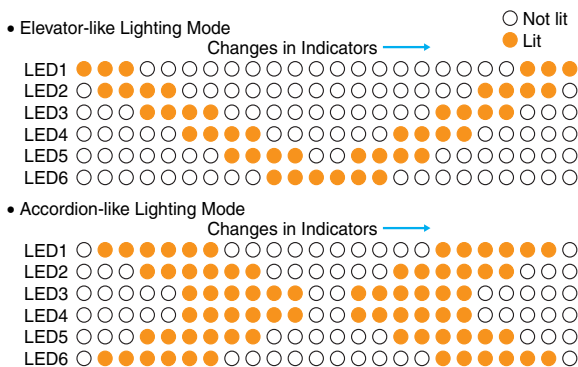

\*2. The flashing speed can be changed in picking display mode (all flashing, elevator-like lighting, or accordion-like lighting) or in external picking display mode. The flashing speed varies with each display mode.

\*3. This setting is supported for F3W-D052□P-L Emitters only.

\*4. Mutual Interference Prevention Function:

The frequency selector is used to switch the emitting frequency between A and B. Making the emitting frequencies of two Sensors different helps prevent malfunction caused by mutual interference.

# F3W-D

## Nomenclature

### NPN Open Collector Output Models

#### Emitter

F3W-D052A(P)-L  
F3W-D052B(P)-L

#### Receiver

F3W-D052A(P)-D  
F3W-D052B(P)-D

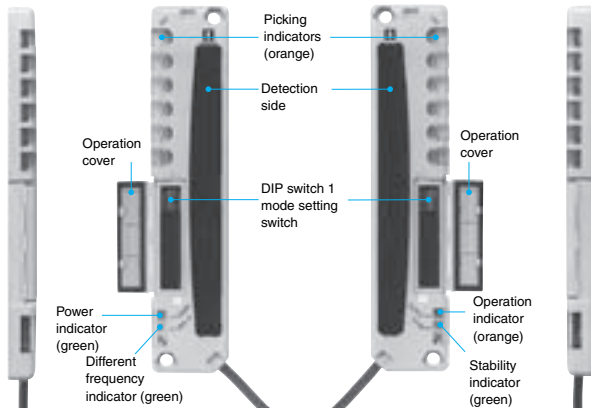

## Safety Precautions

Refer to *Warranty and Limitations of Liability*.

### WARNING

**Do not apply the F3W-D as safety mechanisms used in pressing machines or any other safety mechanisms for protecting the human body from danger.**



- (1) Do not apply the F3W-D as safety mechanisms used in pressing machines, shears, rolling machines, spinning machines, cotton mill machines, or robots for the protection of an operator's hands and body.
- (2) The F3W-D is designed for detection of the human body or moving objects in the detection area but not for protection against danger.
- (3) The F3W-D or any product incorporating the F3W-D may be exported to any country. Should the F3W-D cause any problem conflicting with local laws or related to product liability locally, however, OMRON shall, without exception, assume no responsibility for it.

### CAUTION

Before using more than one F3W-D Sensor in parallel or series, take necessary countermeasures against mutual interference so that the Sensors will not malfunction. Refer to *Mutual Interference Prevention Function* on the right.

### Precautions for Safe Use

#### ● Operating Environment

- Do not use the Sensor in an environment containing flammable or volatile gases.
- Do not use the Sensor underwater.
- Do not disassemble, repair, or modify the Sensor.
- Always turn OFF the system power before installing or replacing the Sensor.

### Precautions for Correct Use

Do not use the product in atmospheres or environments that exceed product ratings.

#### ● System Design

##### Mutual Interference Prevention Function

###### (1) Two Sets of Sensors:

Set these Sensors to different frequencies with the frequency selector. Refer to *DIP Switch 1 Mode Switching* on page 6. If the mutual interference prevention function is not used, and there are two Sensors with the same frequency setting, a beam from the Emitter of one Sensor may hit the Receiver of the other Sensor, resulting in malfunction.

This function cannot prevent mutual interference between the F3W-D Sensor and a Photoelectric Sensor of a different model.

###### (2) Three or More Sets of Sensors:

When 3 or more sets of Sensors are used in parallel, mutual interference may result in malfunction. Take the following measures to prevent mutual interference, and check for mutual interference. While in LONG mode, the Sensors are more easily affected by interference. Therefore, if the distance between the Emitter and Receiver of a Sensor is 1 m or less, use the SHORT mode.

- The distance between two adjacent sets of Sensors must be at least  $l_1$  or  $l_2$ , which does not cause mutual interference between two Sensors with the same frequency setting.  $l_1$  or  $l_2$  is at least 1.5 times the distance shown in Parallel Operating Range of the Engineering Data.

## Vertical Installation

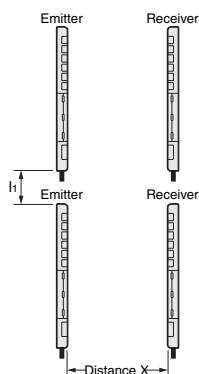

## Horizontal Installation

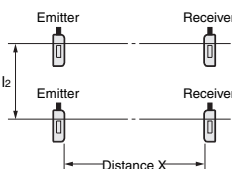

- Install a baffle so that there will not be mutual interference between Sensors with the same frequency setting. (See Figure 1.) A light reflection from the wall or floor may go around a baffle and reach the Receivers. Install a baffle so that it will also block any light reflection. (See Figure 2.)

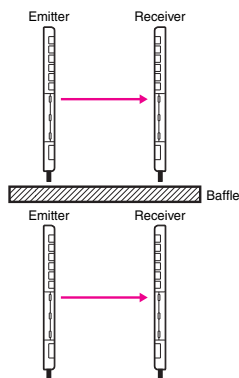

Figure 1

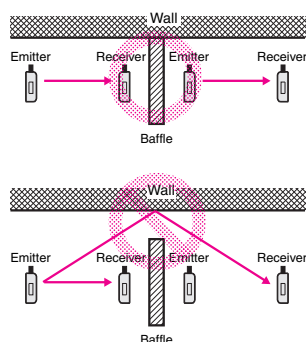

Figure 2

## Wiring Precautions

### Connection

- Before turning ON the power, make sure that the supply voltage is within the maximum allowable voltage range.
- Always connect the sync lines.
- Be very careful not to get metal chips in the connector, especially during wiring.
- Incorrect wiring may damage the equipment. Make sure that the cable length and routing are appropriate to prevent the connectors and cables from getting disconnected.
- Always leave the operation cover closed during operation.
- Applying excessive force to the mode switch may result in damage. Do not apply a force of more than 5 N.

### Cables

Make sure that the bending radius is 25 mm or more.

## Installation Precautions

### Installation

- Install the Sensor so that its sensing face will not receive light from the sun, fluorescent lamps, incandescent lamps, and other light sources.
- Do not strike the Sensor with a hammer or any other tool during installation, otherwise the internal circuits of the Sensor may be damaged.

- Install the Emitter and Receiver in the same orientation as shown in the following figure. (The cables must be in the same direction.)

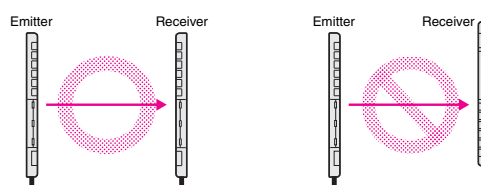

- Use M4 screws to secure the Sensor body.
- Secure the case to a tightening torque of 1.2 N·m or less.

## Reflection from Wall or Floor

If the Emitter and Receiver are installed as shown in the following illustration, all the axes may not be interrupted due to light reflection from the floor or wall. Make sure that the Emitter and Receiver detect the sensing object properly before using the F3W-D in actual operation.

### Side View

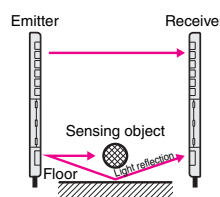

### Top View

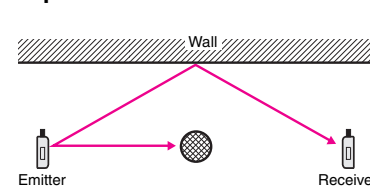

## Adjustment

### Operation and Stability Status Display

- The following illustration shows the indicator status corresponding to each incident level.
- Install the Receiver so that the green stability indicators are both ON in light receiving status.

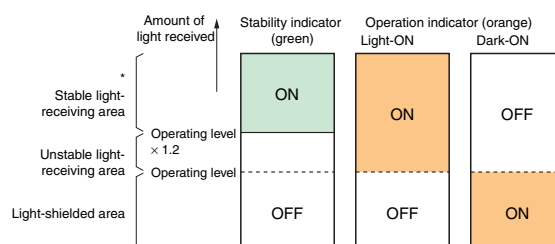

\* If the Receiver is set to the stable light-receiving area, it will become more resistant to environmental fluctuations such as temperature, voltage, dust, and setting deviation after installation. For applications where a stable light-receiving area is not obtained, attention must be paid to environmental fluctuations.

## Error Display

F3W-D052 Picking Sensors are provided with only one error display mode.

If an error occurs, the indicator on the Sensor's Receiver, as indicated by the arrow in the diagram on the right, will flash. The error indicated in this example is a synchronization error.

The possible causes are as follows:

- The sync line is not connected.
- The sync line is shorted with another line.

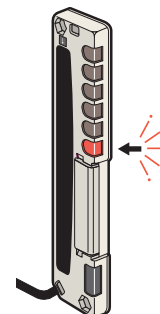



# F3W-D

## Dimensions

(Unit: mm)

### Sensors

#### F3W-D

#### Emitter

**F3W-D052A(P)-L**  
**F3W-D052B(P)-L**

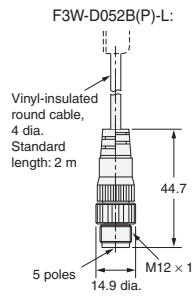

Two, M4 nut holes (Depth: 1 mm)

Vinyl-insulated round cable with four conductors, 4 dia.  
Conductor: 0.2 mm<sup>2</sup>  
Insulation: 1.1 mm dia.  
Standard length: 5 m

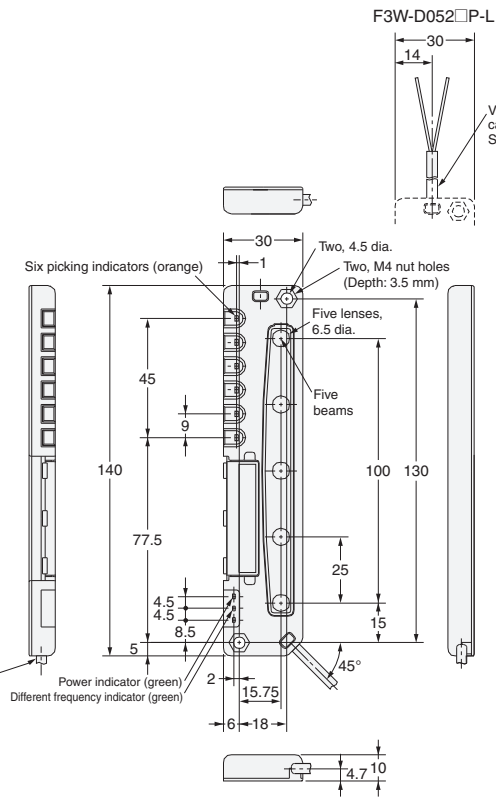

#### Mounting Hole Dimensions

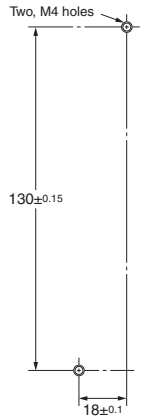

#### Receiver

**F3W-D052A(P)-D**  
**F3W-D052B(P)-D**

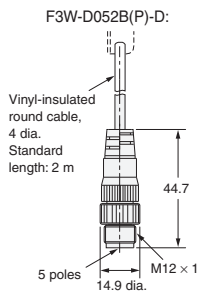

Two, M4 nut holes (Depth: 1 mm)

Vinyl-insulated round cable with five conductors, 4 dia.  
Conductor: 0.2 mm<sup>2</sup>  
Insulation: 1.1 mm dia.  
Standard length: 5 m

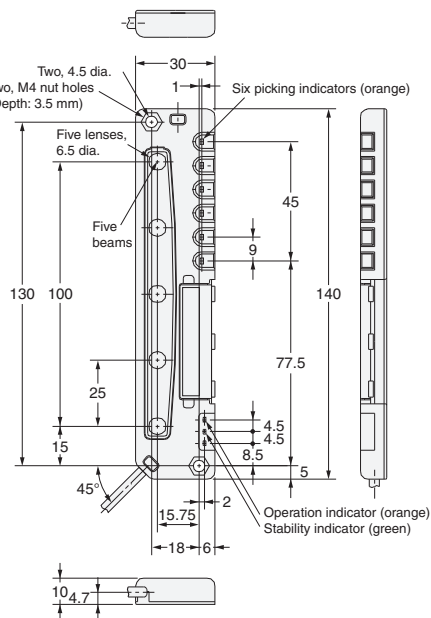

#### Mounting Hole Dimensions

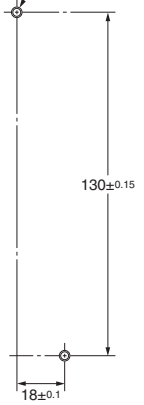

Accessories (Sold Separately)

Mounting Brackets

F39-L10(L-shaped)



Material: Iron  
(Thickness: 2 mm)  
Mounting screws provided.

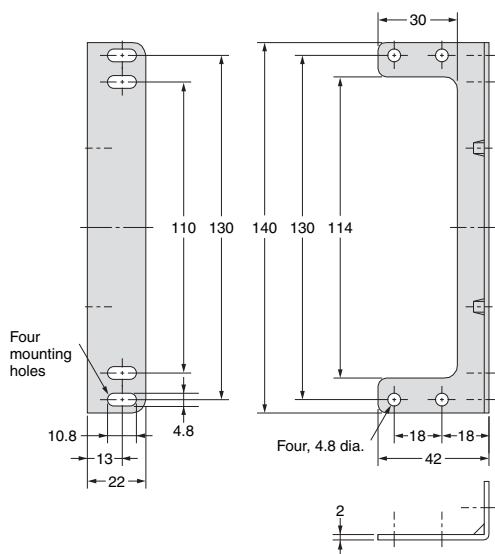

Mounting Bracket Attached

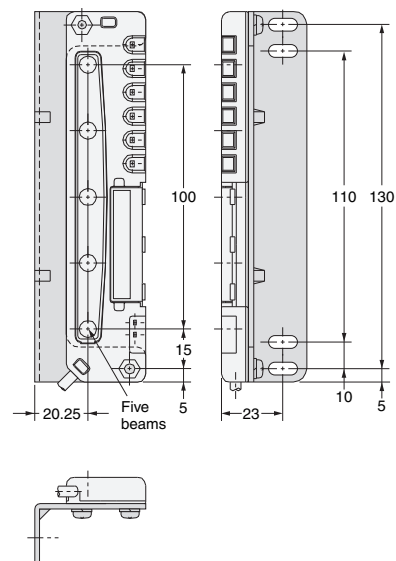

Mounting Brackets

F39-L11(Flat)



Material: Iron  
(Thickness: 2 mm)  
Mounting screws provided.

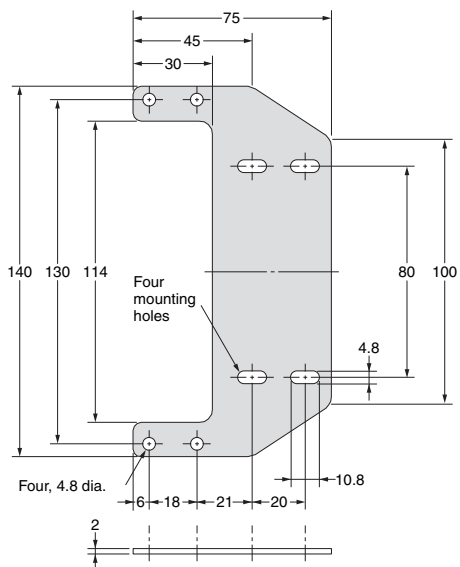

Mounting Bracket Attached

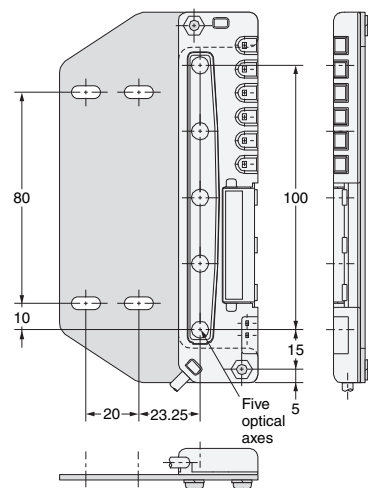

# F3W-D

## Protective Bracket

### F39-L12(Receiver)

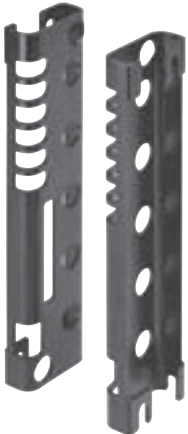

Material: Iron  
(Thickness: 1.6 mm)  
Mounting screws provided.

Note: The Emitter and Receiver are axially symmetrical.

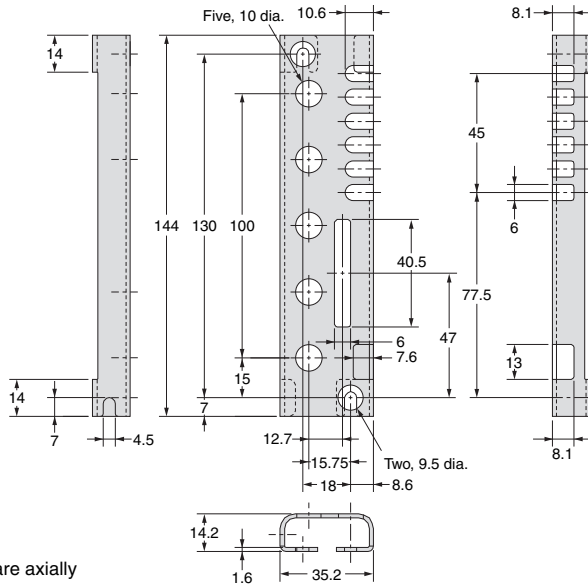

### Mounting Bracket Attached

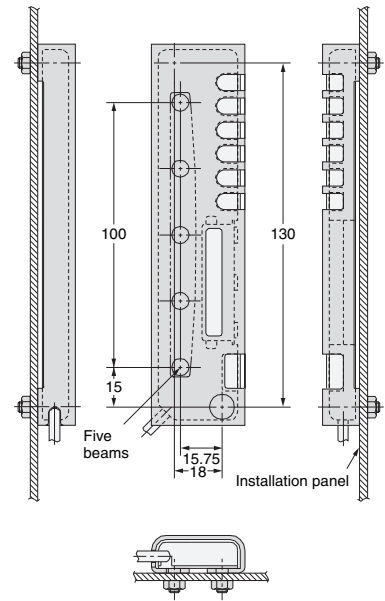

## Y-shaped Joint Plugs and Sockets (Cable with Connectors on Both Ends)

### XS2R-D526-S001-2 (L=2,000 mm)

### XS2R-D526-S001-5 (L=5,000 mm)

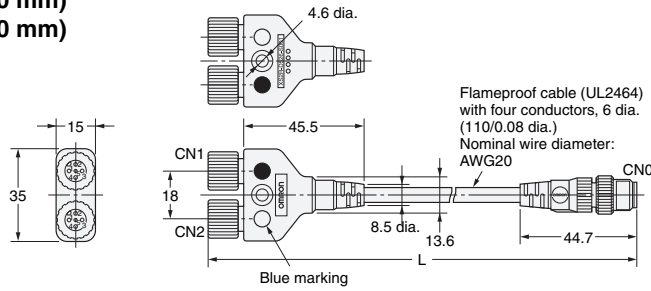

### Wiring Diagram

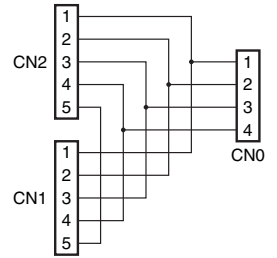

## Y-shaped Joint Plugs and Sockets without Cable

### XS2R-D526-S003

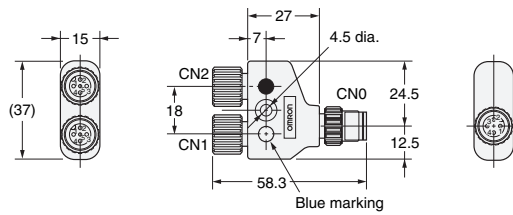

### Wiring Diagram

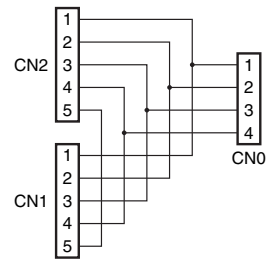

## Terms and Conditions Agreement

### Read and understand this catalog.

Please read and understand this catalog before purchasing the products. Please consult your OMRON representative if you have any questions or comments.

### Warranties.

(a) Exclusive Warranty. Omron's exclusive warranty is that the Products will be free from defects in materials and workmanship for a period of twelve months from the date of sale by Omron (or such other period expressed in writing by Omron). Omron disclaims all other warranties, express or implied.

(b) Limitations. OMRON MAKES NO WARRANTY OR REPRESENTATION, EXPRESS OR IMPLIED, ABOUT NON-INFRINGEMENT, MERCHANTABILITY OR FITNESS FOR A PARTICULAR PURPOSE OF THE PRODUCTS. BUYER ACKNOWLEDGES THAT IT ALONE HAS DETERMINED THAT THE PRODUCTS WILL SUITABLY MEET THE REQUIREMENTS OF THEIR INTENDED USE.

Omron further disclaims all warranties and responsibility of any type for claims or expenses based on infringement by the Products or otherwise of any intellectual property right. (c) Buyer Remedy. Omron's sole obligation hereunder shall be, at Omron's election, to (i) replace (in the form originally shipped with Buyer responsible for labor charges for removal or replacement thereof) the non-complying Product, (ii) repair the non-complying Product, or (iii) repay or credit Buyer an amount equal to the purchase price of the non-complying Product; provided that in no event shall Omron be responsible for warranty, repair, indemnity or any other claims or expenses regarding the Products unless Omron's analysis confirms that the Products were properly handled, stored, installed and maintained and not subject to contamination, abuse, misuse or inappropriate modification. Return of any Products by Buyer must be approved in writing by Omron before shipment. Omron Companies shall not be liable for the suitability or unsuitability or the results from the use of Products in combination with any electrical or electronic components, circuits, system assemblies or any other materials or substances or environments. Any advice, recommendations or information given orally or in writing, are not to be construed as an amendment or addition to the above warranty.

See <http://www.omron.com/global/> or contact your Omron representative for published information.

### Limitation on Liability; Etc.

OMRON COMPANIES SHALL NOT BE LIABLE FOR SPECIAL, INDIRECT, INCIDENTAL, OR CONSEQUENTIAL DAMAGES, LOSS OF PROFITS OR PRODUCTION OR COMMERCIAL LOSS IN ANY WAY CONNECTED WITH THE PRODUCTS, WHETHER SUCH CLAIM IS BASED IN CONTRACT, WARRANTY, NEGLIGENCE OR STRICT LIABILITY.

Further, in no event shall liability of Omron Companies exceed the individual price of the Product on which liability is asserted.

### Suitability of Use.

Omron Companies shall not be responsible for conformity with any standards, codes or regulations which apply to the combination of the Product in the Buyer's application or use of the Product. At Buyer's request, Omron will provide applicable third party certification documents identifying ratings and limitations of use which apply to the Product. This information by itself is not sufficient for a complete determination of the suitability of the Product in combination with the end product, machine, system, or other application or use. Buyer shall be solely responsible for determining appropriateness of the particular Product with respect to Buyer's application, product or system. Buyer shall take application responsibility in all cases.

NEVER USE THE PRODUCT FOR AN APPLICATION INVOLVING SERIOUS RISK TO LIFE OR PROPERTY OR IN LARGE QUANTITIES WITHOUT ENSURING THAT THE SYSTEM AS A WHOLE HAS BEEN DESIGNED TO ADDRESS THE RISKS, AND THAT THE OMRON PRODUCT(S) IS PROPERLY RATED AND INSTALLED FOR THE INTENDED USE WITHIN THE OVERALL EQUIPMENT OR SYSTEM.

### Programmable Products.

Omron Companies shall not be responsible for the user's programming of a programmable Product, or any consequence thereof.

### Performance Data.

Data presented in Omron Company websites, catalogs and other materials is provided as a guide for the user in determining suitability and does not constitute a warranty. It may represent the result of Omron's test conditions, and the user must correlate it to actual application requirements. Actual performance is subject to the Omron's Warranty and Limitations of Liability.

### Change in Specifications.

Product specifications and accessories may be changed at any time based on improvements and other reasons. It is our practice to change part numbers when published ratings or features are changed, or when significant construction changes are made. However, some specifications of the Product may be changed without any notice. When in doubt, special part numbers may be assigned to fix or establish key specifications for your application. Please consult with your Omron's representative at any time to confirm actual specifications of purchased Product.

### Errors and Omissions.

Information presented by Omron Companies has been checked and is believed to be accurate; however, no responsibility is assumed for clerical, typographical or proofreading errors or omissions.